



CFD General Notation System Standard Interface Data Structures

CGNS Version 3.3 (rev 2)

Abstract

The CFD General Notation System (CGNS) is a standard for recording and recovering computer data associated with the numerical solution of the equations of fluid dynamics. The intent is to facilitate the exchange of CFD data between sites, between applications codes, and across computing platforms, and to stabilize the archiving of CFD data. The CGNS system consists of a collection of conventions, and software implementing those conventions, for the storage and retrieval of CFD data. It consists of two parts: (1) a standard format for recording the data, and (2) software that reads, writes, and modifies data in that format. The format is a conceptual entity established by the documentation; the software is a physical product supplied to enable developers to access and produce data recorded in that format. The standard format, or paper convention, part of CGNS consists of two fundamental pieces. The first, known as the Standard Interface Data Structures, is described in this Recommended Practice. It defines the intellectual content of the information to be stored. The second, known as the File Mapping, defines the exact location in a CGNS file where the data is to be stored.

Contents

Abstract	iii
Overview	1
1 Introduction	3
1.1 Major Differences from Previous CGNS Versions	4
1.1.1 Version 3.3	5
1.1.2 Version 3.2	5
1.1.3 Version 3.1	5
1.1.4 Version 2.5	6
1.1.5 Version 2.4	6
1.1.6 Version 2.3	7
1.1.7 Version 2.2, Beta 1	7
1.1.8 Version 2.1, Beta 1	8
1.1.9 Version 2.0, Beta 2	8
1.1.10 Version 2.0, Beta 1	8
2 Design Philosophy of Standard Interface Data Structures	11
2.1 Implications of CFD Data Sets	11
2.2 Topologically Based Hierarchical Database	11
2.3 Additional Design Objectives	12
3 Conventions	15
3.1 Data Structure Notation Conventions	15
3.2 Structured Grid Notation and Indexing Conventions	19
3.3 Unstructured Grid Element Numbering Conventions	20
3.3.1 1-D (Line) Elements	22
3.3.2 2-D (Surface) Elements	23
3.3.2.1 Triangular Elements	23
3.3.2.2 Quadrilateral Elements	25
3.3.3 3-D (Volume) Elements	28
3.3.3.1 Tetrahedral Elements	28
3.3.3.2 Pyramid Elements	34
3.3.3.3 Pentahedral Elements	41
3.3.3.4 Hexahedral Elements	48
3.3.4 Unstructured Grid Example	55
3.4 Multizone Interfaces	57
4 Building-Block Structure Definitions	61
4.1 Definition: <code>DataClass_t</code>	61
4.2 Definition: <code>Descriptor_t</code>	61
4.3 Definition: <code>DimensionalUnits_t</code>	62
4.4 Definition: <code>DimensionalExponents_t</code>	63
4.5 Definition: <code>GridLocation_t</code>	64
4.6 Definition: <code>IndexArray_t</code>	64
4.7 Definition: <code>IndexRange_t</code>	65
4.8 Definition: <code>Rind_t</code>	65
5 Data-Array Structure Definitions	67

5.1	Definition: <code>DataArray_t</code>	67
5.1.1	Definition: <code>DataConversion_t</code>	68
5.2	Data Manipulation	69
5.2.1	Dimensional Data	69
5.2.2	Nondimensional Data Normalized by Dimensional Quantities	70
5.2.3	Nondimensional Data Normalized by Unknown Dimensional Quantities	70
5.2.4	Nondimensional Parameters	73
5.2.5	Dimensionless Constants	74
5.3	Data-Array Examples	74
6	Hierarchical Structures	79
6.1	CGNS Version	79
6.2	CGNS Entry Level Structure Definition: <code>CGNSBase_t</code>	79
6.2.1	Base Level Families	82
6.3	Zone Structure Definition: <code>Zone_t</code>	83
6.4	Precedence Rules and Scope Within the Hierarchy	87
6.4.1	Single Base	87
6.4.2	Multiple Bases	88
7	Grid Coordinates, Elements, and Flow Solutions	91
7.1	Grid Coordinates Structure Definition: <code>GridCoordinates_t</code>	91
7.2	Grid Coordinates Examples	93
7.3	Elements Structure Definition: <code>Elements_t</code>	96
7.4	Elements Examples	99
7.5	Axisymmetry Structure Definition: <code>Axisymmetry_t</code>	103
7.6	Rotating Coordinates Structure Definition: <code>RotatingCoordinates_t</code>	104
7.7	Flow Solution Structure Definition: <code>FlowSolution_t</code>	105
7.8	Flow Solution Example	109
7.9	Zone Subregion Structure Definition: <code>ZoneSubRegion_t</code>	111
7.10	Zone Subregion Examples	114
8	Multizone Interface Connectivity	119
8.1	Zonal Connectivity Structure Definition: <code>ZoneGridConnectivity_t</code>	119
8.2	1-to-1 Interface Connectivity Structure Definition: <code>GridConnectivity1to1_t</code>	120
8.3	1-to-1 Interface Connectivity Examples	123
8.4	General Interface Connectivity Structure Definition: <code>GridConnectivity_t</code>	125
8.5	General Interface Connectivity Examples	133
8.6	Grid Connectivity Property Structure Definition: <code>GridConnectivityProperty_t</code>	136
8.6.1	Periodic Interface Structure Definition: <code>Periodic_t</code>	136
8.6.2	Average Interface Structure Definition: <code>AverageInterface_t</code>	137
8.7	Overset Grid Holes Structure Definition: <code>OversetHoles_t</code>	138
9	Boundary Conditions	141
9.1	Boundary Condition Structures Overview	142
9.2	Zonal Boundary Condition Structure Definition: <code>ZoneBC_t</code>	143
9.3	Boundary Condition Structure Definition: <code>BC_t</code>	145
9.4	Boundary Condition Data Set Structure Definition: <code>BCDataSet_t</code>	149
9.5	Boundary Condition Data Structure Definition: <code>BCData_t</code>	151
9.6	Boundary Condition Property Structure Definition: <code>BCProperty_t</code>	152

9.6.1	Wall Function Structure Definition: <code>WallFunction_t</code>	153
9.6.2	Area Structure Definition: <code>Area_t</code>	153
9.7	Boundary Condition Type Structure Definition: <code>BCType_t</code>	154
9.8	Matching Boundary Condition Data Sets	158
9.9	Boundary Condition Specification Data	160
9.10	Boundary Condition Examples	162
10	Governing Flow Equations	171
10.1	Flow Equation Set Structure Definition: <code>FlowEquationSet_t</code>	171
10.2	Governing Equations Structure Definition: <code>GoverningEquations_t</code>	172
10.3	Model Type Structure Definition: <code>ModelType_t</code>	174
10.4	Thermodynamic Gas Model Structure Definition: <code>GasModel_t</code>	174
10.5	Molecular Viscosity Model Structure Definition: <code>ViscosityModel_t</code>	176
10.6	Thermal Conductivity Model Structure Definition: <code>ThermalConductivityModel_t</code>	178
10.7	Turbulence Structure Definitions	180
10.7.1	Turbulence Closure Structure Definition: <code>TurbulenceClosure_t</code>	180
10.7.2	Turbulence Model Structure Definition: <code>TurbulenceModel_t</code>	181
10.8	Thermal Relaxation Model Structure Definition: <code>ThermalRelaxationModelType_t</code>	184
10.9	Chemical Kinetics Structure Definition: <code>ChemicalKineticsModel_t</code>	185
10.10	Electromagnetics Structure Definitions	187
10.10.1	Electromagnetics Electric Field Model Structure Definition: <code>EMElectricFieldModel_t</code>	188
10.10.2	Electromagnetics Magnetic Field Model Structure Definition: <code>EMMagneticFieldModel_t</code>	189
10.10.3	Electromagnetics Conductivity Model Structure Definition: <code>EMConductivityModel_t</code>	190
10.11	Flow Equation Examples	191
11	Time-Dependent Flow	195
11.1	Iterative Data Structure Definitions	195
11.1.1	Base Iterative Data Structure Definition: <code>BaseIterativeData_t</code>	195
11.1.2	Zone Iterative Data Structure Definition: <code>ZoneIterativeData_t</code>	196
11.2	Rigid Grid Motion Structure Definition: <code>RigidGridMotion_t</code>	197
11.3	Arbitrary Grid Motion Structure Definition: <code>ArbitraryGridMotion_t</code>	199
11.4	Zone Grid Connectivities	202
11.5	Examples for Time-Dependent Flow	202
12	Miscellaneous Data Structures	209
12.1	Reference State Structure Definition: <code>ReferenceState_t</code>	209
12.2	Reference State Example	210
12.3	Convergence History Structure Definition: <code>ConvergenceHistory_t</code>	211
12.4	Discrete Data Structure Definition: <code>DiscreteData_t</code>	213
12.5	Integral Data Structure Definition: <code>IntegralData_t</code>	215
12.6	Family Data Structure Definition: <code>Family_t</code>	216
12.7	Geometry Reference Structure Definition: <code>GeometryReference_t</code>	218
12.8	Family Boundary Condition Structure Definition: <code>FamilyBC_t</code>	219
12.9	Family Boundary Condition Data Set Structure Definition: <code>FamilyBCDataSet_t</code>	220
12.10	User-Defined Data Structure Definition: <code>UserDefinedData_t</code>	221

12.11 Gravity Data Structure Definition: <code>Gravity_t</code>	222
13 Bibliography	225
Appendix A Conventions for Data-Name Identifiers	227
A.1 Coordinate Systems	227
A.2 Flowfield Solution	228
A.3 Turbulence Model Solution	236
A.4 Nondimensional Parameters	236
A.5 Characteristics and Riemann Invariants Based on 1-D Flow	238
A.6 Forces and Moments	238
A.7 Time-Dependent Flow	241
Appendix B Structured Two-Zone Flat Plate Example	243
B.1 Overall Layout	243
B.2 Grid Coordinates	245
B.3 Flowfield Solution	246
B.4 Interface Connectivity	248
B.5 Boundary Conditions	251
B.6 Global Reference State	254
B.7 Equation Description	256

List of Figures

1 Sample Topologically Based CFD Hierarchy	12
2 Example Unstructured Cube (Exploded View)	57
3 Structured-Grid Multizone Interface Types	58
4 Example Tetrahedral Grid	100
5 Example Interface for 1-to-1 Connectivity	124
6 Example Interface for Generalized Connectivity, Structured Grids	133
7 Example Interface for Generalized Connectivity, Unstructured Grids with <code>HEXA_8</code> Donor Cell	134
8 Example Interface for Generalized Connectivity, Unstructured Grids with <code>TRI_3</code> Donor Cell	135
9 Hierarchy for Boundary Condition Structures	143
10 Boundary Condition Implementation Levels	162
B.1 Two-Zone Flat Plate Test Case	243

List of Tables

1 Element Types in CGNS	21
2 Cell Connectivity for Example Unstructured Cube	55
3 Boundary Face Connectivity for Example Unstructured Cube	56
4 GridLocation Usage	107
5 GridLocation Usage with Zone Subregions	113
6 GridLocation Usage with BC Patches	146
7 Simple Boundary Condition Types	156
8 Compound Boundary Condition Types	158

9	Associated Boundary Condition Types and Usage Rules	159
10	Data-Name Identifiers for Perfect Gas	176
11	Data-Name Identifiers for Molecular Viscosity Models	177
12	Data-Name Identifiers for Thermal Conductivity Models	179
13	Data-Name Identifiers for Turbulence Closure	181
14	Data-Name Identifiers for Chemical Kinetics Models	186
15	Defined Names (Symbols) for Commonly Used Mixtures	187
16	Data-Name Identifiers for Electromagnetics Models	191
17	Data-Name Identifiers for Rigid Grid Motion	199
18	Data-Name Identifiers for Grid Velocity	201
19	Data-Name Identifiers for Reference State	210
20	GridLocation Usage with Discrete Data	214
A.1	Coordinate Systems	227
A.2	Data-Name Identifiers for Coordinate Systems	228
A.3	Data-Name Identifiers for Flow Solution Quantities	230
A.4	Data-Name Identifiers for Typical Turbulence Models	236
A.5	Data-Name Identifiers for Nondimensional Parameters	237
A.6	Characteristic Variables	238
A.7	Data-Name Identifiers for Characteristics and Riemann Invariants	238
A.8	Data-Name Identifiers for Forces and Moments	240
A.9	Data-Name Identifiers for Time-Dependent Flow	241

Overview

This document contains the Standard Interface Data Structures (SIDS) definitions for the CFD General Notation System (CGNS) project; this project was originally a NASA-funded contract under the AST program, but control has now been completely transferred to a public forum known as the CGNS Steering Committee.

The purpose of this document is to scope the information that should be communicated between various CFD application codes; the target is 3-D multizone, compressible Navier-Stokes analysis. Attention in this document is not focused on I/O routines or formats but on the precise description of data that should be present in the I/O of a CFD code or in a CFD database.

This document therefore contains a precise definition of information pertinent to a CGNS database. Specifically, the following information is addressed:

- grid coordinates and elements
- flow solution data, including nondimensional parameters
- multizone interface connectivity, including abutting and overset
- boundary conditions
- flow equation descriptions
- time-dependent flow
- reference states
- dimensional units and nondimensionalization information associated with data
- convergence history
- association to geometry definition
- topologically based hierarchical structures

Information is encoded into C-like data structures.

This document replaces (in whole) earlier versions. Major changes made to the document since its last release are outlined in [Section 1.1](#).

1 Introduction

CGNS (CFD General Notation System) is a collection of conventions, along with software implementing those conventions, for the storage and retrieval of CFD (computational fluid dynamics) data. The CGNS system is designed to facilitate the exchange of data between sites and applications, as well as to help stabilize the archiving of fluid dynamic data. In today's environment, it is important in many technical arenas to maintain detailed records of scientific computations. CGNS was designed to help promote a long-lasting and extensible standard for this purpose. Many companies and institutions choose to adopt the CGNS standard in order to increase productivity by (1) reducing the time required to translate between data created and used by different applications, and (2) increasing the quality, longevity, and re-usability of archived data.

The CGNS standard is a conceptual entity established by the documentation. The CGNS software is a physical product supplied to enable writing and reading data according to this standard. All CGNS software is completely free and open to anyone. By using the supplied software, it is relatively easy for users to adhere to most of the standard described in detail in this document.

The CGNS project originated during 1994 through a series of meetings that addressed improved transfer of NASA technology to industry. A principal impediment in this process was the disparity in I/O formats employed by various flow codes, grid generators, and other utilities, and CGNS was conceived as a means to promote "plug-and-play" CFD. An agreement was reached to develop CGNS at Boeing, under NASA Contract NAS1-20267, with active participation by a team of CFD researchers from NASA's Langley, Lewis (now Glenn), and Ames Research Centers, McDonnell Douglas Corporation (now part of Boeing), and Boeing Commercial Airplane Group. This team, which was joined by ICEM CFD Engineering Corporation of Berkeley, California in 1997, undertook the core of the development. However, in the spirit of creating a completely open and broadly accepted standard, all interested parties were encouraged to participate; the US Air Force and Arnold Engineering Development Center were notably present. From the beginning, the purpose was to develop a system that could be distributed freely, including all documentation, software and source code. This goal has now been fully realized; further, control of CGNS has been completely transferred to a public forum known as the CGNS Steering Committee.

The principal target is the data normally associated with compressible viscous flow (i.e., the Navier-Stokes equations), but the standard is also applicable to subclasses such as Euler and potential flows. The initial release addressed multi-zone grids, flow fields, boundary conditions, and zone-to-zone connection information, as well as a number of auxiliary items, such as non-dimensionalization, reference states, and equation set specifications. Extensions incorporated since then include unstructured mesh, connections to geometry definition, time-dependent flow, and support for multiple species and chemistry.

It is worth noting that extensibility is a fundamental design characteristic of the system, which in principal could be used for other disciplines of computational field physics, such as acoustics or electromagnetics, given the willingness of the cognizant scientific community to define the conventions.

The standard format, or paper convention, part of CGNS consists of two fundamental pieces. The first, known as the Standard Interface Data Structures (SIDS), describes in detail the intellectual content of the information to be stored. It defines, for example, the precise meaning of a "boundary

condition”. The second, known as the SIDS File Mapping, defines the exact location in a CGNS file where the data is to be stored.

The implementation, or software, part of CGNS likewise consists of two separate entities. CGNS files are read and written by a stand-alone database manager, either ADF (Advanced Data Format) or HDF (Hierarchical Data Format). The database manager implements a tree-like data structure, as a binary file. Since the format of this file is completely controlled by the database manager, and since ADF and HDF are both written in ANSI C (Fortran wrappers are provided), these files and the database manager itself are portable to any environment that supports ANSI C. Both ADF and HDF are available separately and constitute useful tools for the storage of large quantities of scientific data.

The underlying database manager, however, implements no knowledge of CFD or of the File Mapping. To simplify access to CGNS files, a second layer of software known as the Mid-Level Library is provided. This layer is in effect an API, or Application Programming Interface for CFD. The API incorporates knowledge of the CFD data structures, their meaning and their location in the file, enabling applications such as flow codes and grid generators to access the data in familiar terms. The API is therefore the piece of the CGNS system most visible to applications developers. Like the ADF and HDF database managers, the Mid-Level Library is written in ANSI C; all public API routines have Fortran counterparts.

This document presents the formal definition of the Standard Interface Data Structures (SIDS). [Section 2](#) presents the major design philosophies used to develop the CGNS database and the encoding of this database into the SIDS; this section also provides an overview of the database hierarchy. [Section 3](#) describes the C-like nomenclature conventions used to define the SIDS. This section also gives the conventions for structured grid indexing and unstructured element numbering, and the nomenclature for multizone interfaces. Low-level building-block structures are defined in [Section 4](#); these structures are used to define all higher-level structures. Structures for defining data arrays, including dimensional-units and nondimensional information, are presented in [Section 5](#). The top levels of the CGNS hierarchy are next defined in [Section 6](#). The following sections then fill out the remainder of the hierarchy: [Section 7](#) defines the grid-coordinate, elements, and flow-solution structures; [Section 8](#) defines the multizone interface connectivity structures; [Section 9](#) defines boundary-condition structures; [Section 10](#) defines structures for describing governing flow equations; [Section 11](#) defines structures related to time-dependent flows; and [Section 12](#) contains miscellaneous structures. Two appendices complete the document. [Appendix A](#) provides naming conventions for data contained within the CGNS database, and [Appendix B](#) contains a complete SIDS description of a structured-grid two-zone test case.

1.1 Major Differences from Previous CGNS Versions

The following items represent noteworthy alterations and additions to the SIDS in reverse chronological order. References to CPEX in the following refer to CGNS Proposals for Extension.¹

¹CPEX descriptions can be found at <http://cgns.github.io/Proposals.html>; last accessed 9/24/2015.

1.1.1 Version 3.3

The following changes were made for Version 3.3

- Added CPEX 0039 to define inter-base reference for multi-zone connectivities, families, and time dependent pointers to Zones and Families. A reference to a zone or a family can now have the pattern <base name>/<zone name> or <base name>/<family name> in order to refer to a zone or a family defined in another base. 65 characters are allowed for identifiers in another base. Base Level Families section added ([Section 6.2.1](#)). New subsection on Multiple Bases added ([Section 6.4.1](#)). Mention of use of 65 characters made in [Section 8.2](#) and [Section 8.4](#). Added note in [Section 12.10](#). New maximum character size of 65 in ZonePointers and FamilyPointers in BaseIterativeData_t ([Section 11.1.1](#)).
- Added mention that FamilyName and AdditionalFamilyName in ZoneSubRegion_t must respect appropriate rules ([Section 7.9](#)).
- Added “.” to be avoided in names in [Section 3.1](#), and added mention that entity names cannot exceed 32 characters.
- Added mention that default value for SimulationType is SimulationTypeNull ([Section 6.2](#)).
- Added a note in [Section 7.7](#) to mention that the NODE element is not to be used in place of the vertex.
- Added some new subsection headings.
- Fixed typo in section 10.3 (GasModelType_t changed to ModelType_t).

1.1.2 Version 3.2

The following changes were made for Version 3.2

- Added AdditionalFamilyName_t under BC_t ([Section 9.3](#)), Zone_t ([Section 6.3](#)), ZoneSubRegion_t ([Section 7.9](#)), and UserDefinedData_t ([Section 12.10](#)); and added FamilyName_t under Family_t ([Section 12.6](#)) (a hierarchy of families is now possible); according to CPEX 0033 and 0034.
- Added new cubic elements in [Section 3.3](#), according to CPEX 0036.
- Added new quartic elements in [Section 3.3](#), according to CPEX 0038.

1.1.3 Version 3.1

The following changes were made for Version 3.1

- Added a PYRA_13 element in the description of the unstructured grid element numbering conventions for pyramid elements ([Section 3.3.3](#)).

- Modified the description of the `Elements_t` structure to incorporate the new definition of the `NGON_n` element type, and added the `NFACE_n` element type. Also added examples illustrating their use, including for polyhedral elements ([Section 7.3](#)).
- References to `Null` were changed to `xxxxNull`, and references to `UserDefined` were changed to `xxxxUserDefined`, as appropriate. Also made sure that the `xxxxNull` is listed first, and the `xxxxUserDefined` is listed second.
- Added section Model Type Structure Definition ([Section 10.3](#)).
- Added `ZoneSubRegion_t` (CPEX 0030) ([Section 7.9](#)). Made changes associated with CPEX 0031: (1) added `CellDimension` to several places in `Zone_t`, (2) added new `ParentElements` and `ParentElementsPosition` in `Elements_t`, (3) added `CellDimension` and revamped usage of `PointList` and `PointRange` in `FlowSolution_t`, (4) added `CellDimension` to several places in `ZoneBC_t`, (5) added `CellDimension` and revamped usage of `PointList` and `PointRange` in `BC_t`, (6) changes in `BCDataSet_t`, (7) added `CellDimension` and revamped usage of `PointList` and `PointRange` in `DiscreteData_t`, (8) changes in `FamilyBC_t`, (9) creation of new `FamilyBCDataSet_t`, (10) changes in Zone Grid Connectivities, and (11) addition of `ZoneGridConnectivityPointers` and `ZoneSubRegionPointers` in `ZoneIterativeData_t`. A note regarding CPEX 0031: The use of `ElementList` and `ElementRange` has been deprecated in favor of `PointList` and `PointRange`, as described in CPEX 0031 and in relevant sections of this document.
- Added clarity that if rotating about more than one axis, then it is done in a particular order in `Periodic_t` and in Data-Name Identifiers for Rigid Grid Motion. ([Table 17](#))
- Modified table in [Section 9.3](#) to include `CellCenter GridLocation`.

1.1.4 Version 2.5

No changes were made to the data structures for Version 2.5.

1.1.5 Version 2.4

The following changes were made for Version 2.4.

- `GridLocation_t`, `PointRange`, and `PointList` have been added to the `BCDataSet_t` data structure, allowing boundary conditions to be specified at locations different from those used to define the BC patch. (E.g., a BC patch may be defined using vertices, with boundary conditions applied at face centers.) ([Section 9.4](#)).
- Data structures have been added to `FlowEquationSet_t` for describing the electric field, magnetic field, and conductivity models used for electromagnetic flows. Corresponding recommended data-name identifiers have also been added. ([Section 10.1](#) and [Section 10.10](#)).
- `RotatingCoordinates_t` has been added to the `Family_t` data structure. ([Section 12.6](#)).

- A `BCDataSet_t` list has been added to the `FamilyBC_t` data structure, allowing specification of boundary condition data arrays for CFD families. ([Section 12.8](#)).
- `GridLocation_t`, `PointRange`, `PointList`, `FamilyName_t`, `UserDefinedData_t`, and `Ordinal` have been added to the `UserDefinedData_t` data structure. ([Section 12.10](#)).
- The `DimensionalUnits_t` and `DimensionalExponents_t` structures have been expanded to include units for electric current, substance amount, and luminous intensity. ([Section 4.3](#)).
- The capability to include rind data with unstructured grids has been added, and `Rind_t` has been added to the `Elements_t` structure, allowing specification of connectivity information for rind elements. ([Section 4.8](#)).

1.1.6 Version 2.3

The following changes were made for Version 2.3.

- `ElementRange` and `ElementList` have been added to the `BC_t` data structure. `ElementRange` or `ElementList` may now be used to define a boundary condition patch by specifying face indices, instead of using `PointRange` or `PointList` with `GridLocation` set to `FaceCenter`. The use of `PointRange` or `PointList` to define a boundary condition patch hasn't changed. They may be used to define a boundary condition patch by specifying either vertex or face indices.

When `PointRange` or `PointList` is used, the choice between vertex or face indices is determined by the value of `GridLocation_t`. When `ElementRange` or `ElementList` is used, `GridLocation_t` is ignored ([Section 9.3](#)).

1.1.7 Version 2.2, Beta 1

The following changes were made for Version 2.2, Beta 1.

- `Axisymmetry_t` and `RotatingCoordinates_t` nodes have been added, allowing the recording of data relevant to axisymmetric flows and rotating coordinates ([Section 7.5](#) and [Section 7.6](#)).
- A `Gravity_t` node has been added for storage of the gravitational vector ([Section 12.11](#)).
- A `GridConnectivityProperty_t` node has been added, allowing the recording of special properties associated with particular connectivity patches, such as periodic interfaces, or interfaces where the data is to be averaged in some way prior to passing it to a neighboring interface ([Section 8.6](#)).
- A `BCProperty_t` node has been added, allowing the recording of special properties associated with particular boundary condition patches, such as wall function or bleed regions ([Section 9.6](#)).
- Additional flow solution data-name identifiers are included for variables in rotating coordinate systems ([Appendix A.2](#)).

1.1.8 Version 2.1, Beta 1

The following changes were made for Version 2.1, Beta 1.

- A node type `UserDefinedData_t` ([Section 12.10](#)) is added for the storage of arbitrary user defined data in `Descriptor_t` and `DataArray_t` children without the restrictions or implicit meanings imposed on these node types at other node locations.
- Support for multi-species flows and chemistry has been added. New gas models have been added to the `GasModelType_t` enumeration ([Section 10.4](#)), and `ThermalRelaxationModel_t` and `ChemicalKineticsModel_t` data structures have been added for describing the thermal relaxation and chemical kinetics models ([Section 10.8](#) and [Section 10.9](#)). Additional flow solution data-name identifiers are included ([Appendix A.2](#)).

1.1.9 Version 2.0, Beta 2

The following changes were made for Version 2.0, Beta 2.

- The following data structures related to time-dependent flow have been added: `BaseIterativeData_t` ([Section 11.1.1](#)), `ZoneIterativeData_t` ([Section 11.1.2](#)), `RigidGridMotion_t` ([Section 11.2](#)), `ArbitraryGridMotion_t` ([Section 11.3](#)).

1.1.10 Version 2.0, Beta 1

The following changes were made for Version 2.0, Beta 1.

- The capability for recording unstructured zones has been added to the SIDS. (These changes occur throughout the document, although some specific items are listed below.)
- The values `UserDefined` and `Null` are now allowed for all enumeration types (throughout document).
- The following nodes are now defined (some of these also include additional new children sub-nodes): `Family_t` ([Section 12.6](#)), `Elements_t` ([Section 7.3](#)), `ZoneType_t` ([Section 6.3](#)), `FamilyName_t` ([Section 6.3](#)), `GeometryReference_t` ([Section 12.7](#)), `FamilyBC_t` ([Section 12.8](#)).
- Under `CGNSBase_t`, the `IndexDimension` is no longer recorded; it has been replaced by `CellDimension` and `PhysicalDimension` ([Section 6.2](#)).
- Under `Zone_t`, the optional parameter `VertexSizeBoundary` has been added for unstructured zones ([Section 6.3](#)).
- The method for general connectivity (`GridConnectivity_t`) has been altered. It now requires the use of either (a) `PointListDonor` (an integer, for `Abutting1to1` only) or (b) `CellListDonor` (an integer) plus `InterpolantsDonor` (a real) ([Section 8.4](#)).

- The `GridLocation_t` parameter has been moved up one level (from `BCDataSet_t` to `BC_t`). Thus, for example, if the boundary conditions are defined at vertices (the default), then any associated dataset information must also be specified at vertices ([Section 9.3](#) and [Section 9.4](#)).
- The data-name identifier `LengthReference` has been added ([Section 12.1](#) and [Appendix A.2](#)).
- The ν_t parameter has been renamed `ViscosityEddyKinematic`, and a new parameter `ViscosityEddy`, representing μ_t , has been defined ([Appendix A.2](#)).

2 Design Philosophy of Standard Interface Data Structures

The major design goal of the SIDS is a comprehensive and unambiguous description of the “intellectual content” of information that must be passed from code to code in a multizone Navier-Stokes analysis system. This information includes grids, flow solutions, multizone interface connectivity, boundary conditions, reference states and dimensional units or normalization associated with data.

2.1 Implications of CFD Data Sets

The goal is description of the data sets typical of CFD analysis, which tend to contain a small number of extremely large data arrays. This has a number of implications for both the design of the SIDS and the ultimate physical files where the data resides. The first is that any I/O system built for CFD analysis must be designed to efficiently store and process large data arrays. This is reflected in the SIDS, which includes provisions for describing large data arrays.

The second implication is that the nature of the data sets allows for thorough description of the data with relatively little storage overhead and performance penalty. For example, the flow solution of a CFD analysis may contain several millions of quantities. Therefore, with little penalty it is possible to include information describing the flow variables stored, their location in the grid, and dimensional units or nondimensionalization associated with the data. The SIDS take advantage of this situation and includes an extensive description of the information stored in the database.

The third implication of CFD data sets is that files containing a CFD database are almost always required to be binary – ASCII storage of CFD data involves excessive storage and performance penalties. This means the files are not readable by humans and the information contained in them is not directly modifiable by text editors and such. This is reflected in the syntax of the SIDS, which tends to be verbose and thorough; whereas, directly modifiable ASCII file formats would tend to foster a more brief syntax.

It is important to note that the description of information by the SIDS is independent of physical file formats. However, it is targeted toward implementation using the ADF Core library. Some of the language components used to define the SIDS are meant to directly map into elements of an ADF node.

2.2 Topologically Based Hierarchical Database

An early decision in the CGNS project was that any new CFD I/O standard should include a hierarchical database, such as a tree or directed graph. The SIDS describe a hierarchical database, precisely defining both the data and their hierarchical relationships.

There are two major alternatives to organizing a CFD hierarchy: topologically based and data-type based. In a topologically based graph, overall organization is by zones; information pertaining to a particular zone, including its grid coordinates or flow solution, hangs off the zone. In a data-type based graph, organization is by related data. For example, there would be two nodes at the same level, one for grid coordinates and another for the flow solution. Hanging off each of these nodes would be separate lists of the zones.

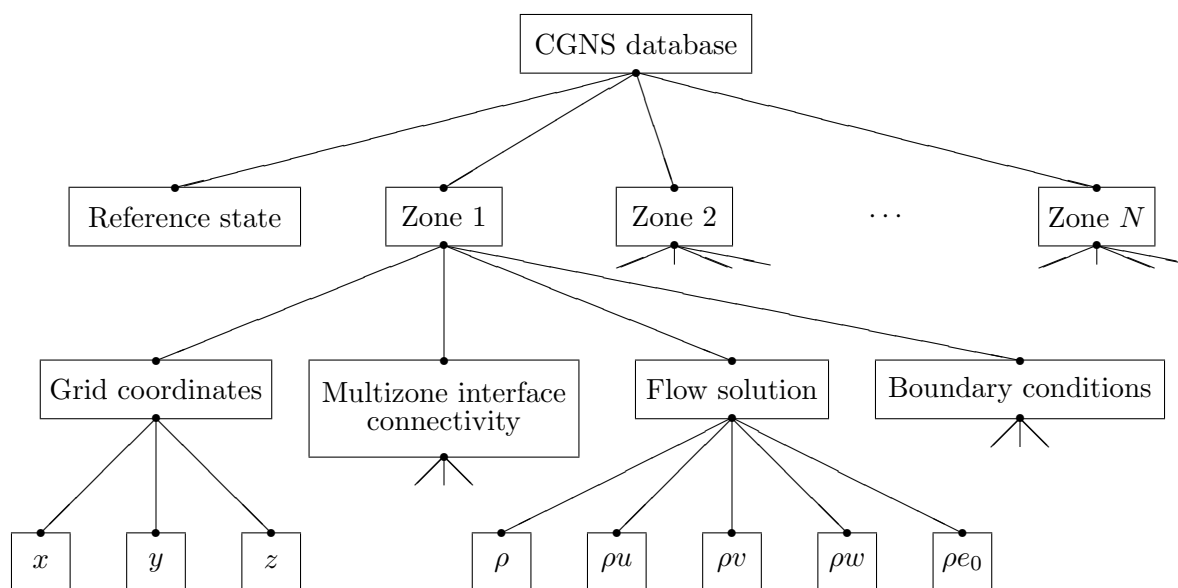

Figure 1: Sample Topologically Based CFD Hierarchy

The hierarchy described in this document is topologically based; a simplified illustration of the database hierarchy is shown in [Figure 1](#). Hanging off the root “node” of the database is a node containing global reference-state information, such as freestream conditions, and a list of nodes for each zone. The figure shows the nodes that hang off the first zone; similar nodes would hang off of each zone in the database. Nodes containing the physical-coordinate data arrays (x , y and z) for the first zone are shown hanging off the “grid coordinates” node. Likewise, nodes containing the first zone’s flow-solution data arrays hang off the “flow solution” node. The figure also depicts nodes containing multizone interface connectivity and boundary condition information for the first zone; subnodes hanging off each of these are not pictured.

2.3 Additional Design Objectives

The data structures comprising the SIDS are the result of several additional design objectives:

One objective is to minimize duplication of data within the hierarchy. Many parameters, such as the grid size of a zone, are defined in only one location. This avoids implementation problems arising from data duplication within the physical file containing the database; these problems include simultaneous update of all copies and error checking when two copies of a data quantity are found to be different. One consequence of minimizing data duplication is that information at lower levels of the hierarchy may not be completely decipherable without access to information at higher levels. For example, the grid size is defined in the zone structure (see [Section 6.3](#)), but this parameter is needed in several substructures to define the size of grid and flow-solution data arrays. Therefore, these substructures are not autonomous and deciphering information within them requires access to information contained in the zone structure itself. The SIDS must reflect this cascade of information within the database.

Another objective is elimination of nonsensical descriptions of the data. The SIDS have been

carefully developed to avoid data qualifiers and other optional descriptive information that could be inconsistent. This has led to the use of specialized structures for certain CFD-related information. One example is a single-purpose structure for defining physical grid coordinates of a zone. It is possible to define the grid coordinates, flow solution and any other field quantities within a zone by a generic discrete-data structure. However, this requires the generic structure to include information defining the grid location of the data (e.g., the data is located at vertices or cell centers). Using the generic structure to describe the grid coordinates leads to a possible inconsistency. By definition the physical coordinates that define the grid are located at vertices, and including an optional qualifier that states otherwise makes no sense.

A final objective is to allow documentation inclusion throughout the database. The SIDS contain a uniform documentation mechanism for all major structures in the hierarchy. However, this document establishes no conventions for using the documentation mechanism.

3 Conventions

3.1 Data Structure Notation Conventions

The intellectual content of the CGNS database is defined in terms of C-like notation including typedefs and structures. The database is made up of entities, and each entity has a type associated with it. Entities include such things as the dimensionality of the grid, an array of grid coordinates, or a zone that contains all the data associated with a given region. Entities are defined in terms of types, where a type can be an integer or a collection of elements (a structure) or a hierarchy of structures or other similar constructs.

The terminology “instance of an entity” is used to refer to an entity that has been assigned a value or whose elements have been assigned values. The terminology “specific instance of a structure” is also used in the following sections. It is short for an instance of an entity whose type is a structure.

Names of entities and types are constructed using conventions typical of *Mathematica*.² Names or identifiers contain no spaces and capitalization is used to distinguish individual words making up a name; names are case-sensitive. The character “/” should be avoided in names, as well as the names “.” and “..”, as these have special meaning when referencing elements of a structure entity. An entity name cannot exceed 32 characters.

The following notational conventions are employed:

!	comment to end of line
_t	suffix used for naming a type
;	end of a definition, declaration, assignment or entity instance
=	assignment (takes on the value of)
:=	indicates a type definition (typedef)
[]	delimiters of an array
{ }	delimiters of a structure definition
{ { } }	delimiters of an instance of a structure entity
< >	delimiters of a structure parameter list
int	integer
real	floating-point number
char	character
bit	bit
Enumeration()	indicates an enumeration type
Data()	indicates an array of data, which may be multidimensional
List()	indicates a list of entities
Identifier()	indicates an entity identifier
LogicalLink()	indicates a logical link
/	delimiter for element of a structure entity
../	delimiter for parent of a structure entity
(r)	designation for a required structure element
(o)	designation for an optional structure element
(o/d)	designation for an optional structure element with default if absent

²*Mathematica 3.0*, Wolfram Research, Inc., Champaign, IL (1996)

An enumeration type is a set of values identified by names; names of values within a given enumeration declaration must be unique. An example of an enumeration type is the following:

```
Enumeration( Dog, Cat, Bird, Frog )
```

This defines an enumeration type which contains four values.

`Data()` identifies an array of given dimensionality and size in each dimension, whose elements are all of a given data type. It is written as,

```
Data( DataType, Dimension, DimensionValues[] ) ;
```

`Dimension` is an integer, and `DimensionValues[]` is an array of integers of size `Dimension`. `Dimension` and `DimensionValues[]` specify the dimensionality of the array and its size in each dimension. `DataType` specifies the data type of the array's elements; it may consist of one of the following: `int`, `real`, `char` or `bit`. For multidimensional arrays, FORTRAN indexing conventions are used. `Data()` is formulated to map directly onto the data section of an ADF node.

A typedef establishes a new type and defines it in terms of previously defined types. Types are identified by the suffix “_t”, and the symbol “:=” is used to establish a type definition (or typedef). For example, the above enumeration example can be used in a typedef:

```
Pet_t := Enumeration( Dog, Cat, Bird, Frog ) ;
```

This defines a new type `Pet_t`, which can then be used to declare a new entity, such as,

```
Pet_t MyFavoritePet ;
```

By the above typedef and declaration, `MyFavoritePet` is an entity of type `Pet_t` and can have the values `Dog`, `Cat`, `Bird` or `Frog`. A specific instance of `MyFavoritePet` is setting it equal to one of these values (e.g., `MyFavoritePet = Bird`).

A structure is a type that can contain any number of elements, including elements that are also structures. An example of a structure type definition is:

```
Sample_t :=  
  {  
    int Dimension ;                               (r)  
  
    real[4] Vector ;                               (o)  
  
    Pet_t ObnoxiousPet ;                           (o)  
  } ;
```

where `Sample_t` is the type of the structure. This structure contains three elements, `Dimension`, `Vector` and `ObnoxiousPet`, whose types are `int`, `real[4]` and `Pet_t`, respectively. The type `int` specifies an integer, and `real[4]` specifies an array of reals that is one-dimensional with a length of four. The “(r)” and “(o)” notation in the right margin is explained below. Given the definition of `Sample_t`, entities of this type can then be declared (e.g., `Sample_t Sample1;`). An example of an instance of a structure entity is given by,

```
Sample_t Sample1 =  
  {{  
    Dimension = 3 ;  
    Vector = [1.0, 3.45, 2.1, 5.4] ;  
    ObnoxiousPet = Dog ;  
  }} ;
```

Note the different functions played by single braces “{” and double braces “{{”. The first is used to delimit the definition of a structure type; the second is used to delimit a specific instance of a structure entity.

Some structure type definitions contain arbitrarily long lists of other structures or types. These lists will be identified by the notation,

```
List( Sample_t Sample1 ... SampleN ) ;
```

where `Sample1 ... SampleN` is the list of structure names or identifiers, each of which has the type `Sample_t`. Within each list, the individual structure names are user-defined.

In the CGNS database it is sometimes necessary to reference the name or identifier of a structure entity. References to entities are denoted by `Identifier()`, whose single argument is a structure type. For example,

```
Identifier(Sample_t) SampleName ;
```

declares an entity, `SampleName`, whose value is the identifier of a structure entity of type `Sample_t`. Given this declaration, `SampleName` could be assigned the value `Sample1` (i.e., `SampleName = Sample1`).

It is sometimes convenient to directly identify an element of a specific structure entity. It is also convenient to indicate that two entities with different names are actually the same entity. We borrow UNIX conventions to indicate both these features, and make the analogy that a structure entity is a UNIX directory and its elements are UNIX files. An element of an entity is designated by “/”; an example is `Sample1/Vector`). The structure entity that a given element belongs to is designated “../” A UNIX-like logical link that specifies the sameness of two apparently different entities is identified by `LogicalLink()`; it has one argument. An example of a logical link is as follows: Suppose a specific instance of a structure entity contains two elements that are of type `Sample_t`; call them `SampleA` and `SampleB`. The statement that `SampleB` is actually the same entity as `SampleA` is,

```
SampleB = LogicalLink(..SampleA) ;
```

The argument of `LogicalLink()` is the UNIX-like “path name” of the entity with which the link is made. In this document, `LogicalLink()` and the direct specification of a structure element via “/” and “../” are actually seldom used. These language elements are never used in the actual definition of a structure type.

Structure type definitions include three additional syntactic/semantic notions. These are parameterized structures, structure-related functions, and the identification of required and optional fields within a structure.

As previously stated, one of our design objectives is to minimize duplication of information within the CGNS database. To meet this objective, information is often stored in only one location of the hierarchy; however, that information is typically used in other parts of the hierarchy. A consequence of this is that it may not be possible to decipher all the information associated with a given entity in the hierarchy without knowledge of data contained in higher level entities. For example, the grid size of a zone is stored in one location (in `Zone_t`, see [Section 6.3](#)), but is needed in many substructures to define the size of grid and solution-data arrays.

This organization of information must be reflected in the language used to describe the database. First, parameterized structures are introduced to formalize the notion that information must be passed down the hierarchy. A given structure type is defined in terms of a list of parameters that precisely specify what information must be obtained from the structure's parent. These structure-defining parameters play a similar role to subroutine parameters in C or FORTRAN and are used to define fields within the structure; they are also passed onto substructures. Parameterized structures are also loosely tied to templates in C++.

Parameterized structures are identified by the delimiters `< >` enclosing the list of parameters. Each structure parameter in a structure-type definition consists of a type and an identifier. Examples of parameterized structure type definitions are:

```
NewSample_t< int Dimension, int Fred > :=
{
  int[Dimension] Vector ;                               (o)

  Pet_t ObnoxiousPet ;                                 (o)

  Stuff_t<Fred> Thingy ;                               (o)
} ;

Stuff_t< int George > :=
{
  real[George] IrrelevantStuff ;                       (r)
} ;
```

`NewSample_t` and `Stuff_t` are parameterized structure types. `Dimension` and `Fred` are the structure parameters of `NewSample_t`. `George` is the structure parameter of `Stuff_t`. All structure parameters in this example are of type `int`. `Thingy` is a structure entity of type `Stuff_t`; it uses the parameter `Fred` to complete its declaration. Note the use of `George` and `Fred` in the above example. `George` is a parameter in the definition of `Stuff_t`; `Fred` is an argument in the declaration of an entity of type `Stuff_t`. This mimics the use of parameters in function definitions in C.

A second language feature required to cope with the cascade of information within the hierarchy is structure-related functions. For example, the size of an array within a given structure may be a function of one or more of the structure-defining parameters, or the array size may be a function of

an optional field within the structure. No new syntax is provided to incorporate structure-related functions; they are instead described in terms of their return values, dependencies, and functionality.

An additional notation used in structure typedefs is that each element or field within a structure definition is identified as required, optional, or optional with a default if absent; these are designated by “(r)”, “(o)”, and “(o/d)”, respectively, in the right margin of the structure definition. These designations are included to assist in implementation of the data structures into an actual database and can be used to guide mapping of data as well as error checking. “Required” fields are those essential to the interpretation of the information contained within the data structure. “Optional” fields are those that are not necessary but potentially useful, such as documentation. “Defaulted-optional” fields are those that take on a known default if absent from the database.

In the example of `Sample_t` above, only the element `Dimension` is required. Both elements `Vector` and `ObnoxiousPet` are optional. This means that in any specific instance of the structure, only `Dimension` must be present. An alternative instance of the entity `Sample1` shown above is the following:

```
Sample_t Sample1 =
  {{
    Dimension = 4 ;
  }} ;
```

None of the entities and types defined in the above examples are actually used in the definition of the SIDS.

As a final note, the reader should be aware that the SIDS is a conceptual description of the form of the data. The actual location of data in the file is determined by the file mapping, defined by the appropriate *File Mapping Manual*.

3.2 Structured Grid Notation and Indexing Conventions

A *grid* is defined by its vertices. In a 3-D structured grid, the volume is the ensemble of cells, where each cell is the hexahedron region defined by eight nearest neighbor vertices. Each cell is bounded by six faces, where each face is the quadrilateral made up of four vertices. An edge links two nearest-neighbor vertices; a face is bounded by four edges.

In a 2-D structured grid, the notation is more ambiguous. Typically, the quadrilateral area composed of four nearest-neighbor vertices is referred to as a cell. The sides of each cell, the line linking two vertices, is either a face or an edge. In a 1-D grid, the line connecting two vertices is a cell.

A *structured multizone grid* is composed of multiple regions called *zones*, where each zone includes all the vertices, cells, faces, and edges that constitute the grid in that region.

Indices describing a 3-D grid are ordered (i, j, k) ; (i, j) is used for 2-D and (i) for 1-D.

Cell centers, face centers, and edge centers are indexed by the minimum i , j , and k indices of the connecting vertices. For example, a 2-D cell center (or face center on a 3-D grid) would have the following convention:

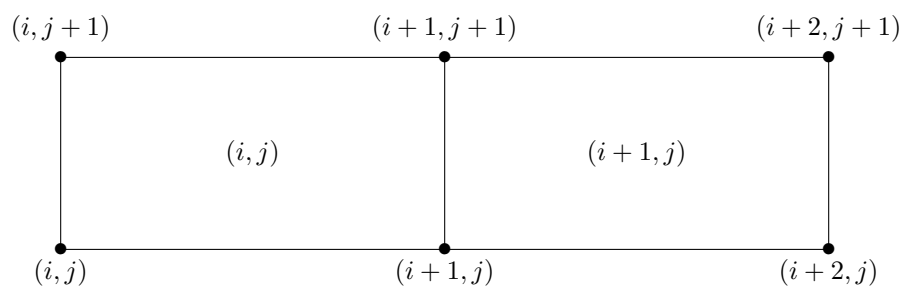

In addition, the default beginning vertex for the grid in a given zone is $(1, 1, 1)$; this means the default beginning cell center of the grid in that zone is also $(1, 1, 1)$.

A zone may contain grid-coordinate or flow-solution data defined at a set of points outside the zone itself. These are referred to as “rind” or ghost points and may be associated with fictitious vertices or cell centers. They are distinguished from the vertices and cells making up the grid within the zone (including its boundary vertices), which are referred to as “core” points. The following is a 2-D zone with a single row of rind vertices at the minimum and maximum i -faces. The grid size (i.e., the number of core vertices in each direction) is 5×4 . Core vertices are designated by “•”, and rind vertices by “×”. Default indexing is also shown for the vertices.

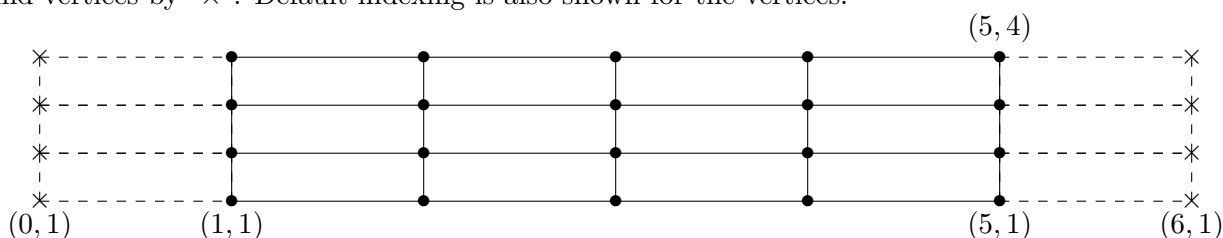

For a zone, the minimum faces in each coordinate direction are denoted i -min, j -min and k -min; the maximum faces are denoted i -max, j -max and k -max. These are the minimum and maximum core faces. For example, i -min is the face or grid plane whose core vertices have minimum i index (which if using default indexing is 1).

3.3 Unstructured Grid Element Numbering Conventions

The major difference in the way structured and unstructured grids are recorded is the element definition. In a structured grid, the elements can always be recomputed easily using the computational coordinates, and therefore they are usually not written in the data file. For an unstructured grid, the element connectivity cannot be easily built, so this additional information is generally added to the data file. The element information typically includes the element type or shape, and the list of nodes for each element.

In an unstructured zone, the nodes are ordered from 1 to N , where N is the number of nodes in the zone. An element is defined as a group of one or more nodes, where each node is represented by its index. The elements are indexed from 1 to M within a zone, where M is the total number of elements defined for the zone.

CGNS supports eight element shapes — points, lines, triangles, quadrangles, tetrahedra, pentahedra, pyramids, and hexahedra. Elements describing a volume are referred to as 3-D elements.

Those defining a surface are 2-D elements. Line and point elements are called 1-D and 0-D elements, respectively.

In a 3-D unstructured mesh, the cells are defined using 3-D elements, while the boundary patches may be described using 2-D elements. The complete element definition may include more than just the cells.

Each element shape may have a different number of nodes, depending on whether linear, quadratic, or cubic interpolation is used. Therefore the name of each type of element is composed of two parts; the first part identifies the element shape, and the second part the number of nodes. [Table 1](#) summarizes the element types supported in CGNS.

Table 1: Element Types in CGNS

Dimensionality of the Element	Shape	Linear Interpolation	Quadratic Interpolation	Cubic Interpolation	Quartic Interpolation
0-D	Point	NODE	NODE	NODE	NODE
1-D	Line	BAR_2	BAR_3	BAR_4	BAR_5
2-D	Triangle	TRI_3	TRI_6	TRI_9, TRI_10	TRI_12, TRI_15
	Quadrangle	QUAD_4	QUAD_8, QUAD_9	QUAD_12, QUAD_16	QUAD_P4_16, QUAD_25
3-D	Tetrahedron	TETRA_4	TETRA_10	TETRA_16, TETRA_20	TETRA_22, TETRA_34, TETRA_35
	Pyramid	PYRA_5	PYRA_13, PYRA_14	PYRA_21, PYRA_29, PYRA_30	PYRA_P4_29, PYRA_50, PYRA_55
	Pentahedron	PENTA_6	PENTA_15, PENTA_18	PENTA_24, PENTA_38, PENTA_40	PENTA_33, PENTA_66, PENTA_75
	Hexahedron	HEXA_8	HEXA_20, HEXA_27	HEXA_32, HEXA_56, HEXA_64	HEXA_44, HEXA_98, HEXA_125

General polyhedral elements can be recorded using the CGNS generic element types NGON_n and NFACE_n. See [Section 7.3](#) for more detail.

The ordering of the nodes within an element is important. Since the nodes in each element type could be ordered in multiple ways, it is necessary to define numbering conventions. The following sections describe the element numbering conventions used in CGNS.

Like a structured zone, an unstructured zone may contain grid-coordinates or flow-solution data at points outside of the zone itself, through the use of ghost or “rind” points and elements. However,

unlike for structured zones, rind data for unstructured zones cannot be defined implicitly (i.e., via indexing conventions alone). In other words, when using rind with unstructured zones, the rind grid points and their element connectivity information should always be given.

3.3.1 1-D (Line) Elements

1-D elements represent geometrically a line (or bar). The linear form, BAR_2, is composed of two nodes at each extremity of the line. The quadratic form, BAR_3, has an additional node located at the middle of the line. The cubic form of the line, BAR_4, contains two nodes interior to the endpoints. The quartic form of the line, BAR_5, contains three nodes interior to the endpoints.

Linear and Quadratic Elements:

BAR_2



BAR_3



Edge Definition

<u>Oriented edge</u>	<u>Corner nodes</u>	<u>Mid-node</u>
E1	N1,N2	N3

Cubic Elements:

BAR_4



Edge Definition

<u>Oriented edge</u>	<u>Corner nodes</u>	<u>Mid-nodes</u>
E1	N1,N2	N3,N4

Quartic Elements:

BAR_5



Edge Definition

Oriented edge	Corner nodes	Mid-nodes
E1	N1, N2	N3, N4, N5

Note that nodes are uniformly spaced on all edges for all higher order elements.

3.3.2 2-D (Surface) Elements

2-D elements represent a surface in either 2-D or 3-D space. Note that in physical space, the surface need not be planar, but may be curved. In a 2-D mesh the elements represent the cells themselves; in a 3-D mesh they represent faces. CGNS supports two shapes of 2-D elements — triangles and quadrangles.

The normal vector of a 2-D element is computed using the cross product of a vector from the first to second node, with a vector from the first to third node. The direction of the normal is such that the three vectors (i.e., $(\vec{N}_2 - \vec{N}_1)$, $(\vec{N}_3 - \vec{N}_1)$, and \vec{N}) form a right-handed triad.

$$\vec{N} = (\vec{N}_2 - \vec{N}_1) \times (\vec{N}_3 - \vec{N}_1)$$

In a 2-D mesh, all elements must be oriented the same way; i.e., all normals must point toward the same side of the mesh.

3.3.2.1 Triangular Elements

Six types of triangular elements are supported in CGNS, TRI_3, TRI_6, TRI_9, TRI_10, TRI_12, and TRI_15. TRI_3 elements are composed of three nodes located at the three geometric corners of the triangle. TRI_6 elements have three additional nodes located at the middles of the three edges. The cubic forms of triangular elements, TRI_9 and TRI_10 contain two interior nodes along each edge, and an interior face node in the case of TRI_10. The quartic forms of triangular elements, TRI_12 and TRI_15 contain three interior nodes along each edge, and three interior face nodes in the case of TRI_15.

Linear and Quadratic Elements:

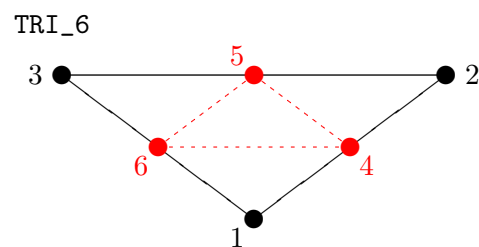
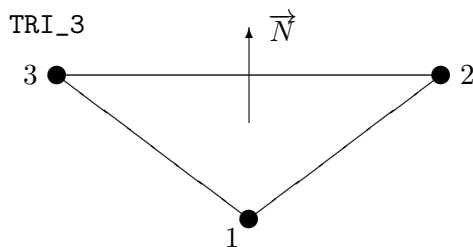

Edge Definition

Oriented edges	Corner nodes	Mid-node
E1	N1, N2	N4
E2	N2, N3	N5
E3	N3, N1	N6

Face Definition

Face	Corner nodes	Mid-edge nodes	Oriented edges
F1	N1, N2, N3	N4, N5, N6	E1, E2, E3

Cubic Elements:

TRL9

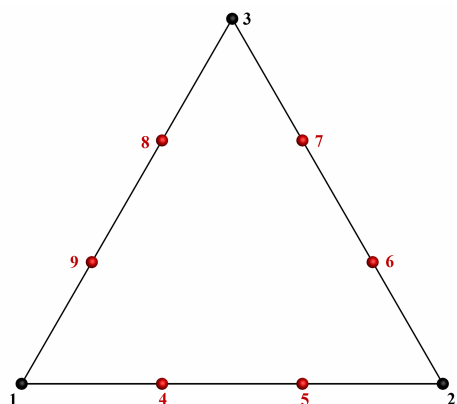

TRL10

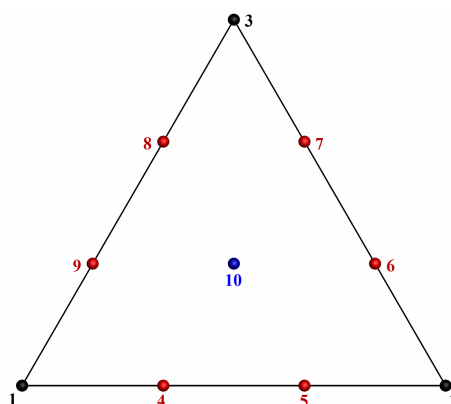

Edge Definition

<u>Oriented edges</u>	<u>Corner nodes</u>	<u>Mid-node</u>
E1	N1,N2	N4,N5
E2	N2,N3	N6,N7
E3	N3,N1	N8,N9

Face Definition

<u>Face</u>	<u>Corner nodes</u>	<u>Mid-edge nodes</u>	<u>Mid-face node</u>	<u>Oriented edges</u>
F1	N1,N2,N3	N4,N5,N6,N7,N8,N9	N10	E1,E2,E3

Notes

N1, . . . ,N10 Grid point identification number. Integer ≥ 0 or blank, and no two values may be the same. Grid points N1, N2, and N3 are in consecutive order about the triangle.

E1,E2,E3 Edge identification number.

F1 Face identification number.

Quartic Elements:

TRL12

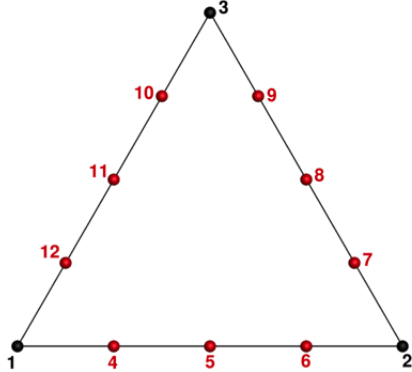

TRL15

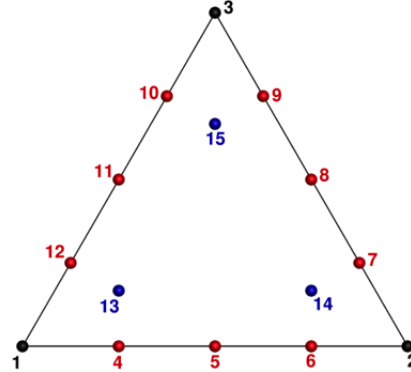
Edge Definition

Oriented edges	Corner nodes	Mid-node
E1	N1,N2	N4,N5,N6
E2	N2,N3	N7,N8,N9
E3	N3,N1	N10,N11,N12

Face Definition

Face	Corner nodes	Mid-edge nodes	Mid-face node	Oriented edges
F1	N1,N2,N3	N4,N5,N6,N7,N8, N9,N10,N11,N12	N13,N14,N15	E1,E2,E3

Notes

- N13 Is located at the centroid of sub-triangle N1-N5-N11.
- N14 Is located at the centroid of sub-triangle N2-N8-N5.
- N15 Is located at the centroid of sub-triangle N3-N11-N8.

3.3.2.2 Quadrilateral Elements

CGNS supports seven types of quadrilateral elements, QUAD_4, QUAD_8, QUAD_9, QUAD_12, QUAD_16, QUAD_P4_16, and QUAD_25. QUAD_4 elements are composed of four nodes located at the four geometric corners of the quadrangle. In addition, QUAD_8 and QUAD_9 elements have four mid-edge nodes, and QUAD_9 adds a mid-face node. The cubic forms of quadrilateral elements, QUAD_12 and QUAD_16 contain two interior nodes along each edge, and four interior face nodes in the case of QUAD_16. The quartic forms of quadrilateral elements, QUAD_P4_16 and QUAD_25 contain three interior nodes along each edge, and nine interior face nodes in the case of QUAD_25.

Linear and Quadratic Elements:

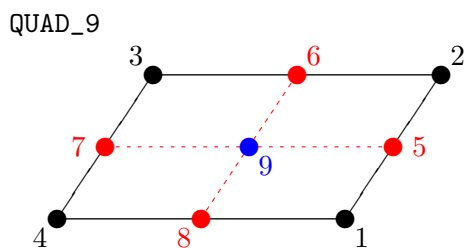
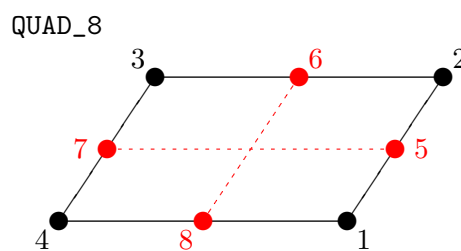
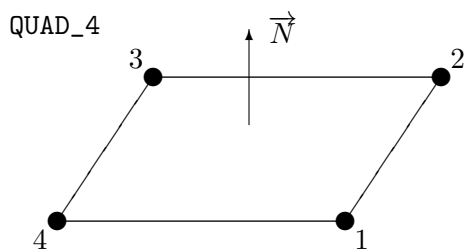

Edge Definition

Oriented edges	Corner nodes	Mid-node
E1	N1, N2	N5
E2	N2, N3	N6
E3	N3, N4	N7
E4	N4, N1	N8

Face Definition

Face	Corner nodes	Mid-edge nodes	Mid-face node	Oriented edges
F1	N1, N2, N3, N4	N5, N6, N7, N8	N9	E1, E2, E3, E4

Cubic Elements:

QUAD_12

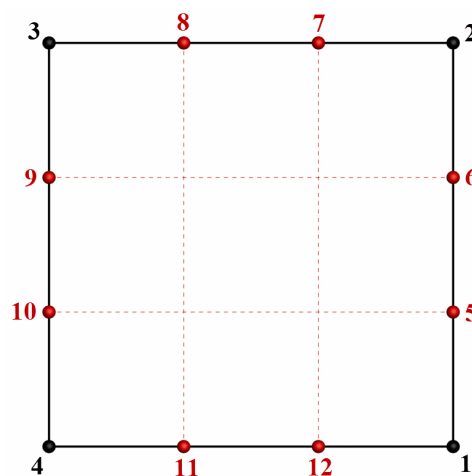

QUAD_16

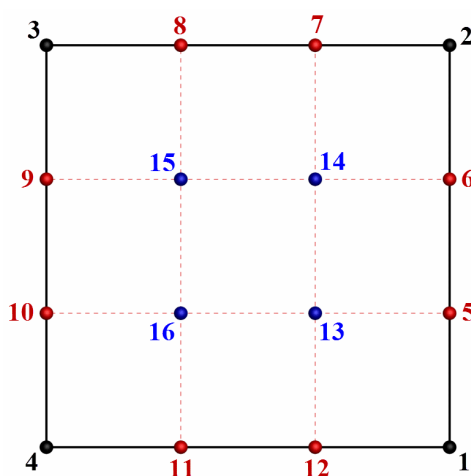
Edge Definition

<u>Oriented edges</u>	<u>Corner nodes</u>	<u>Mid-node</u>
E1	N1, N2	N5, N6
E2	N2, N3	N7, N8
E3	N3, N4	N9, N10
E4	N4, N1	N11, N12

Face Definition

<u>Face</u>	<u>Corner nodes</u>	<u>Mid-edge nodes</u>	<u>Mid-face node</u>	<u>Oriented edges</u>
F1	N1, N2, N3, N4	N5, N6, N7, N8, N9, N10, N11, N12	N13, N14, N15, N16	E1, E2, E3, E4

Notes

- N1, ..., N16 Grid point identification number. Integer ≥ 0 or blank, and no two values may be the same. Grid points N1...N4 are in consecutive order about the quadrangle.
- E1, ..., E4 Edge identification number.
- F1 Face identification number.

Quartic Elements:

QUAD_P4_16

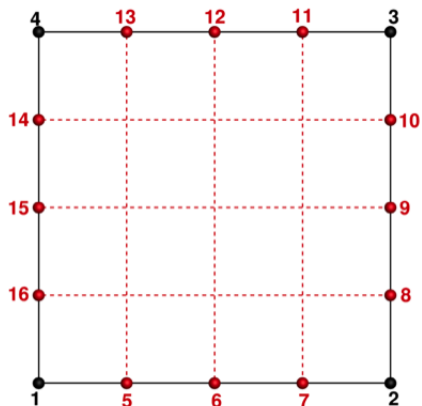

QUAD_25

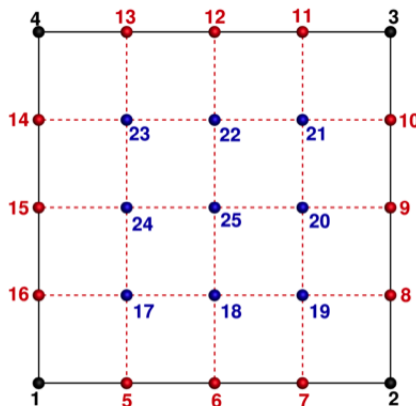

Edge Definition

<u>Oriented edges</u>	<u>Corner nodes</u>	<u>Mid-node</u>
E1	N1,N2	N5,N6,N7
E2	N2,N3	N8,N9,N10
E3	N3,N4	N11,N12,N13
E4	N4,N1	N14,N15,N16

Face Definition

<u>Face</u>	<u>Corner nodes</u>	<u>Mid-edge nodes</u>	<u>Mid-face node</u>	<u>Oriented edges</u>
F1	N1,N2,N3,N4	N5,N6,N7,N8,N9,N10,N11,N12,N13,N14,N15,N16	N17,N18,N19,N20,N21,N22,N23,N24,N25	E1,E2,E3,E4

3.3.3 3-D (Volume) Elements

3-D elements represent a volume in 3-D space, and constitute the cells of a 3-D mesh. CGNS supports four different shapes of 3-D elements — tetrahedra, pyramids, pentahedra, and hexahedra.

3.3.3.1 Tetrahedral Elements

CGNS supports seven types of tetrahedral elements, TETRA_4, TETRA_10, TETRA_16, TETRA_20, TETRA_22, TETRA_34, and TETRA_35. TETRA_4 elements are composed of four nodes located at the four geometric corners of the tetrahedron. TETRA_10 elements have six additional nodes, at the middle of each of the six edges. The cubic forms of tetrahedral elements, TETRA_16 and TETRA_20 contain two interior nodes along each edge, and four interior face nodes in the case of TETRA_20. The quartic forms of tetrahedral elements, TETRA_22, TETRA_34, and TETRA_35 contain three interior

nodes along each edge, twelve interior face nodes in the case of TETRA_34, and twelve interior face nodes plus one interior volume node in the case of TETRA_35.

Linear and Quadratic Elements:

TETRA_4

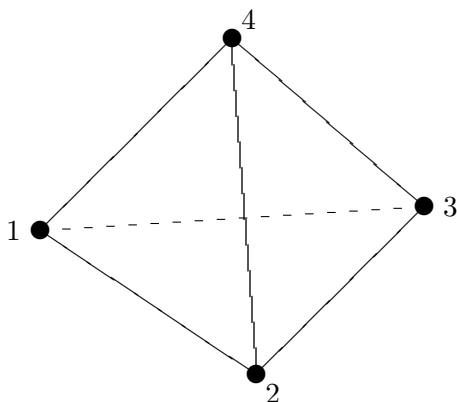

TETRA_10

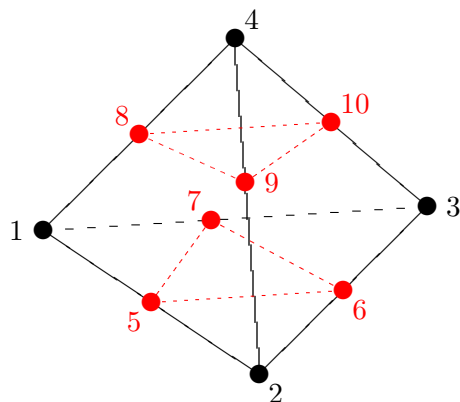

Edge Definition

<u>Oriented edges</u>	<u>Corner nodes</u>	<u>Mid-node</u>
E1	N1, N2	N5
E2	N2, N3	N6
E3	N3, N1	N7
E4	N1, N4	N8
E5	N2, N4	N9
E6	N3, N4	N10

Face Definition

<u>Face</u>	<u>Corner nodes</u>	<u>Mid-edge nodes</u>	<u>Oriented edges</u>
F1	N1, N3, N2	N7, N6, N5	-E3, -E2, -E1
F2	N1, N2, N4	N5, N9, N8	E1, E5, -E4
F3	N2, N3, N4	N6, N10, N9	E2, E6, -E5
F4	N3, N1, N4	N7, N8, N10	E3, E4, -E6

Cubic Elements:

TETRA_16

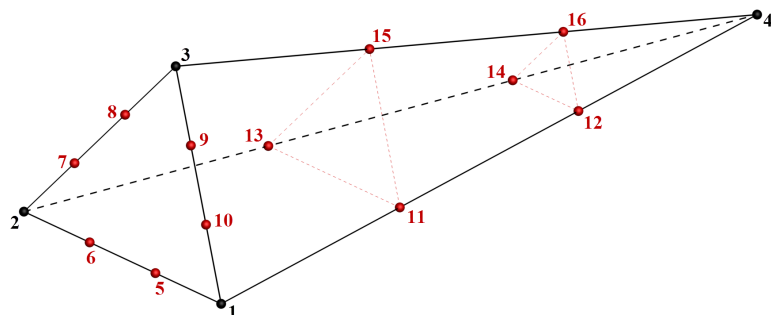

TETRA_20

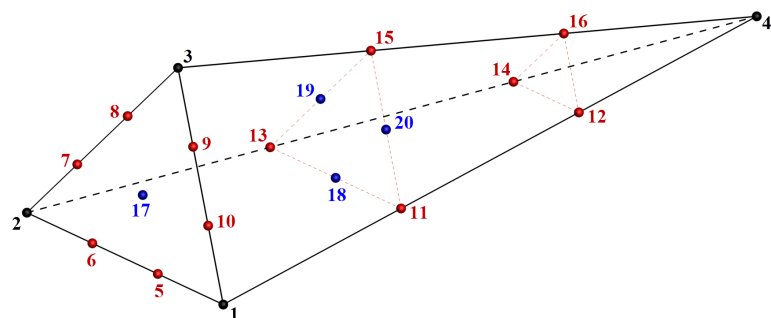

Edge Definition

<u>Oriented edges</u>	<u>Corner nodes</u>	<u>Mid-node</u>
E1	N1, N2	N5, N6
E2	N2, N3	N7, N8
E3	N3, N1	N9, N10
E4	N1, N4	N11, N12
E5	N2, N4	N13, N14
E6	N3, N4	N15, N16

Face Definition

<u>Face</u>	<u>Corner nodes</u>	<u>Mid-edge nodes</u>	<u>Mid-face node</u>	<u>Oriented edges</u>
F1	N1, N3, N2	N10, N9, N8, N7, N6, N5	N17	-E3, -E2, -E1
F2	N1, N2, N4	N5, N6, N13, N14, N12, N11	N18	E1, E5, -E4
F3	N2, N3, N4	N7, N8, N15, N16, N14, N13	N19	E2, E6, -E5
F4	N3, N1, N4	N9, N10, N11, N12, N16, N15	N20	E3, E4, -E6

Notes

- N1, . . . ,N20** Grid point identification number. Integer ≥ 0 or blank, and no two values may be the same. Grid points **N1..N3** are in consecutive order about one trilateral face. The cross product of a vector going from **N1** to **N2**, with a vector going from **N1** to **N3**, must result in a vector oriented from face **F1** toward **N4**.
- E1, . . . ,E6** Edge identification number. The edges are oriented from the first to the second node. A negative edge (e.g., **-E1**) means that the edge is used in its reverse direction.
- F1, . . . ,F4** Face identification number. The faces are oriented so that the cross product of a vector from its first to second node, with a vector from its first to third node, is oriented outward.

Quartic Elements:

TETRA_22

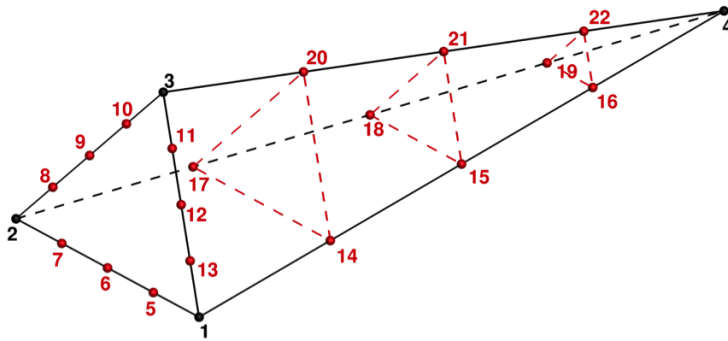

TETRA_34

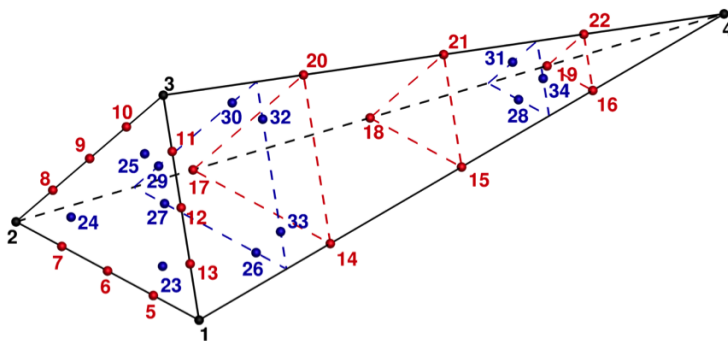

TETRA_35

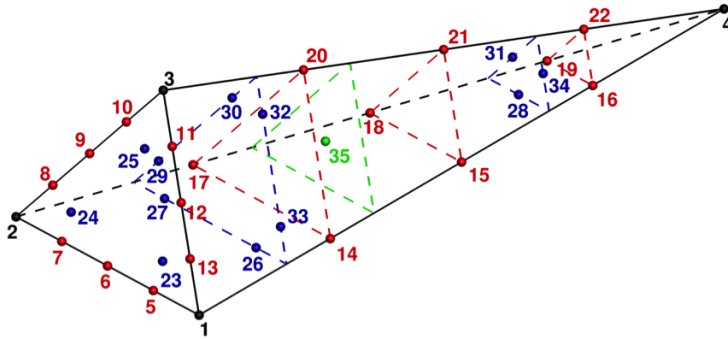
Edge Definition

Oriented edges	Corner nodes	Mid-node
E1	N1, N2	N5, N6, N7
E2	N2, N3	N8, N9, N10
E3	N3, N1	N11, N12, N13
E4	N1, N4	N14, N15, N16
E5	N2, N4	N17, N18, N19
E6	N3, N4	N20, N21, N22

Face Definition

Face	Corner nodes	Mid-edge nodes	Mid-face node	Oriented edges
F1	N1, N3, N2	N13, N12, N11, N10, N9, N8, N7, N6, N5	N23, N24, N25	-E3, -E2, -E1
F2	N1, N2, N4	N5, N6, N7, N17, N18, N19, N16, N15, N14	N26, N27, N28	E1, E5, -E4
F3	N2, N3, N4	N8, N9, N10, N20, N21, N22, N19, N18, N17	N29, N30, N31	E2, E6, -E5
F4	N3, N1, N4	N11, N12, N13, N14, N15, N16, N22, N21, N20	N32, N33, N34	E3, E4, -E6

Notes

- N23 Is located at the centroid of sub-triangle N1-N12-N6.
- N24 Is located at the centroid of sub-triangle N2-N6-N9.
- N25 Is located at the centroid of sub-triangle N3-N9-N12.
- N26 Is located at the centroid of sub-triangle N1-N6-N15.
- N27 Is located at the centroid of sub-triangle N2-N18-N6.

N28	Is located at the centroid of sub-triangle N4-N15-N18.
N29	Is located at the centroid of sub-triangle N2-N9-N18.
N30	Is located at the centroid of sub-triangle N3-N21-N9.
N31	Is located at the centroid of sub-triangle N4-N18-N21.
N32	Is located at the centroid of sub-triangle N3-N12-N21.
N33	Is located at the centroid of sub-triangle N1-N15-N12.
N34	Is located at the centroid of sub-triangle N4-N21-N15.
N35	Is located at the centroid of the tetrahedron.

3.3.3.2 Pyramid Elements

CGNS supports nine types of pyramid elements, PYRA_5, PYRA_13, PYRA_14, PYRA_21, PYRA_29, PYRA_30, PYRA_P4_29, PYRA_50, and PYRA_55. PYRA_5 elements are composed of five nodes located at the five geometric corners of the pyramid. In addition, PYRA_13 and PYRA_14 elements have a node at the middle of each of the eight edges; PYRA_14 adds a node at the middle of the quadrilateral face. The cubic forms of pyramid elements, PYRA_21, PYRA_29, and PYRA_30 contain two interior nodes along each edge, eight interior face nodes in the case of PYRA_29 and PYRA_30, and an additional interior volume node for PYRA_30. The quartic forms of pyramid elements, PYRA_P4_29, PYRA_50, and PYRA_55 contain three interior nodes along each edge, 21 interior face nodes in the case of PYRA_50, and 21 interior face nodes and five additional interior volume nodes for PYRA_55.

Linear and Quadratic Elements:

PYRA_5

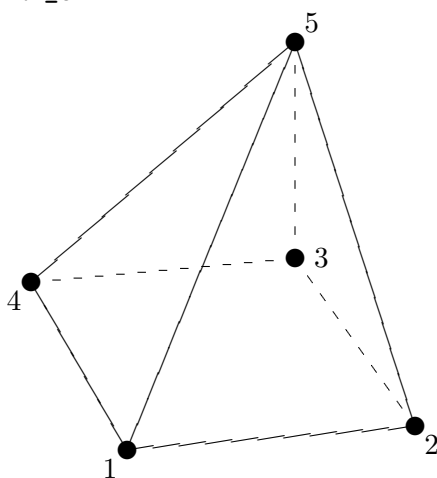

PYRA_13

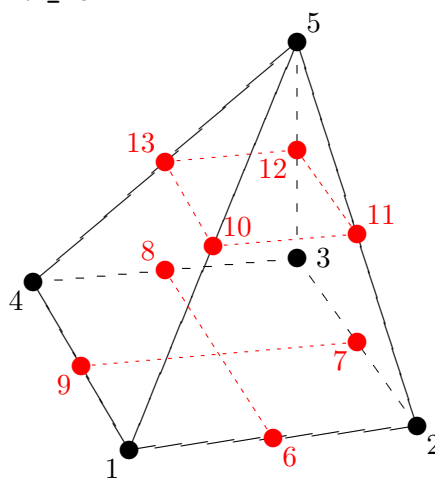

PYRA_14

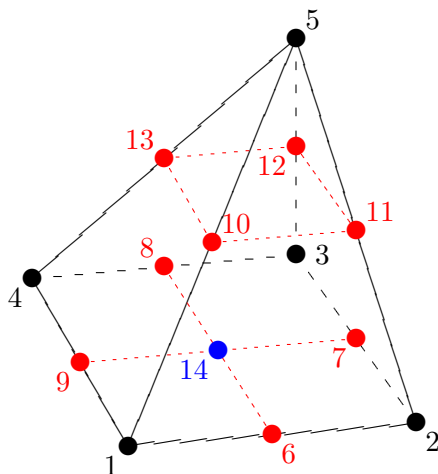
Edge Definition

<u>Oriented edges</u>	<u>Corner nodes</u>	<u>Mid-node</u>
E1	N1, N2	N6
E2	N2, N3	N7
E3	N3, N4	N8
E4	N4, N1	N9
E5	N1, N5	N10
E6	N2, N5	N11
E7	N3, N5	N12
E8	N4, N5	N13

Face Definition

<u>Face</u>	<u>Corner nodes</u>	<u>Mid-edge nodes</u>	<u>Mid-face node</u>	<u>Oriented edges</u>
F1	N1, N4, N3, N2	N9, N8, N7, N6	N14	-E4, -E3, -E2, -E1
F2	N1, N2, N5	N6, N11, N10		E1, E6, -E5
F3	N2, N3, N5	N7, N12, N11		E2, E7, -E6
F4	N3, N4, N5	N8, N13, N12		E3, E8, -E7
F5	N4, N1, N5	N9, N10, N13		E4, E5, -E8

Cubic Elements:

PYRA_21

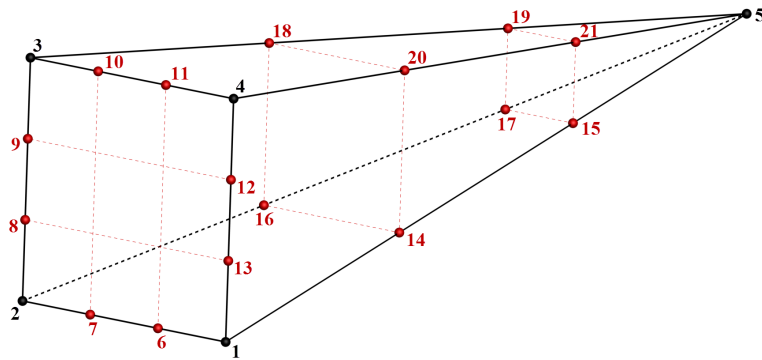

PYRA_29

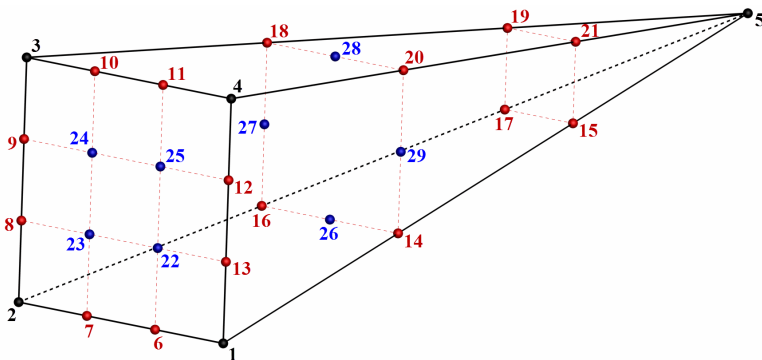

PYRA_30

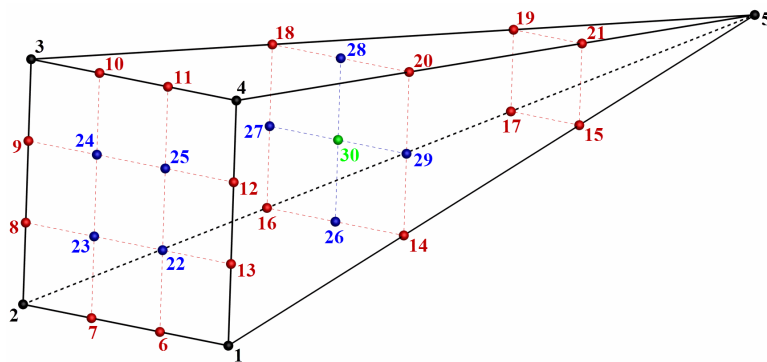
Edge Definition

<u>Oriented edges</u>	<u>Corner nodes</u>	<u>Mid-node</u>
E1	N1, N2	N6, N7
E2	N2, N3	N8, N9
E3	N3, N4	N10, N11
E4	N4, N1	N12, N13
E5	N1, N5	N14, N15
E6	N2, N5	N16, N17
E7	N3, N5	N18, N19
E8	N4, N5	N20, N21

Face Definition

<u>Face</u>	<u>Corner nodes</u>	<u>Mid-edge nodes</u>	<u>Mid-face node</u>	<u>Oriented edges</u>
F1	N1, N4, N3, N2	N13, N12, N11, N10, N9, N8, N7, N6	N22, N25, N24, N23	-E4, -E3, -E2, -E1
F2	N1, N2, N5	N6, N7, N16, N17, N15, N14	N26	E1, E6, -E5
F3	N2, N3, N5	N8, N9, N18, N19, N17, N16	N27	E2, E7, -E6
F4	N3, N4, N5	N10, N11, N20, N21, N19, N18	N28	E3, E8, -E7
F5	N4, N1, N5	N12, N13, N14, N15, N21, N20	N29	E4, E5, -E8

Notes

- N1, . . . , N30 Grid point identification number. Integer ≥ 0 or blank, and no two values may be the same. Grid points N1. . . N4 are in consecutive order about the quadrilateral face. The cross product of a vector going from N1 to N2, with a vector going from N1 to N3, must result in a vector oriented from face F1 toward N5.
- E1, . . . , E8 Edge identification number. The edges are oriented from the first to the second node. A negative edge (e.g., -E1) means that the edge is used in its reverse direction.

F1, . . . , F5 Face identification number. The faces are oriented so that the cross product of a vector from its first to second node, with a vector from its first to third node, is oriented outward.

Quartic Elements:

PYRA_P4_29

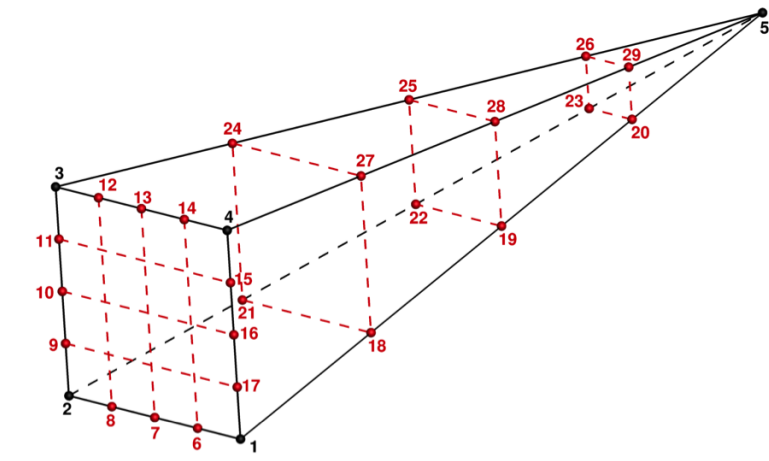

PYRA_50

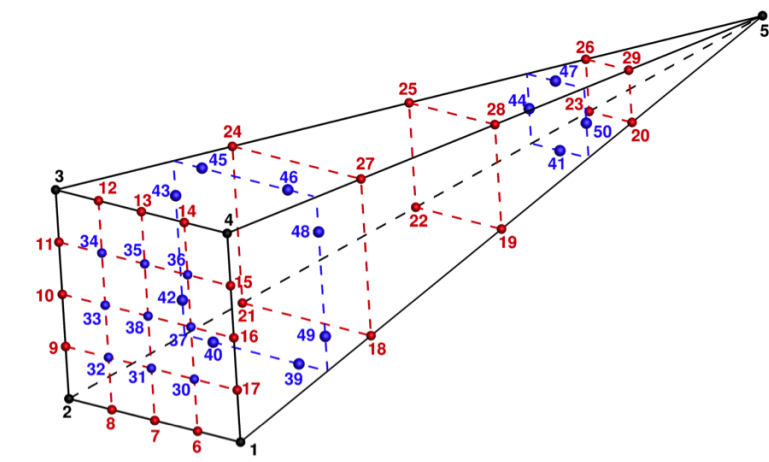

PYRA_55

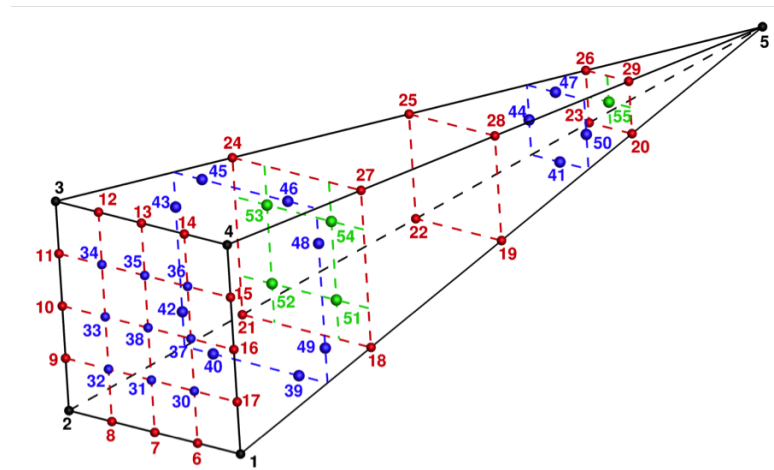

Edge Definition

<u>Oriented edges</u>	<u>Corner nodes</u>	<u>Mid-node</u>
E1	N1,N2	N6,N7,N8
E2	N2,N3	N9,N10,N11
E3	N3,N4	N12,N13,N14
E4	N4,N1	N15,N16,N17
E5	N1,N5	N18,N19,N20
E6	N2,N5	N21,N22,N23
E7	N3,N5	N24,N25,N26
E8	N4,N5	N27,N28,N29

Face Definition

<u>Face</u>	<u>Corner nodes</u>	<u>Mid-edge nodes</u>	<u>Mid-face node</u>	<u>Oriented edges</u>
F1	N1,N4,N3,N2	N17,N16,N15,N14,N13,N12, N11,N10,N9,N8,N7,N6	N30,N31,N32,N33,N34, N35,N36,N37,N38	-E4,-E3,-E2,-E1
F2	N1,N2,N5	N6,N7,N8,N21,N22,N23, N20,N19,N18	N39,N40,N41	E1, E6,-E5
F3	N2,N3,N5	N9,N10,N11,N24,N25,N26, N23,N22,N21	N42,N43,N44	E2, E7,-E6
F4	N3,N4,N5	N12,N13,N14,N27,N28,N29, N26,N25,N24	N45,N46,N47	E3, E8,-E7
F5	N4,N1,N5	N15,N16,N17,N18,N19,N20, N29,N28,N27	N48,N49,N50	E4, E5,-E8

Notes

N39 Is located at the centroid of sub-triangle N1-N7-N19.

N40	Is located at the centroid of sub-triangle N2-N22-N7.
N41	Is located at the centroid of sub-triangle N5-N19-N22.
N42	Is located at the centroid of sub-triangle N2-N10-N22.
N43	Is located at the centroid of sub-triangle N3-N25-N10.
N44	Is located at the centroid of sub-triangle N5-N22-N25.
N45	Is located at the centroid of sub-triangle N3-N13-N25.
N46	Is located at the centroid of sub-triangle N4-N28-N13.
N47	Is located at the centroid of sub-triangle N5-N25-N28.
N48	Is located at the centroid of sub-triangle N4-N16-N28.
N49	Is located at the centroid of sub-triangle N1-N19-N16.
N50	Is located at the centroid of sub-triangle N5-N28-N19.
N51	Is located at the intersection of the line N5-N30 and the face N18-N21-N24-N27.
N52	Is located at the intersection of the line N5-N32 and the face N18-N21-N24-N27.
N53	Is located at the intersection of the line N5-N34 and the face N18-N21-N24-N27.
N54	Is located at the intersection of the line N5-N36 and the face N18-N21-N24-N27.
N55	Is located at the intersection of the line N5-N38 and the face N20-N23-N26-N29.

3.3.3.3 Pentahedral Elements

CGNS supports nine types of pentahedral elements, PENTA_6, PENTA_15, PENTA_18, PENTA_24, PENTA_38, PENTA_40, PENTA_33, PENTA_66, and PENTA_75. PENTA_6 elements are composed of six nodes located at the six geometric corners of the pentahedron. In addition, PENTA_15 and PENTA_18 elements have a node at the middle of each of the nine edges; PENTA_18 adds a node at the middle of each of the three quadrilateral faces. The cubic forms of the pentahedral elements, PENTA_24, PENTA_38, and PENTA_40 contain two interior nodes along each edge, fourteen interior face nodes in the case of PENTA_38 and PENTA_40, and an additional two interior volume nodes for PENTA_40. The quartic forms of the pentahedral elements, PENTA_33, PENTA_66, and PENTA_75 contain three interior nodes along each edge, 33 interior face nodes in the case of PENTA_66, and 33 interior face nodes and an additional nine interior volume nodes for PENTA_75.

Linear and Quadratic Elements:

PENTA_6

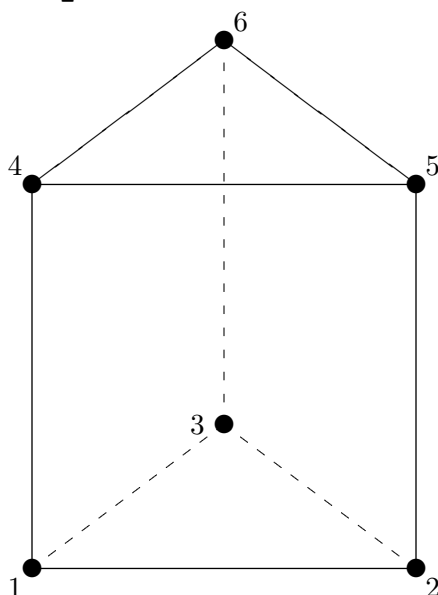

PENTA_15

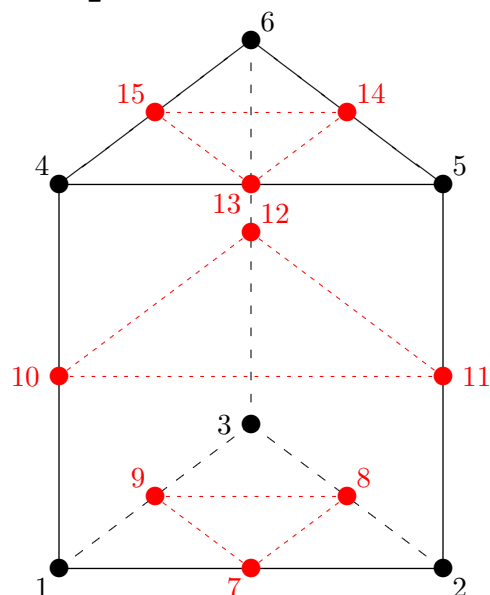

PENTA_18

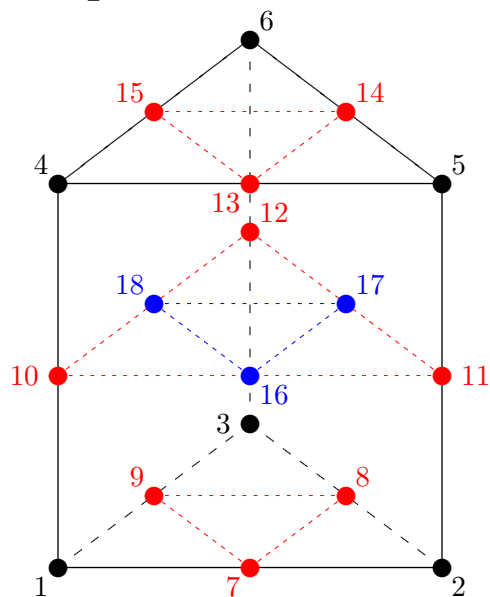

Edge Definition

<u>Oriented edges</u>	<u>Corner nodes</u>	<u>Mid-node</u>
E1	N1, N2	N7
E2	N2, N3	N8
E3	N3, N1	N9
E4	N1, N4	N10
E5	N2, N5	N11
E6	N3, N6	N12
E7	N4, N5	N13
E8	N5, N6	N14
E9	N6, N4	N15

Face Definition

<u>Face</u>	<u>Corner nodes</u>	<u>Mid-edge nodes</u>	<u>Mid-face node</u>	<u>Oriented edges</u>
F1	N1, N2, N5, N4	N7, N11, N13, N10	N16	E1, E5, -E7, -E4
F2	N2, N3, N6, N5	N8, N12, N14, N11	N17	E2, E6, -E8, -E5
F3	N3, N1, N4, N6	N9, N10, N15, N12	N18	E3, E4, -E9, -E6
F4	N1, N3, N2	N9, N8, N7		-E3, -E2, -E1
F5	N4, N5, N6	N13, N14, N15		E7, E8, E9

Cubic Elements:

PENTA_24

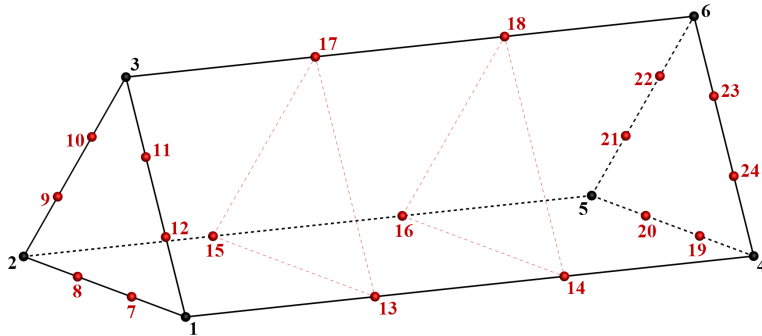

PENTA_38

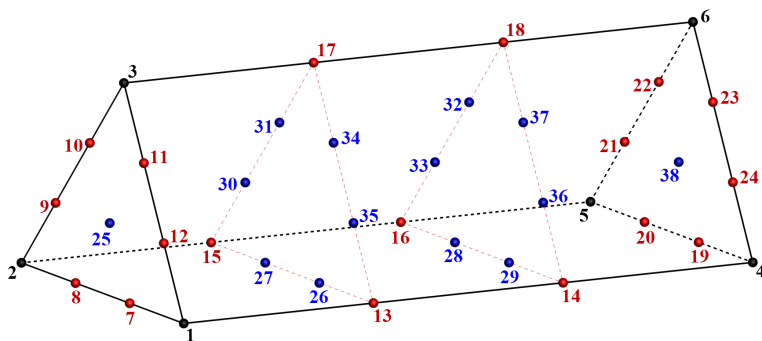

PENTA_40

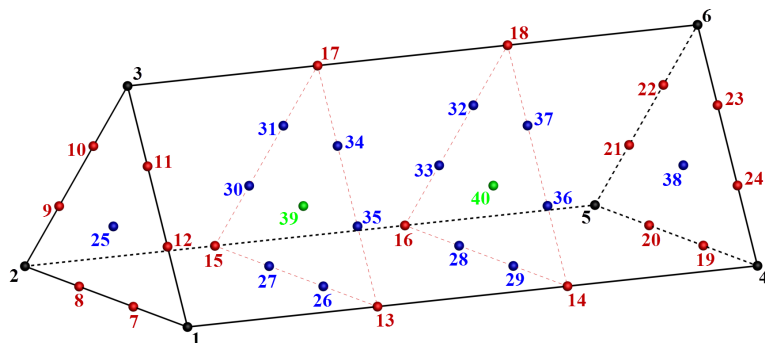

Edge Definition

<u>Oriented edges</u>	<u>Corner nodes</u>	<u>Mid-node</u>
E1	N1, N2	N7, N8
E2	N2, N3	N9, N10
E3	N3, N1	N11, N12
E4	N1, N4	N13, N14
E5	N2, N5	N15, N16
E6	N3, N6	N17, N18
E7	N4, N5	N19, N20
E8	N5, N6	N21, N22
E9	N6, N4	N23, N24

Face Definition

<u>Face</u>	<u>Corner nodes</u>	<u>Mid-edge nodes</u>	<u>Mid-face node</u>	<u>Oriented edges</u>
F1	N1, N2, N5, N4	N7, N8, N15, N16, N20, N19, N14, N13	N26, N27, N28, N29	E1, E5, -E7, -E4
F2	N2, N3, N6, N5	N9, N10, N17, N18, N22, N21, N16, N15	N30, N31, N32, N33	E2, E6, -E8, -E5
F3	N3, N1, N4, N6	N11, N12, N13, N14, N24, N23, N18, N17	N34, N35, N36, N37	E3, E4, -E9, -E6
F4	N1, N3, N2	N12, N11, N10, N9, N8, N7	N25	-E3, -E2, -E1
F5	N4, N5, N6	N19, N20, N21, N22, N23, N24	N38	E7, E8, E9

Notes

- N1, ..., N40 Grid point identification number. Integer ≥ 0 or blank, and no two values may be the same. Grid points N1...N3 are in consecutive order about one trilateral face. Grid points N4...N6 are in order in the same direction around the opposite trilateral face.
- E1, ..., E9 Edge identification number. The edges are oriented from the first to the second node. A negative edge (e.g., -E1) means that the edge is used in its reverse direction.

- F1, . . . ,F5 Face identification number. The faces are oriented so that the cross product of a vector from its first to second node, with a vector from its first to third node, is oriented outward.
- N39 Is at the centroid of the triangle N13,N17,N15.
- N40 Is at the centroid of the triangle N14,N18,N16.

Quartic Elements:

PENTA_33

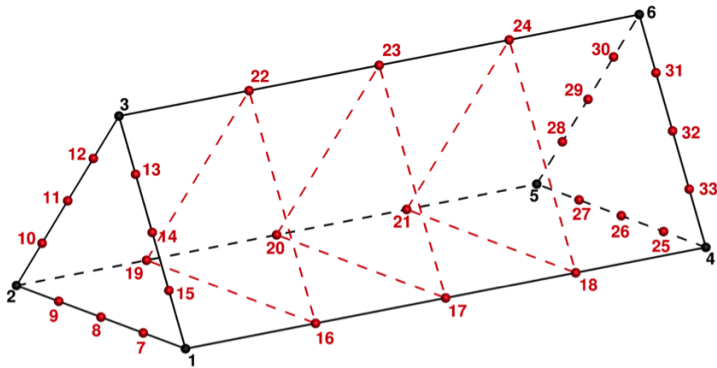

PENTA_66

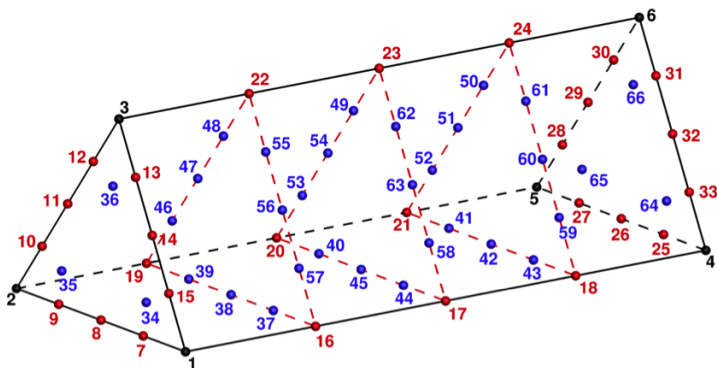

PENTA_75

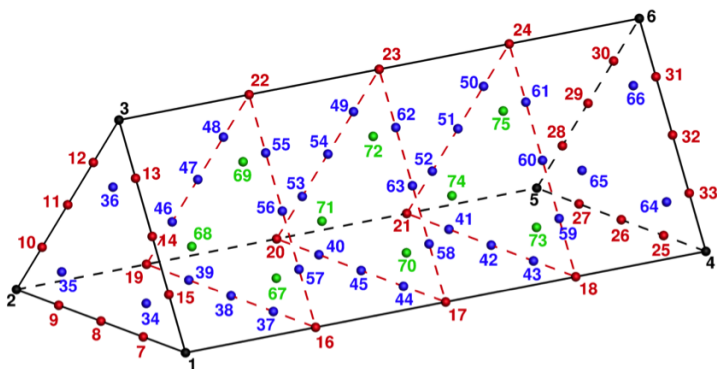
Edge Definition

<u>Oriented edges</u>	<u>Corner nodes</u>	<u>Mid-node</u>
E1	N1, N2	N7, N8, N9
E2	N2, N3	N10, N11, N12
E3	N3, N1	N13, N14, N15
E4	N1, N4	N16, N17, N18
E5	N2, N5	N19, N20, N21
E6	N3, N6	N22, N23, N24
E7	N4, N5	N25, N26, N27
E8	N5, N6	N28, N29, N30
E9	N6, N4	N31, N32, N33

Face Definition

<u>Face</u>	<u>Corner nodes</u>	<u>Mid-edge nodes</u>	<u>Mid-face node</u>	<u>Oriented edges</u>
F1	N1, N2, N5, N4	N7, N8, N9, N19, N20, N21, N27, N26, N25, N18, N17, N16	N37, N38, N39, N40, N41, N42, N43, N44, N45	E1, E5, -E7, -E4
F2	N2, N3, N6, N5	N10, N11, N12, N22, N23, N24, N30, N29, N28, N21, N20, N19	N46, N47, N48, N49, N50, N51, N52, N53, N54	E2, E6, -E8, -E5
F3	N3, N1, N4, N6	N13, N14, N15, N16, N17, N18, N33, N32, N31, N24, N23, N22	N55, N56, N57, N58, N59, N60, N61, N62, N63	E3, E4, -E9, -E6
F4	N1, N3, N2	N15, N14, N13, N12, N11, N10, N9, N8, N7	N34, N35, N36	-E3, -E2, -E1
F5	N4, N5, N6	N25, N26, N27, N28, N29, N30, N31, N32, N33	N64, N65, N66	E7, E8, E9

Notes

N34	Is located at the centroid of sub-triangle N1-N14-N8.
N35	Is located at the centroid of sub-triangle N2-N8-N11.
N36	Is located at the centroid of sub-triangle N3-N11-N14.
N64	Is located at the centroid of sub-triangle N4-N26-N32.
N65	Is located at the centroid of sub-triangle N5-N29-N26.
N66	Is located at the centroid of sub-triangle N6-N32-N29.
N67	Is located at the centroid of sub-triangle N16-N38-N56.
N68	Is located at the centroid of sub-triangle N19-N47-N38.
N69	Is located at the centroid of sub-triangle N22-N56-N47.
N70	Is located at the centroid of sub-triangle N17-N45-N63.
N71	Is located at the centroid of sub-triangle N20-N54-N45.
N72	Is located at the centroid of sub-triangle N23-N63-N54.
N73	Is located at the centroid of sub-triangle N18-N42-N60.
N74	Is located at the centroid of sub-triangle N21-N51-N42.
N75	Is located at the centroid of sub-triangle N24-N60-N51.

3.3.3.4 Hexahedral Elements

CGNS supports nine types of hexahedral elements, `HEXA_8`, `HEXA_20`, `HEXA_27`, `HEXA_32`, `HEXA_56`, `HEXA_64`, `HEXA_44`, `HEXA_98`, and `HEXA_125`. `HEXA_8` elements are composed of eight nodes located at the eight geometric corners of the hexahedron. In addition, `HEXA_20` and `HEXA_27` elements have a node at the middle of each of the twelve edges; `HEXA_27` adds a node at the middle of each of the six faces, and one at the cell center. The cubic forms of the hexahedral elements, `HEXA_32`, `HEXA_56`, and `HEXA_64` contain two interior nodes along each edge, 24 interior face nodes in the case of `HEXA_56` and `HEXA_64`, and an additional eight interior volume nodes for `HEXA_64`. The quartic forms of the hexahedral elements, `HEXA_44`, `HEXA_98`, and `HEXA_125` contain three interior nodes along each edge, 54 interior face nodes in the case of `HEXA_98`, and 54 interior face nodes and an additional 27 interior volume nodes for `HEXA_125`.

Linear and Quadratic Elements:

HEXA_8

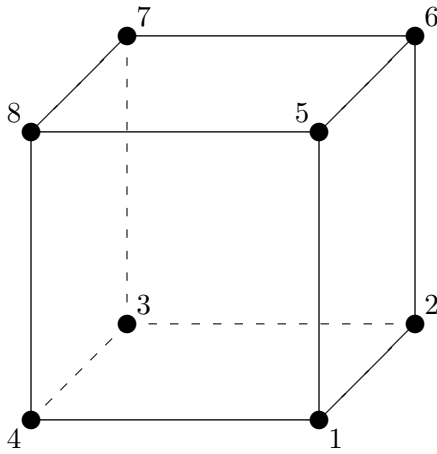

HEXA_20

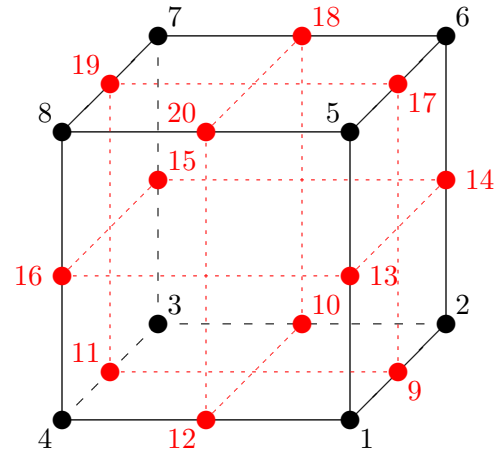

HEXA_27

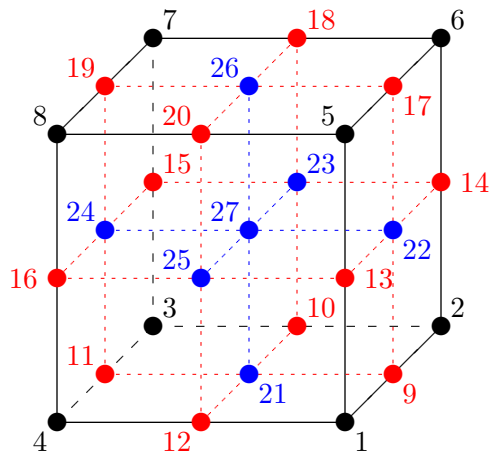

Edge Definition

<u>Oriented edges</u>	<u>Corner nodes</u>	<u>Mid-node</u>
E1	N1, N2	N9
E2	N2, N3	N10
E3	N3, N4	N11
E4	N4, N1	N12
E5	N1, N5	N13
E6	N2, N6	N14
E7	N3, N7	N15
E8	N4, N8	N16
E9	N5, N6	N17
E10	N6, N7	N18
E11	N7, N8	N19
E12	N8, N5	N20

Face Definition

<u>Face</u>	<u>Corner nodes</u>	<u>Mid-edge nodes</u>	<u>Mid-face node</u>	<u>Oriented edges</u>
F1	N1, N4, N3, N2	N12, N11, N10, N9	N21	-E4, -E3, -E2, -E1
F2	N1, N2, N6, N5	N9, N14, N17, N13	N22	E1, E6, -E9, -E5
F3	N2, N3, N7, N6	N10, N15, N18, N14	N23	E2, E7, -E10, -E6
F4	N3, N4, N8, N7	N11, N16, N19, N15	N24	E3, E8, -E11, -E7
F5	N1, N5, N8, N4	N13, N20, N16, N12	N25	E5, -E12, -E8, E4
F6	N5, N6, N7, N8	N17, N18, N19, N20	N26	E9, E10, E11, E12

Cubic Elements:

HEXA_32

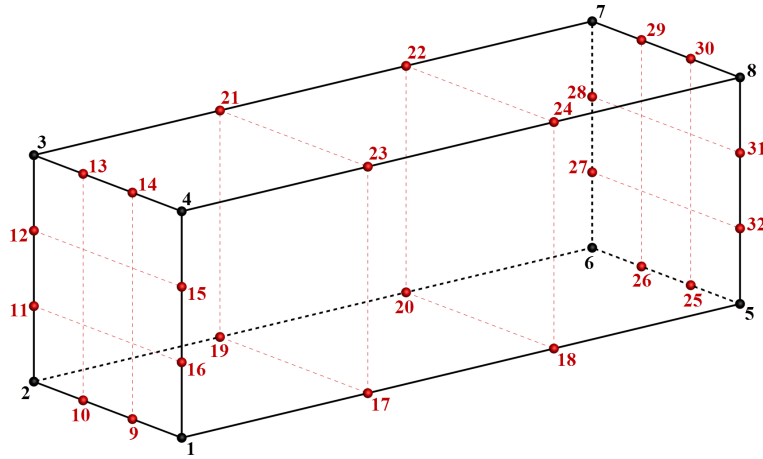

HEXA_56

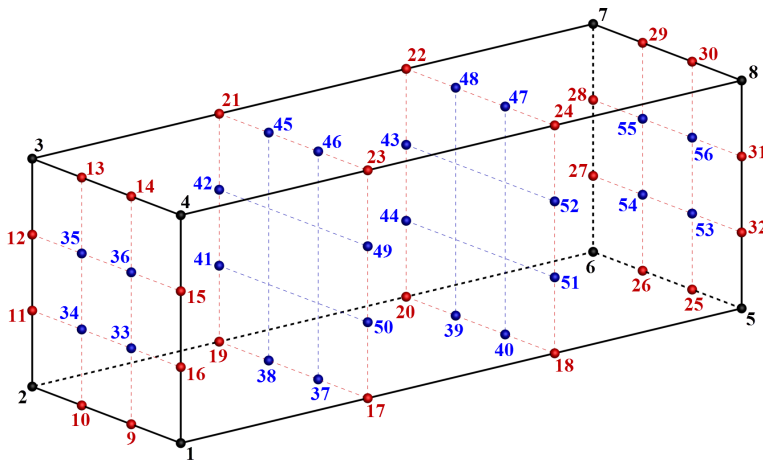

HEXA_64

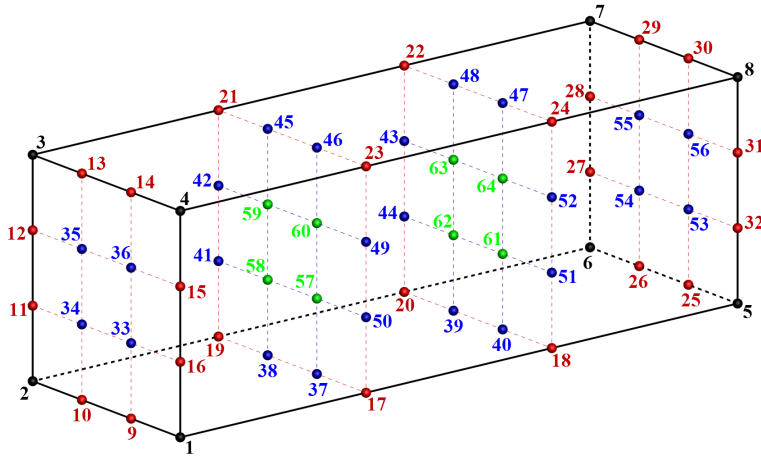
Edge Definition

<u>Oriented edges</u>	<u>Corner nodes</u>	<u>Mid-node</u>
E1	N1, N2	N9, N10
E2	N2, N3	N11, N12
E3	N3, N4	N13, N14
E4	N4, N1	N15, N16
E5	N1, N5	N17, N18
E6	N2, N6	N19, N20
E7	N3, N7	N21, N22
E8	N4, N8	N23, N24
E9	N5, N6	N25, N26
E10	N6, N7	N27, N28
E11	N7, N8	N29, N30
E12	N8, N5	N31, N32

Face Definition

<u>Face</u>	<u>Corner nodes</u>	<u>Mid-edge nodes</u>	<u>Mid-face node</u>	<u>Oriented edges</u>
F1	N1, N4, N3, N2	N16, N15, N14, N13, N12, N11, N10, N9	N33, N36, N35, N34	-E4, -E3, -E2, -E1
F2	N1, N2, N6, N5	N9, N10, N19, N20, N26, N25, N18, N17	N37, N38, N39, N40	E1, E6, -E9, -E5
F3	N2, N3, N7, N6	N11, N12, N21, N22, N28, N27, N20, N19	N41, N42, N43, N44	E2, E7, -E10, -E6
F4	N3, N4, N8, N7	N13, N14, N23, N24, N30, N29, N22, N21	N45, N46, N47, N48	E3, E8, -E11, -E7
F5	N1, N5, N8, N4	N17, N18, N32, N31, N24, N23, N15, N16	N49, N50, N51, N52	E5, -E12, -E8, E4
F6	N5, N6, N7, N8	N25, N26, N27, N28, N29, N30, N31, N32	N53, N54, N55, N56	E9, E10, E11, E12

Notes

N1, ..., N64 Grid point identification number. Integer ≥ 0 or blank, and no two values may be

the same. Grid points $N1 \dots N4$ are in consecutive order about one quadrilateral face. Grid points $N5 \dots N8$ are in order in the same direction around the opposite quadrilateral face.

- $E1, \dots, E12$ Edge identification number. The edges are oriented from the first to the second node. A negative edge (e.g., $-E1$) means that the edge is used in its reverse direction.
- $F1, \dots, F6$ Face identification number. The faces are oriented so that the cross product of a vector from its first to second node, with a vector from its first to third node, is oriented outward.

Quartic Elements:

HEXA_44

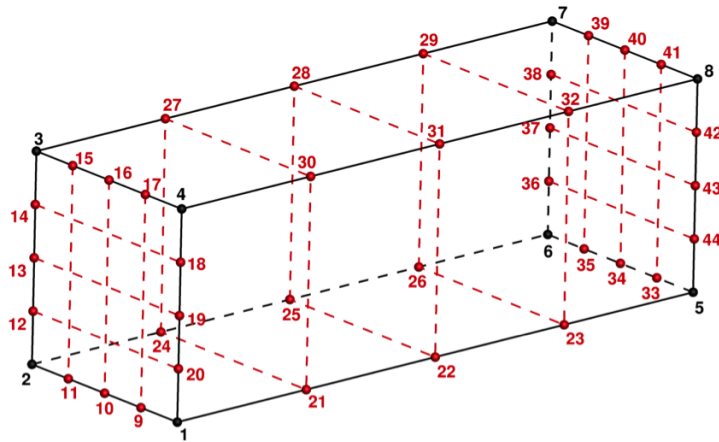

HEXA_98

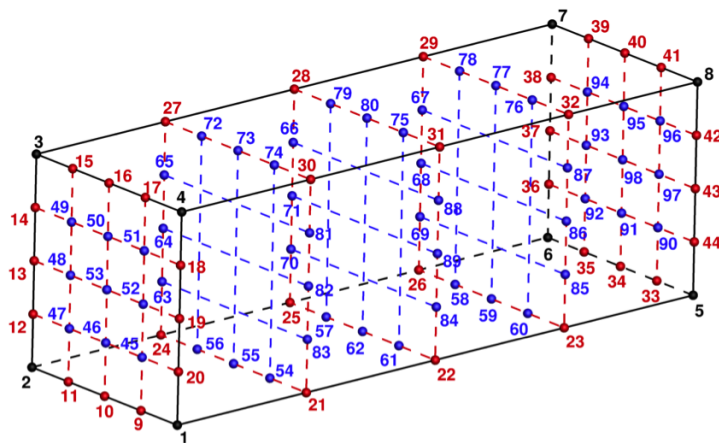

HEXA_125

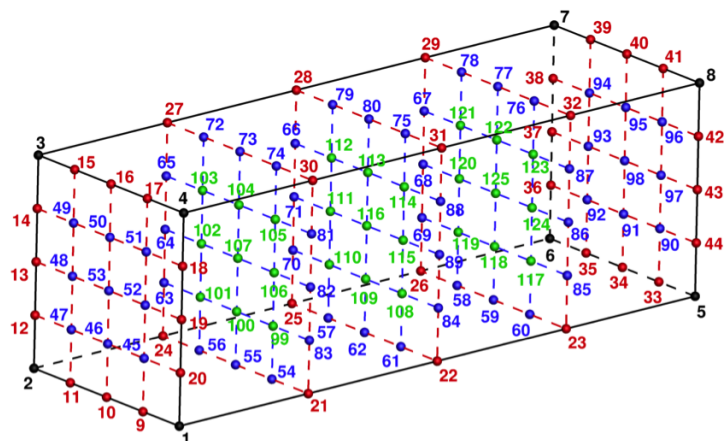

Edge Definition

<u>Oriented edges</u>	<u>Corner nodes</u>	<u>Mid-node</u>
E1	N1,N2	N9,N10,N11
E2	N2,N3	N12,N13,N14
E3	N3,N4	N15,N16,N17
E4	N4,N1	N18,N19,N20
E5	N1,N5	N21,N22,N23
E6	N2,N6	N24,N25,N26
E7	N3,N7	N27,N28,N29
E8	N4,N8	N30,N31,N32
E9	N5,N6	N33,N34,N35
E10	N6,N7	N36,N37,N38
E11	N7,N8	N39,N40,N41
E12	N8,N5	N42,N43,N44

Face Definition

Face	Corner nodes	Mid-edge nodes	Mid-face node	Oriented edges
F1	N1,N4,N3,N2	N20,N19,N18,N17,N16,N15, N14,N13,N12,N11,N10,N9	N45,N46,N47,N48,N49, N50,N51,N52,N53	-E4,-E3,-E2,-E1
F2	N1,N2,N6,N5	N9,N10,N11,N24,N25,N26, N35,N34,N33,N23,N22,N21	N54,N55,N56,N57,N58, N59,N60,N61,N62	E1, E6, -E9, -E5
F3	N2,N3,N7,N6	N12,N13,N14,N27,N28,N29, N38,N37,N36,N26,N25,N24	N63,N64,N65,N66,N67, N68,N69,N70,N71	E2, E7, -E10,-E6
F4	N3,N4,N8,N7	N15,N16,N17,N30,N31,N32, N41,N40,N39,N29,N28,N27	N72,N73,N74,N75,N76, N77,N78,N79,N80	E3, E8, -E11,-E7
F5	N1,N5,N8,N4	N21,N22,N23,N44,N43,N42, N32,N31,N30,N18,N19,N20	N81,N82,N83,N84,N85, N86,N87,N88,N89	E5,-E12,-E8, E4
F6	N5,N6,N7,N8	N33,N34,N35,N36,N37,N38, N39,N40,N41,N42,N43,N44	N90,N91,N92,N93,N94, N95,N96,N97,N98	E9, E10, E11, E12

3.3.4 Unstructured Grid Example

Consider an unstructured zone in the shape of a cube, with each edge of the zone having three nodes. The resulting unstructured grid has a total of 27 nodes, as illustrated in the exploded [Figure 2](#).

This zone contains eight hexahedral cells, numbered 1 to 8, and the cell connectivity is shown in [Table 2](#).

Table 2: Cell Connectivity for Example Unstructured Cube

Element No.	Element Connectivity
1	1, 2, 5, 4, 10, 11, 14, 13
2	2, 3, 6, 5, 11, 12, 15, 14
3	4, 5, 8, 7, 13, 14, 17, 16
4	5, 6, 9, 8, 14, 15, 18, 17
5	10, 11, 14, 13, 19, 20, 23, 22
6	11, 12, 15, 14, 20, 21, 24, 23
7	13, 14, 17, 16, 22, 23, 26, 25
8	14, 15, 18, 17, 23, 24, 27, 26

In addition to the cells, the boundary faces could also be added to the element definition of this unstructured zone. There are 24 boundary faces in this zone, corresponding to element numbers 9 to 32. Each boundary face is of type QUAD_4. [Table 3](#) shows the element connectivity of each boundary face, as well as the element number and face number of its parent cell.

Table 3: Boundary Face Connectivity for Example Unstructured Cube

Face	Element No.	Element Connectivity	Parent Cell	Parent Face
Left	9	1, 10, 13, 4	1	5
	10	4, 13, 16, 7	3	5
	11	10, 19, 22, 13	5	5
	12	13, 22, 25, 16	7	5
Right	13	3, 6, 15, 12	2	3
	14	6, 9, 18, 15	4	3
	15	12, 15, 24, 21	6	3
	16	15, 18, 27, 24	8	3
Bottom	17	1, 2, 11, 10	1	2
	18	2, 3, 12, 11	2	2
	19	10, 11, 20, 19	5	2
	20	11, 12, 21, 20	6	2
Top	21	7, 16, 17, 8	3	4
	22	8, 17, 18, 9	4	4
	23	16, 25, 26, 17	7	4
	24	17, 26, 27, 18	8	4
Back	25	1, 4, 5, 2	1	1
	26	2, 5, 6, 3	2	1
	27	4, 7, 8, 5	3	1
	28	5, 8, 9, 6	4	1
Front	29	19, 20, 23, 22	5	6
	30	20, 21, 24, 23	6	6
	31	22, 23, 26, 25	7	6
	32	23, 24, 27, 26	8	6

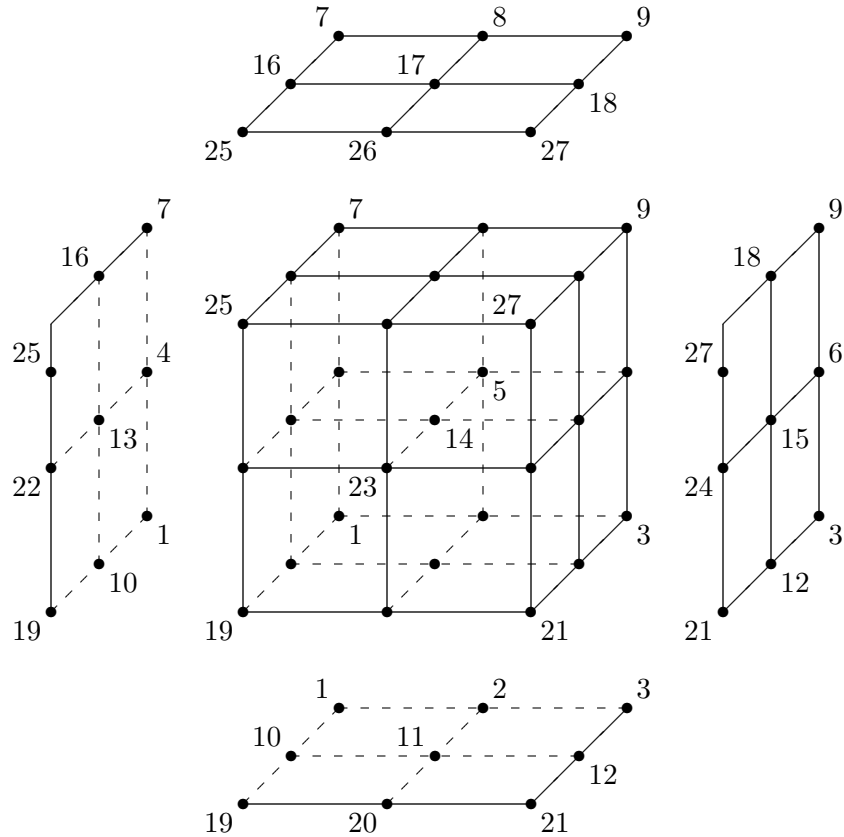

Figure 2: Example Unstructured Cube (Exploded View)

3.4 Multizone Interfaces

Figure 3 depicts three types of multizone interfaces, shown for structured zones. The first type is a 1-to-1 abutting interface, also referred to as matching or C0 continuous. The interface is a plane of vertices that are physically coincident between the adjacent zones. For structured zones, grid-coordinate lines perpendicular to the interface are continuous from one zone to the next; in 3-D, a 1-to-1 abutting interface is usually a logically rectangular region.

The second type of interface is mismatched abutting, where two zones touch but do not overlap (except for vertices and cell faces on the grid plane of the interface). Vertices on the interface may not be physically coincident between the two zones. Figure 3b identifies the vertices and face centers of the left zone that lay on the interface. Even for structured zones in 3-D, the vertices of a zone that constitute an interface patch may not form a logically rectangular region.

The third type of multizone interface is called overset and occurs when two zones overlap; in 3-D, the overlap is a 3-D region. For overset interfaces, one of the two zones takes precedence over the other; this establishes which solution in the overlap region to retain and which to discard. The region in a given zone where the solution is discarded is called an overset hole and the grid points outlining the hole are called fringe points. Figure 3c depicts an overlap region between two zones. The right zone takes precedence over the left zone, and the points identified in the figure are the fringe points and overset-hole points for the left zone. In addition, for the zone taking precedence,

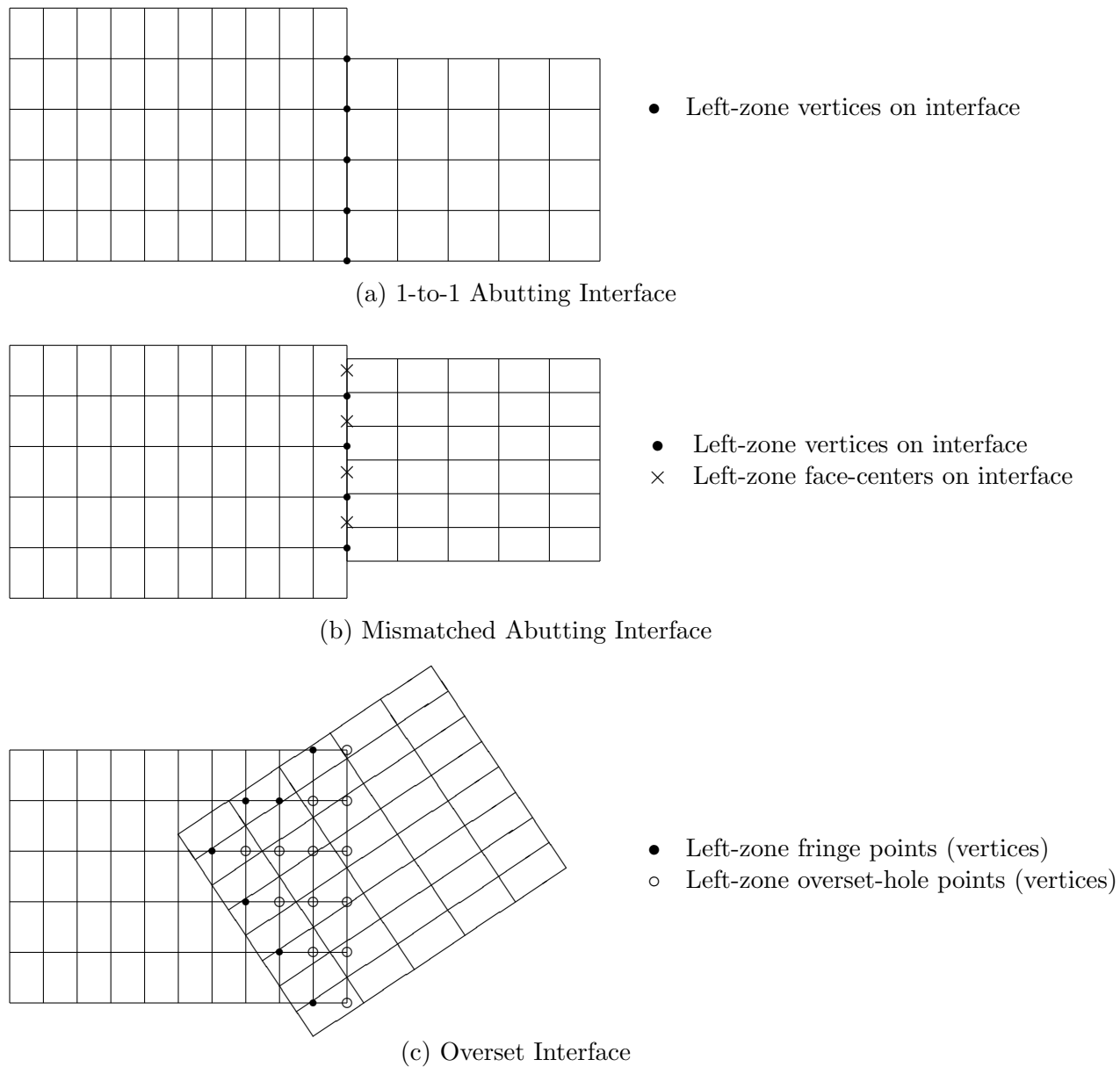

Figure 3: Structured-Grid Multizone Interface Types

any bounding points (i.e., vertices on the bounding faces) of the zone that lay within the overlap region must also be identified.

Overset interfaces may also include multiple layers of fringe points outlining holes and at zone boundaries.

For the mismatched abutting and overset interfaces in [Figure 3](#), the left zone plays the role of receiver zone and the right plays the role of donor zone.

4 Building-Block Structure Definitions

This section defines and describes low-level structures types that are used in the definition of more complex structures within the hierarchy.

4.1 Definition: `DataClass_t`

`DataClass_t` is an enumeration type that identifies the class of a given piece of data.

```
DataClass_t := Enumeration(  
    DataClassNull,  
    DataClassUserDefined,  
    Dimensional,  
    NormalizedByDimensional,  
    NormalizedByUnknownDimensional,  
    NondimensionalParameter,  
    DimensionlessConstant ) ;
```

These classes divide data into different categories depending on dimensional units or normalization associated with the data. `Dimensional` specifies dimensional data. `NormalizedByDimensional` specifies nondimensional data that is normalized by dimensional reference quantities. In contrast, `NormalizedByUnknownDimensional` specifies nondimensional data typically found in completely nondimensional databases, where all field and reference data is nondimensional. `NondimensionalParameter` specifies nondimensional parameters such as Mach number and lift coefficient. Constants such as π are designated by `DimensionlessConstant`. The distinction between these different classes is further discussed in [Section 5](#).

4.2 Definition: `Descriptor_t`

`Descriptor_t` is a documentation or annotation structure that contains a character string. Characters allowed within the string include newlines, tabs and other special characters; this potentially allows for unlimited documentation inclusion within the database. For example, a single `Descriptor_t` structure could be used to “swallow” an entire ASCII file. In the hierarchical structures defined in the next sections, each allows for the inclusion of multiple `Descriptor_t` substructures. Conventions could be made for names of often-used `Descriptor_t` structure entities, such as `ReadMe` or `YouReallyWantToReadMeFirst`.

```
Descriptor_t :=  
    {  
        Data(char, 1, string_length) ;  
    } ;
```

(r)

where `string_length` is the length of the character string.

4.3 Definition: DimensionalUnits_t

DimensionalUnits_t describes the system of units used to measure dimensional data. It is composed of a set of enumeration types that define the units for mass, length, time, temperature, angle, electric current, substance amount, and luminous intensity.

```
MassUnits_t           := Enumeration( MassUnitsNull, MassUnitsUserDefined,
                                     Kilogram, Gram, Slug, PoundMass ) ;

LengthUnits_t        := Enumeration( LengthUnitsNull, LengthUnitsUserDefined,
                                     Meter, Centimeter, Millimeter, Foot,
                                     Inch ) ;

TimeUnits_t          := Enumeration( TimeUnitsNull, TimeUnitsUserDefined,
                                     Second ) ;

TemperatureUnits_t   := Enumeration( TemperatureUnitsNull,
                                     TemperatureUnitsUserDefined, Kelvin,
                                     Celsius, Rankine, Fahrenheit ) ;

AngleUnits_t         := Enumeration( AngleUnitsNull, AngleUnitsUserDefined,
                                     Degree, Radian ) ;

ElectricCurrentUnits_t := Enumeration( ElectricCurrentUnitsNull,
                                       ElectricCurrentUnitsUserDefined, Ampere,
                                       Abampere, Statampere, Edison, auCurrent ) ;

SubstanceAmountUnits_t := Enumeration( SubstanceAmountUnitsNull,
                                       SubstanceAmountUnitsUserDefined, Mole,
                                       Entities, StandardCubicFoot,
                                       StandardCubicMeter ) ;

LuminousIntensityUnits_t := Enumeration( LuminousIntensityUnitsNull,
                                       LuminousIntensityUnitsUserDefined,
                                       Candela, Candle, Carcel, Hefner, Violle ) ;

DimensionalUnits_t :=
{
  MassUnits_t           MassUnits ;           (r)
  LengthUnits_t        LengthUnits ;         (r)
  TimeUnits_t          TimeUnits ;           (r)
  TemperatureUnits_t   TemperatureUnits ;    (r)
  AngleUnits_t         AngleUnits ;          (r)
  AdditionalUnits_t    :=                   (o)
```



```

{
  ElectricCurrentUnits_t   ElectricCurrentUnits ;           (r)
  SubstanceAmountUnits_t   SubstanceAmountUnits ;         (r)
  LuminousIntensityUnits_t LuminousIntensityUnits ;       (r)
}
} ;

```

The International System (SI) uses the following units.

Physical Quantity	Unit
Mass	Kilogram
Length	Meter
Time	Second
Temperature	Kelvin
Angle	Radian
Electric Current	Ampere
Substance Amount	Mole
Luminous Intensity	Candela

For an entity of type `DimensionalUnits_t`, if all the elements of that entity have the value `Null` (i.e., `MassUnits = MassUnitsNull`, etc.), this is equivalent to stating that the data described by the entity is nondimensional.

4.4 Definition: `DimensionalExponents_t`

`DimensionalExponents_t` describes the dimensionality of data by defining the exponents associated with each of the fundamental units.

```

DimensionalExponents_t :=
{
  real MassExponent ;           (r)
  real LengthExponent ;       (r)
  real TimeExponent ;         (r)
  real TemperatureExponent ;  (r)
  real AngleExponent ;        (r)
  AdditionalExponents_t :=    (o)
  {
    real ElectricCurrentExponent ; (r)
    real SubstanceAmountExponent ; (r)
    real LuminousIntensityExponent ; (r)
  }
} ;

```

For example, an instance of `DimensionalExponents_t` that describes velocity is,

```
DimensionalExponents_t =
  {{
    MassExponent      = 0 ;
    LengthExponent    = +1 ;
    TimeExponent      = -1 ;
    TemperatureExponent = 0 ;
    AngleExponent     = 0 ;
  }} ;
```

4.5 Definition: `GridLocation_t`

`GridLocation_t` identifies locations with respect to the grid; it is an enumeration type.

```
GridLocation_t := Enumeration(
  GridLocationNull,
  GridLocationUserDefined,
  Vertex,
  CellCenter,
  FaceCenter,
  IFaceCenter,
  JFaceCenter,
  KFaceCenter,
  EdgeCenter ) ;
```

`Vertex` is coincident with the grid vertices. `CellCenter` is the center of a cell; this is also appropriate for entities associated with cells but not necessarily with a given location in a cell. For structured zones, `IFaceCenter` is the center of a face in 3-D whose computational normal points in the i direction. `JFaceCenter` and `KFaceCenter` are similarly defined, again only for structured zones. `FaceCenter` is the center of a generic face that can point in any coordinate direction. These are also appropriate for entities associated with a face, but not located at a specific place on the face. `EdgeCenter` is the center of an edge. See [Section 3.2](#) for descriptions of cells, faces and edges.

All of the entities of type `GridLocation_t` defined in this document use a default value of `Vertex`.

4.6 Definition: `IndexArray_t`

`IndexArray_t` specifies an array of indices. An argument is included that allows for specifying the data type of each index; typically the data type will be integer (`int`). `IndexArray_t` defines an array of indices of size `ArraySize`, where the dimension of each index is `IndexDimension`.

```
IndexArray_t< int IndexDimension, int ArraySize, DataType > :=
  {
    Data( DataType, 2, [IndexDimension,ArraySize] ) ;           (r)
  } ;
```

4.7 Definition: IndexRange_t

`IndexRange_t` specifies the beginning and ending indices of a subrange. The subrange may describe a portion of a grid line, grid plane, or grid volume.

```
IndexRange_t< int IndexDimension > :=
{
  int[IndexDimension] Begin ;           (r)
  int[IndexDimension] End ;           (r)
} ;
```

where `Begin` and `End` are the indices of the opposing corners of the subrange.

4.8 Definition: Rind_t

`Rind_t` describes the number of rind planes (for structured grids) or rind points and elements (for unstructured grids) associated with a data array containing grid coordinates, flow-solution data or any other grid-related discrete data.

```
Rind_t< int IndexDimension > :=
{
  int[2*IndexDimension] RindPlanes ;   (r)
} ;
```

For structured grids, `RindPlanes` contains the number of rind planes attached to the minimum and maximum faces of a zone. The face corresponding to each index n of `RindPlanes` in 3-D is:

$$\begin{array}{ll} n = 1 \rightarrow i\text{-min} & n = 2 \rightarrow i\text{-max} \\ n = 3 \rightarrow j\text{-min} & n = 4 \rightarrow j\text{-max} \\ n = 5 \rightarrow k\text{-min} & n = 6 \rightarrow k\text{-max} \end{array}$$

For a 3-D grid whose “core” size is $II \times JJ \times KK$, a value of `RindPlanes = [a,b,c,d,e,f]` indicates that the range of indices for the grid with rind is:

$$\begin{array}{l} i: (1 - a, II + b) \\ j: (1 - c, JJ + d) \\ k: (1 - e, KK + f) \end{array}$$

For unstructured grids, `RindPlanes` does not actually contain planes, but rather contains the number of rind points or elements. The points are defined by the grid coordinates `rind node`, and the elements by the element set `rind node`. Note that to maintain consistency with the structured usage of `Rind_t`, `RindPlanes` is still dimensioned `2*IndexDimension` for unstructured grids (and, for unstructured grids, `IndexDimension = 1`). The first `RindPlanes` value is the number of rind nodes/elements stored before the core data, and the second is the number stored after. Thus `RindPlanes[2] = [1 2]` would mean there is one rind value before the core data, and two after the core data. However, it is preferable to write all the rind points or elements at the *end* of the array; in other words, for unstructured grids `RindPlanes[2]` should be set to `[0 nrind]`, where `nrind` is the number of rind points or elements.

5 Data-Array Structure Definitions

This section defines the structure type `DataArray_t` for describing data arrays. This general-purpose structure is used to declare data arrays and scalars throughout the CGNS hierarchy. It is used to describe grid coordinates, flow-solution data, governing flow parameters, boundary-condition data, and other information. For most of these different types of CFD data, we have also established a list of standardized identifiers for entities of type `DataArray_t`. For example, `Density` is used for data arrays containing static density. The list of standardized data-name identifiers is provided in [Appendix A](#).

We address five classes of data with the `DataArray_t` structure type:

- (a) dimensional data (e.g., velocity in units of m/s);
- (b) nondimensional data normalized by dimensional reference quantities;
- (c) nondimensional data with associated nondimensional reference quantities;
- (d) nondimensional parameters (e.g., Reynolds number, pressure coefficient);
- (e) pure constants (e.g., π , e).

The first two of these classes often occur within the same test case, where each piece of data is either dimensional itself or normalized by a dimensional quantity. The third data class is typical of a completely nondimensional test case, where all field data and reference quantities are nondimensional. The fourth class, nondimensional parameters, are universal in CFD, although not always consistently defined. The individual components of nondimensional parameters may be data from any of the first three classes.

Each of the five classes of data requires different information to describe dimensional units or normalization associated with the data. These requirements are reflected in the structure definition for `DataArray_t`.

The remainder of this section is as follows: the structure type `DataArray_t` is first defined. Then the class identification and data manipulation is discussed in [Section 5.2](#) for each of the five data classes. Finally, examples of `DataArray_t` entities are presented in [Section 5.3](#).

5.1 Definition: `DataArray_t`

`DataArray_t` describes a multi-dimensional data array of given type, dimensionality and size in each dimension. The data may be dimensional, nondimensional or pure constants. Qualifiers are provided to describe dimensional units or normalization information associated with the data.

```
DataArray_t< DataType, int Dimension, int[Dimension] DimensionValues > :=  
  {  
    List( Descriptor_t Descriptor1 ... DescriptorN ) ;           (o)  
  
    Data( DataType, Dimension, DimensionValues ) ;           (r)
```

```
DataClass_t DataClass ; (o)
DimensionalUnits_t DimensionalUnits ; (o)
DimensionalExponents_t DimensionalExponents ; (o)
DataConversion_t DataConversion ; (o)
} ;
```

Notes

1. Default names for the `Descriptor_t` list are as shown; users may choose other legitimate names. Legitimate names must be unique within a given instance of `DataArray_t` and shall not include the names `DataClass`, `DimensionalUnits`, `DimensionalExponents`, or `DataConversion`.
2. `Data()` is the only required field for `DataArray_t`.

`DataArray_t` requires three structure parameters: `Dimension` is the dimensionality of the data array; `DimensionValues` is an array of length `Dimension` that contains the size of the data arrays in each dimension; and `DataType` is the data type of the data stored. `DataType` will usually be `real`, but other data types are permissible.

The optional entities `DataClass`, `DimensionalUnits`, `DimensionalExponents` and `DataConversion` provide information on dimensional units and normalization associated with the data. The function of these qualifiers is provided in the next section.

This structure type is formulated to describe an array of scalars. Therefore, for vector quantities (e.g., the position vector or the velocity vector), separate structure entities are required for each component of the vector. For example, the Cartesian coordinates of a 3-D grid are described by three separate `DataArray_t` entities: one for x , one for y and one for z (see [Example 7-A](#)).

5.1.1 Definition: `DataConversion_t`

`DataConversion_t` contains conversion factors for recovering raw dimensional data from given nondimensional data. These conversion factors are typically associated with nondimensional data that is normalized by dimensional reference quantities.

```
DataConversion_t :=
{
  real ConversionScale ; (r)
  real ConversionOffset ; (r)
} ;
```

Given a nondimensional piece of data, `Data(nondimensional)`, the conversion to “raw” dimensional form is:

`Data(raw) = Data(nondimensional)*ConversionScale + ConversionOffset`

These conversion factors are further described in [Section 5.2.2](#).

5.2 Data Manipulation

The optional entities of `DataArray_t` provide information for manipulating the data, including changing units or normalization. This section describes the rules under which these optional entities operate and the specific manipulations that can be performed on the data.

Within a given instance of `DataArray_t`, the class of data and all information required for manipulations may be completely and precisely specified by the entities `DataClass`, `DimensionalUnits`, `DimensionalExponents` and `DataConversion`. `DataClass` identifies the class of data and governs the manipulations that can be performed. Each of the five data classes is treated separately in the subsequent sections.

The entities `DataClass` and `DimensionalUnits` serve special functions in the CGNS hierarchy. If `DataClass` is absent from a given instance of `DataArray_t`, then its value is determined from “global” data. This global data may be set at any level of the CGNS hierarchy with the data set at the lowest level taking precedence. `DimensionalUnits` may be similarly set by global data. The rules for determining the appropriate set of global data to apply is further detailed in [Section 6.4](#).

This alternate functionality provides a measure of economy in describing dimensional units or normalization within the hierarchy. Examples that make use of global data are presented in [Section 7.2](#) and [Section 7.8](#) for grid and flow solution data. The complete two-zone case of [Appendix B](#) also depicts this alternate functionality.

5.2.1 Dimensional Data

If `DataClass = Dimensional`, the data is dimensional. The optional qualifiers `DimensionalUnits` and `DimensionalExponents` describe dimensional units associated with the data. These qualifiers are provided to specify the system of dimensional units and the dimensional exponents, respectively. For example, if the data is the x -component of velocity, then `DimensionalUnits` will state that the pertinent dimensional units are, say, `Meter` and `Second`; `DimensionalExponents` will specify that the pertinent dimensional exponents are `LengthExponent = 1` and `TimeExponent = -1`. Combining the information gives the units m/s. Examples showing the use of these two qualifiers are provided in [Section 5.3](#).

If `DimensionalUnits` is absent, then the appropriate set of dimensional units is obtained from “global” data. The rules for determining this appropriate set of global dimensional units are presented in [Section 6.4](#).

If `DimensionalExponents` is absent, then the appropriate dimensional exponents can be determined by convention if the specific instance of `DataArray_t` corresponds to one of the standardized data-name identifiers listed in [Appendix A](#). Otherwise, the exponents are unspecified. We strongly recommend inclusion of the `DimensionalExponents` qualifier whenever the data is dimensional and the instance of `DataArray_t` is not among the list of standardized identifiers.

5.2.2 Nondimensional Data Normalized by Dimensional Quantities

If `DataClass = NormalizedByDimensional`, the data is nondimensional and is normalized by dimensional reference quantities. All optional entities in `DataArray_t` are used. `DataConversion` contains factors to convert the nondimensional data to “raw” dimensional data; these factors are `ConversionScale` and `ConversionOffset`. The conversion process is as follows:

$$\text{Data}(\text{raw}) = \text{Data}(\text{nondimensional}) * \text{ConversionScale} + \text{ConversionOffset}$$

where `Data(nondimensional)` is the original nondimensional data, and `Data(raw)` is the converted raw data. This converted raw data is dimensional, and the optional qualifiers `DimensionalUnits` and `DimensionalExponents` describe the appropriate dimensional units and exponents. Note that `DimensionalUnits` and `DimensionalExponents` also describe the units for `ConversionScale` and `ConversionOffset`.

If `DataConversion` is absent, the equivalent defaults are `ConversionScale = 1` and `ConversionOffset = 0`. If either `DimensionalUnits` or `DimensionalExponents` is absent, follow the rules described in the previous section.

Note that functionally there is little difference between these first two data classes (`DataClass = Dimensional` and `NormalizedByDimensional`). In the first case the data is dimensional, and in the second, the converted raw data is dimensional. Also, the equivalent defaults for `DataConversion` produce no changes in the data; hence, it is almost the same as stating the original data is dimensional.

5.2.3 Nondimensional Data Normalized by Unknown Dimensional Quantities

If `DataClass = NormalizedByUnknownDimensional`, the data is nondimensional and is normalized by some unspecified dimensional quantities. This type of data is typical of a completely nondimensional test case, where all field data and all reference quantities are nondimensional.

Only the `DimensionalExponents` qualifier is used in this case, although it is expected that this qualifier will be seldom utilized in practice. For entities of `DataArray_t` that are not among the list of standardized data-name identifiers, the qualifier could provide useful information by defining the exponents of the dimensional form of the nondimensional data.

Rather than providing qualifiers to describe the normalization of the data, we instead dictate that all data of type `NormalizedByUnknownDimensional` in a given database be nondimensionalized consistently. This is done by picking one set of mass, length, time and temperature scales and normalizing all appropriate data by these scales. We describe this process in detail in the following. [Appendix B](#) also shows a completely nondimensional database where consistent normalization is used throughout.

The practice of nondimensionalization within flow solvers and other application codes is quite popular. The problem with this practice is that to manipulate the data from a given code, one must often know the particulars of the nondimensionalization used. This largely results from what we call inconsistent normalization—more than the minimum required scales are used to normalize data

within the code. For example, in the OVERFLOW flow solver, the following nondimensionalization is used:

$$\begin{aligned}\tilde{x} &= x/L, & \tilde{u} &= u/c_\infty, & \tilde{\rho} &= \rho/\rho_\infty, \\ \tilde{y} &= y/L, & \tilde{v} &= v/c_\infty, & \tilde{p} &= p/(\rho_\infty c_\infty^2), \\ \tilde{z} &= z/L, & \tilde{w} &= w/c_\infty, & \tilde{\mu} &= \mu/\mu_\infty,\end{aligned}$$

where (x, y, z) are the Cartesian coordinates, (u, v, w) are the Cartesian components of velocity, ρ is static density, p is static pressure, c is the static speed of sound, and μ is the molecular viscosity. In this example, tilde quantities ($\tilde{}$) are nondimensional and all others are dimensional. Four dimensional scales are used for normalization: L (a unit length), ρ_∞ , c_∞ and μ_∞ . However, only three fundamental dimensional units are represented: mass, length and time. The extra normalizing scale leads to inconsistent normalization. The primary consequence of this is additional nondimensional parameters, such as Reynolds number, appearing in the nondimensionalized governing equations where none are found in the original dimensional equations. Many definitions, including skin friction coefficient, also have extra terms appearing in the nondimensionalized form. This adds unnecessary complication to any data or equation manipulation associated with the flow solver.

Consistent normalization avoids many of these problems. Here the number of scales used for normalization is the same as the number of fundamental dimensional units represented by the data. Using consistent normalization, the resulting nondimensionalized form of equations and definitions is identical to their original dimensional formulations. One piece of evidence to support this assertion is that it is not possible to form any nondimensional parameters from the set of dimensional scales used for normalization.

An important fallout of consistent normalization is that the actual scales used for normalization become immaterial for all data manipulation processes. To illustrate this consider the following nondimensionalization procedure: let M (mass), L (length) and T (time) be arbitrary dimensional scales by which all data is normalized (neglect temperature data for the present). The nondimensional data follows:

$$\begin{aligned}x' &= x/L, & u' &= u/(L/T), & \rho' &= \rho/(M/L^3), \\ y' &= y/L, & v' &= v/(L/T), & p' &= p/(M/(LT^2)), \\ z' &= z/L, & w' &= w/(L/T), & \mu' &= \mu/(M/(LT)),\end{aligned}$$

where primed quantities are nondimensional and all others are dimensional.

Consider an existing database where all field data and all reference data is nondimensional and normalized as shown. Assume the database has a single reference state given by,

$$\begin{aligned}x'_{\text{ref}} &= x_{\text{ref}}/L, & u'_{\text{ref}} &= u_{\text{ref}}/(L/T), & \rho'_{\text{ref}} &= \rho_{\text{ref}}/(M/L^3), \\ y'_{\text{ref}} &= y_{\text{ref}}/L, & v'_{\text{ref}} &= v_{\text{ref}}/(L/T), & p'_{\text{ref}} &= p_{\text{ref}}/(M/(LT^2)) \\ z'_{\text{ref}} &= z_{\text{ref}}/L, & w'_{\text{ref}} &= w_{\text{ref}}/(L/T), & \mu'_{\text{ref}} &= \mu_{\text{ref}}/(M/(LT)).\end{aligned}$$

If a user wanted to change the nondimensionalization of grid-point pressures, the procedure is straightforward. Let the desired new normalization be given by $p''_{ijk} = p_{ijk}/(\rho_{\text{ref}} c_{\text{ref}}^2)$, where all terms on the right-hand-side are *dimensional*, and as such they are unknown to the database user. However, the desired manipulation is possible using only nondimensional data provided in the

database,

$$\begin{aligned} p''_{ijk} &\equiv p_{ijk}/(\rho_{\text{ref}}c_{\text{ref}}^2) \\ &= \frac{p_{ijk}}{M/(LT^2)} \frac{M/L^3}{\rho_{\text{ref}}} \left[\frac{L/T}{c_{\text{ref}}} \right]^2 \\ &= p'_{ijk}/(\rho'_{\text{ref}}(c'_{\text{ref}})^2) \end{aligned}$$

Thus, the desired renormalization is possible using the database's nondimensional data as if it were actually dimensional. There is, in fact, a high degree of equivalence between dimensional data and consistently normalized nondimensional data. The procedure shown in this example should extend to any desired renormalization, provided the needed reference-state quantities are included in the database.

This example points out two stipulations that we now dictate for data in the class `NormalizedByUnknownDimensional`,

- (a) All nondimensional data within a given database that has `DataClass = NormalizedByUnknownDimensional` shall be consistently normalized.
- (b) Any nondimensional reference state appearing in a database should be sufficiently populated with reference quantities to allow for renormalization procedures.

The second of these stipulations is somewhat ambiguous, but good practice would suggest that a flow solver, for example, should output to the database enough static and/or stagnation reference quantities to sufficiently define the state.

[Appendix B](#) shows an example of a well-populated reference state.

With these two stipulations, we contend the following:

- The dimensional scales used to nondimensionalize all data are immaterial, and there is no need to identify these quantities in a CGNS database.
- The dimensional scales need not be reference-state quantities provided in the database. For example, a given database could contain freestream reference state conditions, but all the data is normalized by sonic conditions (which are not provided in the database).
- All renormalization procedures can be carried out treating the data as if it were dimensional with a consistent set of units.
- Any application code that internally uses consistent normalization can use the data provided in a CGNS database without modification or transformation to the code's internal normalization.

Before ending this section, we note that the OVERFLOW flow solver mentioned above (or any other application code that internally uses inconsistent normalization) could easily read and write data to a nondimensional CGNS database that conforms to the above stipulations. On output, the code could renormalize data so it is consistently normalized. Probably, the easiest method would be to remove the molecular viscosity scale (μ_∞), and only use L , ρ_∞ and c_∞ for all normalizations

(recall these are dimensional scales). The only change from the above example would be the nondimensionalization of viscosity, which would become, $\tilde{\mu} = \mu/(\rho_\infty c_\infty L)$. The code could then output all field data as,

$$\begin{aligned}\tilde{x}_{ijk} &= x_{ijk}/L, & \tilde{u}_{ijk} &= u_{ijk}/c_\infty, & \tilde{\rho}_{ijk} &= \rho_{ijk}/\rho_\infty, \\ \tilde{y}_{ijk} &= y_{ijk}/L, & \tilde{v}_{ijk} &= v_{ijk}/c_\infty, & \tilde{p}_{ijk} &= p_{ijk}/(\rho_\infty c_\infty^2), \\ \tilde{z}_{ijk} &= z_{ijk}/L, & \tilde{w}_{ijk} &= w_{ijk}/c_\infty, & \tilde{\mu}_{ijk} &= \mu_{ijk}/(\rho_\infty c_\infty L),\end{aligned}$$

and output the freestream reference quantities,

$$\begin{aligned}\tilde{u}_\infty &= u_\infty/c_\infty, & \tilde{\rho}_\infty &= \rho_\infty/\rho_\infty = 1, \\ \tilde{v}_\infty &= v_\infty/c_\infty, & \tilde{p}_\infty &= p_\infty/(\rho_\infty c_\infty^2) = 1/\gamma, \\ \tilde{w}_\infty &= w_\infty/c_\infty, & \tilde{\mu}_\infty &= \mu_\infty/(\rho_\infty c_\infty L) \sim O(1/Re), \\ \tilde{c}_\infty &= c_\infty/c_\infty = 1, & \tilde{L} &= L/L = 1,\end{aligned}$$

where γ is the specific heat ratio (assumes a perfect gas) and Re is the Reynolds number.

On input, the flow solver should be able to recover its internal normalizations from the data in a nondimensional CGNS database by treating the data as if it were dimensional.

5.2.4 Nondimensional Parameters

If `DataClass = NondimensionalParameter`, the data is a nondimensional parameter (or array of nondimensional parameters). Examples include Mach number, Reynolds number and pressure coefficient. These parameters are prevalent in CFD, although their definitions tend to vary between different application codes. A list of standardized data-name identifiers for nondimensional parameters is provided in [Appendix A.4](#).

We distinguish nondimensional parameters from other data classes by the fact that they are *always* dimensionless. In a completely nondimensional database, they are distinct in that their normalization is not necessarily consistent with other data.

Typically, the `DimensionalUnits`, `DimensionalExponents` and `DataConversion` qualifiers are not used for nondimensional parameters; although, there are a few situations where they may be used (these are discussed below). Rather than rely on optional qualifiers to describe the normalization, we establish the convention that *any nondimensional parameters should be accompanied by their defining scales*; this is further discussed in [Appendix A.4](#). An example is Reynolds number defined as $Re = VL_R/\nu$, where V , L_R and ν are velocity, length, and viscosity scales, respectively. Note that these defining scales may be dimensional or nondimensional data. We establish the data-name identifiers `Reynolds`, `Reynolds_Velocity`, `Reynolds_Length` and `Reynolds_ViscosityKinematic` for the Reynolds number and its defining scales. Anywhere an instance of `DataArray_t` is found with the identifier `Reynolds`, there should also be entities for the defining scales. An example of this use for Reynolds number is given in [Section 5.3](#).

In certain situations, it may be more convenient to use the optional qualifiers of `DataArray_t` to describe the normalization used in nondimensional parameters. These situations must satisfy two requirements: First, the defining scales are dimensional; and second, the nondimensional parameter is a normalization of a single “raw” data quantity and it is clear what this raw data is. Examples

that satisfy this second constraint are pressure coefficient, where the raw data is static pressure, and lift coefficient, where the raw data is the lift force. Conversely, Reynolds number is a parameter that violates the second requirement—there are three pieces of raw data rather than one that make up Re . For nondimensional parameters that satisfy these two requirements, the qualifiers `DimensionalUnits`, `DimensionalExponents` and `DataConversion` may be used as in [Section 5.2.2](#) to recover the raw dimensional data.

5.2.5 Dimensionless Constants

If `DataClass = DimensionlessConstant`, the data is a constant (or array of constants) with no associated dimensional units. The `DimensionalUnits`, `DimensionalExponents` and `DataConversion` qualifiers are not used.

5.3 Data-Array Examples

This section presents five examples of data-array entities and illustrates the use of optional information for describing dimensional and nondimensional data.

Example 5-A: One-Dimensional Data Array, Constants

A one-dimensional array of integers; the array is the integers from 1 to 10. The data is pure constants.

```
! DataType = int
! Dimension = 1
! DimensionValues = 10
DataArray_t<int, 1, 10> Data1 =
  {{
    Data(int, 1, 10) = [1, 2, 3, 4, 5, 6, 7, 8, 9, 10] ;

    DataClass_t DataClass = DimensionlessConstant ;
  }} ;
```

The structure parameters for `DataArray_t` state the data is an one-dimensional integer array of length ten. The value of `DataClass` indicates the data is unitless constants.

Example 5-B: Two-Dimensional Data Array, Pressures

A two-dimensional array of pressures with size 11×9 given by the array $P(i, j)$. The data is dimensional with units of N/m^2 (i.e., $kg/(m \cdot s^2)$). Note that `Pressure` is the data-name identifier for static pressure.

```
! DataType = real
! Dimension = 2
! DimensionValues = [11,9]
DataArray_t<real, 2, [11,9]> Pressure =
```

```

{{
Data(real, 2, [11,9]) = ((P(i,j), i=1,11), j=1,9) ;

DataClass_t DataClass = Dimensional ;

DimensionalUnits_t DimensionalUnits =
  {{
  MassUnits          = Kilogram ;
  LengthUnits        = Meter ;
  TimeUnits          = Second ;
  TemperatureUnits   = TemperatureUnitsNull ;
  AngleUnits         = AngleUnitsNull ;
  }} ;

DimensionalExponents_t DimensionalExponents =
  {{
  MassExponent       = +1 ;
  LengthExponent     = -1 ;
  TimeExponent       = -2 ;
  TemperatureExponent = 0 ;
  AngleExponent      = 0 ;
  }} ;
}} ;

```

From the data-name identifier conventions presented in [Appendix A](#), `Pressure` has a floating-point data type; hence, the appropriate structure parameter for `DataArray_t` is `real`.

The value of `DataClass` indicates that the data is dimensional, and both the dimensional units and dimensional exponents are provided. `DimensionalUnits` specifies that the units are kilograms, meters, and seconds, and `DimensionalExponents` specifies the appropriate exponents for pressure. Combining the information gives pressure as $\text{kg}/(\text{m}\cdot\text{s}^2)$. `DimensionalExponents` could have been defaulted, since the dimensional exponents are given in [Appendix A](#) for the data-name identifier `Pressure`.

Note that FORTRAN multidimensional array indexing is used to store the data; this is reflected in the FORTRAN-like implied do-loops for `P(i, j)`.

Example 5-C: Three-Dimensional Data Array, Nondimensional Static Enthalpy

A 3-D array of size $33 \times 9 \times 17$ containing nondimensional static enthalpy. The data is normalized by freestream velocity as follows:

$$\bar{h}_{i,j,k} = \frac{h_{i,j,k}}{q_{\text{ref}}^2},$$

where $\bar{h}_{i,j,k}$ is nondimensional static enthalpy. The freestream velocity is dimensional with a value of 10 m/s.

```
! DataType = real
```

```
! Dimension = 3
! DimensionValues = [33,9,17]
DataArray_t<real, 3, [33,9,17]> Enthalpy =
  {{
    Data(real, 3, [33,9,17]) = ((H(i,j,k), i=1,33), j=1,9), k=1,17) ;

    DataClass_t DataClass = NormalizedByDimensional ;

    DataConversion_t DataConversion =
      {{
        real ConversionScale = 100 ;
        real ConversionOffset = 0 ;
      }} ;

    DimensionalUnits_t DimensionalUnits =
      {{
        MassUnits          = MassUnitsNull ;
        LengthUnits        = Meter ;
        TimeUnits           = Second ;
        TemperatureUnits    = TemperatureUnitsNull ;
        AngleUnits          = AngleUnitsNull ;
      }} ;

    DimensionalExponents_t DimensionalExponents =
      {{
        MassExponent        = 0 ;
        LengthExponent      = +2 ;
        TimeExponent        = -2 ;
        TemperatureExponent = 0 ;
        AngleExponent       = 0 ;
      }} ;
  }} ;
```

From [Appendix A](#), the identifier for static enthalpy is `Enthalpy` and its data type is `real`.

The value of `DataClass` indicates that the data is nondimensional and normalized by a dimensional reference quantity. `DataConversion` provides the conversion factors for recovering the raw static enthalpy, which has units of m^2/s^2 as indicated by `DimensionalUnits` and `DimensionalExponents`. Note that `DimensionalExponents` could have been defaulted using the conventions for the data-name identifier `Enthalpy`.

Example 5-D: Three-Dimensional Data Array, Nondimensional Database

The previous example for nondimensional enthalpy is repeated for a completely nondimensional database.

```
! DataType = real
```

```

! Dimension = 3
! DimensionValues = [33,9,17]
DataArray_t<real, 3, [33,9,17]> Enthalpy =
  {{
    Data(real, 3, [33,9,17]) = ((H(i,j,k), i=1,33), j=1,9), k=1,17) ;

    DataClass_t DataClass = NormalizedByUnknownDimensional ;
  }} ;

```

The value of `DataClass` indicates the appropriate class.

Example 5-E: Data Arrays for Reynolds Number

Reynolds number of 1.554×10^6 based on a velocity scale of 10 m/s, a length scale of 2.3 m and a kinematic viscosity scale of 1.48×10^{-5} m²/s. Assume the database has globally set the dimensional units to kilograms, meters, and seconds, and the global default data class to dimensional (`DataClass = Dimensional`).

```

! DataType = real
! Dimension = 1
! DimensionValues = 1
DataArray_t<real, 1, 1> Reynolds =
  {{
    Data(real, 1, 1) = 1.554e+06 ;

    DataClass_t DataClass = NondimensionalParameter ;
  }} ;

DataArray_t<real, 1, 1> Reynolds_Velocity =
  {{
    Data(real, 1, 1) = 10. ;
  }} ;

DataArray_t<real, 1, 1> Reynolds_Length =
  {{
    Data(real, 1, 1) = 2.3 ;
  }} ;

DataArray_t<real, 1, 1> Reynolds_ViscosityKinematic =
  {{
    Data(real, 1, 1) = 1.48e-05 ;
  }} ;

```

`Reynolds` contains the value of the Reynolds number, and the value of its `DataClass` qualifier designates it as a nondimensional parameter. By conventions described in [Appendix A.4](#), the defining scales are contained in the associated entities `Reynolds_Velocity`, `Reynolds_Length`,

and `Reynolds_ViscosityKinematic`. Since each of these entities contain no qualifiers, global information is used to decipher that they are all dimensional with mass, length, and time units of kilograms, meters, and seconds. The structure parameters for each `DataArray_t` entity state that they contain a real scalar.

If a user wanted to convey the dimensional units of the defining scales using optional qualifiers of `DataArray_t`, then the last three entities in this example would have a form similar to that in [Example 5-B](#).

6 Hierarchical Structures

This section presents the structure-type definitions for the top levels of the CGNS hierarchy. As stated in [Section 2](#), the hierarchy is topologically based, where the overall organization is by zones. All information pertaining to a given zone, including grid coordinates, flow solution, and other related data, is contained within that zone's structure entity. [Figure 1](#) depicts this topologically based hierarchy. The CGNS version number is described in [Section 6.1](#). The CGNS database entry level structure type is defined in [Section 6.2](#), and the zone structure is defined in [Section 6.3](#). This section concludes with a discussion of globally applicable data.

6.1 CGNS Version

CGNS is an evolving standard. Although great care is taken to make CGNS databases backward-compatible with previous versions whenever possible, new nodes and new features are still being added that make them non-forward-compatible. To address this issue, each new version of the standard is labeled with a version number that should be written in the file. This version number corresponds to the version of the SIDS and is an essential part of the file containing the CGNS database. The file can not be interpreted properly without knowledge of this version number.

Physically, this version number is located directly under the root node of the file. The *SIDS File Mapping Manual* defines this location more precisely.

Historically, the version number was used to describe the version of the Mid-Level Library used to write or modify the file. The corresponding node was thus named `CGNSLibraryVersion_t`. With the advent of new libraries that can read and write CGNS databases, the node is now defined as the version of the CGNS standard. The Mid-Level Library modifies its interpretation of node data according to the CGNS version number, and other libraries should also.

6.2 CGNS Entry Level Structure Definition: `CGNSBase_t`

The highest level structure in a CGNS database is `CGNSBase_t`. This top level entity is designed to be self-contained, a complete CFD computation can be archived and reproduced using the data defined in the `CGNSBase`. However a CGNS tree can contain more than one base, these can be related to the same CFD case or not. The behavior of a multi-base CGNS tree is application dependant, even if inter-base relationships are authorized in three cases:

- A reference to another base's zone name (including its sub-nodes' names) as defined in the multi-zone connectivities (see [Section 8](#) and time-dependant pointers [Section 11](#));
- A reference to another base's family name (see [Section 12.6](#)) as as `FamilyName_t` data;
- A `LogicalLink()` from one base to another on any kind of node;

Care must be taken on precedence rules and scope in the case of parsing multiple CGNS bases (see [Section 6.4](#)).

The CGNS Base contains the cell dimension and physical dimension of the computational grid and lists of zones and families making up the domain. Globally applicable information, including a reference state, a set of flow equations, dimensional units, time step or iteration information, and convergence history are also attached. In addition, structures for describing or annotating the database are also provided; these same descriptive mechanisms are provided for structures at all levels of the hierarchy.

```
CGNSBase_t :=
{
  List( Descriptor_t Descriptor1 ... DescriptorN ) ;           (o)

  int CellDimension ;                                         (r)
  int PhysicalDimension ;                                     (r)

  BaseIterativeData_t BaseIterativeData ;                   (o)

  List( Zone_t<CellDimension, PhysicalDimension> Zone1 ... ZoneN ) ; (o)

  ReferenceState_t ReferenceState ;                          (o)

  Axisymmetry_t Axisymmetry ;                                (o)

  RotatingCoordinates_t RotatingCoordinates ;                (o)

  Gravity_t Gravity ;                                         (o)

  SimulationType_t SimulationType ;                           (o)

  DataClass_t DataClass ;                                     (o)

  DimensionalUnits_t DimensionalUnits ;                       (o)

  FlowEquationSet_t<CellDimension> FlowEquationSet ;         (o)

  ConvergenceHistory_t GlobalConvergenceHistory ;             (o)

  List( IntegralData_t IntegralData1... IntegralDataN ) ;    (o)

  List( Family_t Family1... FamilyN ) ;                       (o)

  List( UserDefinedData_t UserDefinedData1 ... UserDefinedDataN ) ; (o)
} ;
```

Notes

1. Default names for the Descriptor_t, Zone_t, IntegralData_t, Family_t, and UserDe-

`finnedData_t` lists are as shown; users may choose other legitimate names. Legitimate names must be unique at this level and shall not include the names `Axisymmetry`, `BaseIterativeData`, `DataClass`, `DimensionalUnits`, `FlowEquationSet`, `GlobalConvergenceHistory`, `Gravity`, `ReferenceState`, `RotatingCoordinates`, or `SimulationType`.

2. The number of entities of type `Zone_t` defines the number of zones in the domain.
3. `CellDimension` and `PhysicalDimension` are the only required fields. The `Descriptor_t`, `Zone_t` and `IntegralData_t` lists may be empty, and all other optional fields absent.

Note that we make the distinction between the following:

<code>IndexDimension</code>	Number of different indices required to reference a node (e.g., $1 = i$, $2 = i, j$, $3 = i, j, k$)
<code>CellDimension</code>	Dimensionality of the cell in the mesh (e.g., 3 for a volume cell, 2 for a face cell)
<code>PhysicalDimension</code>	Number of coordinates required to define a node position (e.g., 1 for 1-D, 2 for 2-D, 3 for 3-D)

These three dimensions may differ depending on the mesh. For example, an unstructured triangular surface mesh representing the wet surface of an aircraft will have:

- `IndexDimension` = 1 (always for unstructured)
- `CellDimension` = 2 (face elements)
- `PhysicalDimension` = 3 (needs x, y, z coordinates since it is a 3D surface)

For a structured zone, the quantities `IndexDimension` and `CellDimension` are always equal. For an unstructured zone, `IndexDimension` always equals 1. Therefore, storing `CellDimension` at the `CGNSBase_t` level will automatically define the `IndexDimension` value for each zone.

On the other hand we assume that all zones of the base have the same `CellDimension`, e.g., if `CellDimension` is 3, all zones must be composed of 3D cells within the `CGNSBase_t`.

We need `IndexDimension` for both structured and unstructured zones in order to use original data structures such as `GridCoordinates_t`, `FlowSolution_t`, `DiscreteData_t`, etc. `CellDimension` is necessary to express the interpolants in `ZoneConnectivity` with an unstructured zone (mismatch or overset connectivity). When the cells are bidimensional, two interpolants per node are required, whereas when the cells are tridimensional, three interpolants per node must be provided. `PhysicalDimension` becomes useful when expressing quantities such as the `InwardNormalList` in the `BC_t` data structure. It's possible to have a mesh where `IndexDimension` = 2 but the normal vectors still require x, y, z components in order to be properly defined. Consider, for example, a structured surface mesh in the 3D space.

Information about the number of time steps or iterations being recorded, and the time and/or iteration values at each step, may be contained in the `BaseIterativeData` structure.

Data specific to each zone in a multizone case is contained in the list of `Zone_t` structure entities.

Reference data applicable to the entire CGNS database is contained in the `ReferenceState` structure; quantities such as Reynolds number and freestream Mach number are contained here (for external flow problems).

`Axisymmetry` may be used to specify the axis of rotation and the circumferential extent for an axisymmetric database.

If a rotating coordinate system is being used, the rotation center and rotation rate vector may be specified using the `RotatingCoordinates` structure.

`Gravity` may be used to define the gravitational vector.

`SimulationType` is an enumeration type identifying the type of simulation. The default value is `SimulationTypeNull`.

```
SimulationType_t := Enumeration (
    SimulationTypeNull,
    SimulationTypeUserDefined,
    TimeAccurate,
    NonTimeAccurate ) ;
```

`DataClass` describes the global default for the class of data contained in the CGNS database. If the CGNS database contains dimensional data (e.g., velocity with units of m/s), `DimensionalUnits` may be used to describe the system of units employed.

`FlowEquationSet` contains a description of the governing flow equations associated with the entire CGNS database. This structure contains information on the general class of governing equations (e.g., Euler or Navier-Stokes), equation sets required for closure, including turbulence modeling and equations of state, and constants associated with the equations.

`DataClass`, `DimensionalUnits`, `ReferenceState` and `FlowEquationSet` have special function in the CGNS hierarchy. They are globally applicable throughout the database, but their precedence may be superseded by local entities (e.g., within a given zone). The scope of these entities and the rules for determining precedence are treated in [Section 6.4](#).

Globally relevant convergence history information is contained in `GlobalConvergenceHistory`. This convergence information includes total configuration forces, moments, and global residual and solution-change norms taken over all the zones.

Miscellaneous global data may be contained in the `IntegralData_t` list. Candidates for inclusion here are global forces and moments.

6.2.1 Base Level Families

The `Family_t` data structure, defined in [Section 12.6](#), is used to record geometry reference data. It may also include boundary conditions linked to geometry patches. For the purpose of defining material properties, families may also be defined for groups of elements.

The family-mesh association is defined under the `Zone_t`, the `ZoneSubRegion_t` and `BC_t` data structures by specifying the family name corresponding to a zone or a boundary patch. The familyname can refer to a `Family_t` defined in a `CGNSBase_t` other than the referring `Zone_t`, the `ZoneSubRegion_t` or `BC_t`. In this case, the actual name of the `Family_t` has to be prefixed by the `CGNSBase_t` name. The pattern is then `basename/familyname`, only one single / character is allowed, and neither of `basename` nor `familyname` should be empty.

The `UserDefinedData_t` data structure allows arbitrary user-defined data to be stored in `Descriptor_t` and `DataArray_t` children without the restrictions or implicit meanings imposed on these node types at other node locations.

6.3 Zone Structure Definition: `Zone_t`

The `Zone_t` structure contains all information pertinent to an individual zone. This information includes the zone type, the number of cells and vertices making up the grid in that zone, the physical coordinates of the grid vertices, grid motion information, the family, the flow solution, zone interface connectivity, boundary conditions, and zonal convergence history data. Zonal data may be recorded at multiple time steps or iterations. In addition, this structure contains a reference state, a set of flow equations and dimensional units that are all unique to the zone. For unstructured zones, the element connectivity may also be recorded.

```

ZoneType_t := Enumeration(
    ZoneTypeNull,
    ZoneTypeUserDefined,
    Structured,
    Unstructured ) ;

Zone_t< int CellDimension, int PhysicalDimension > :=
{
    List( Descriptor_t Descriptor1 ... DescriptorN ) ;           (o)

    ZoneType_t ZoneType ;                                       (r)

    int[IndexDimension] VertexSize ;                             (r)
    int[IndexDimension] CellSize ;                               (r)
    int[IndexDimension] VertexSizeBoundary ;                    (o/d)

    List( GridCoordinates_t<IndexDimension, VertexSize>
          GridCoordinates MovedGrid1 ... MovedGridN ) ;      (o)

    List( Elements_t Elements1 ... ElementsN ) ;               (o)

    List( RigidGridMotion_t RigidGridMotion1 ... RigidGridMotionN ) ; (o)

    List( ArbitraryGridMotion_t<IndexDimension, VertexSize, CellSize>

```

```
    ArbitraryGridMotion1 ... ArbitraryGridMotionN ) ;           (o)

    FamilyName_t FamilyName ;                                   (o)

    List( AdditionalFamilyName_t AddFamilyName1 ... AddFamilyNameN ) ; (o)

    List( FlowSolution_t<CellDimension, IndexDimension, VertexSize, CellSize>
          FlowSolution1 ... FlowSolutionN ) ;                   (o)

    List( DiscreteData_t<CellDimension, IndexDimension, VertexSize, CellSize>
          DiscreteData1 ... DiscreteDataN ) ;                   (o)

    List( IntegralData_t IntegralData1 ... IntegralDataN ) ;   (o)

    List( ZoneGridConnectivity_t<IndexDimension, CellDimension>
          ZoneGridConnectivity1 ... ZoneGridConnectivityN ) ;   (o)

    List( ZoneSubRegion_t<IndexDimension, VertexSize, CellSize>
          ZoneSubRegion1 ... ZoneSubRegion ) ;                   (o)

    ZoneBC_t<CellDimension, IndexDimension, PhysicalDimension> ZoneBC ; (o)

    ZoneIterativeData_t<NumberOfSteps> ZoneIterativeData ;     (o)

    ReferenceState_t ReferenceState ;                             (o)

    RotatingCoordinates_t RotatingCoordinates ;                 (o)

    DataClass_t DataClass ;                                       (o)

    DimensionalUnits_t DimensionalUnits ;                         (o)

    FlowEquationSet_t<CellDimension> FlowEquationSet ;           (o)

    ConvergenceHistory_t ZoneConvergenceHistory ;               (o)

    List( UserDefinedData_t UserDefinedData1 ... UserDefinedDataN ) ; (o)

    int Ordinal ;                                                 (o)
} ;
```

Notes

1. Default names for the Descriptor_t, Elements_t, RigidGridMotion_t, ArbitraryGridMotion_t, FlowSolution_t, DiscreteData_t, IntegralData_t, and UserDefinedData_t

lists are as shown; users may choose other legitimate names. Legitimate names must be unique within a given instance of `Zone_t` and shall not include the names `DataClass`, `DimensionalUnits`, `FamilyName`, `FlowEquationSet`, `GridCoordinates`, `Ordinal`, `ReferenceState`, `RotatingCoordinates`, `ZoneBC`, `ZoneConvergenceHistory`, `ZoneGridConnectivity`, `ZoneIterativeData`, or `ZoneType`.

2. The original grid coordinates should have the name `GridCoordinates`. Default names for the remaining entities in the `GridCoordinates_t` list are as shown; users may choose other legitimate names, subject to the restrictions listed in the previous note.
3. `ZoneType`, `VertexSize`, and `CellSize` are the only required fields within the `Zone_t` structure.

`Zone_t` requires the parameters `CellDimension` and `PhysicalDimension`. `CellDimension`, along with the type of zone, determines `IndexDimension`; if the zone type is `Unstructured`, `IndexDimension` = 1, and if the zone type is `Structured`, `IndexDimension` = `CellDimension`. These three structure parameters identify the dimensionality of the grid-size arrays. One or more of them are passed on to the grid coordinates, flow solution, interface connectivity, boundary condition and flow-equation description structures.

`VertexSize` is the number of vertices in each index direction, and `CellSize` is the number of cells in each direction. For example, for structured grids in 3-D, `CellSize` = `VertexSize` - [1,1,1], and for unstructured grids in 3-D, `CellSize` is simply the total number of 3-D cells. `VertexSize` is the number of vertices defining “the grid” or the domain (i.e., without rind points); `CellSize` is the number of cells on the interior of the domain. These two grid-size arrays are passed onto the grid-coordinate, flow-solution and discrete-data substructures.

If the nodes are sorted between internal nodes and boundary nodes, then the optional parameter `VertexSizeBoundary` must be set equal to the number of boundary nodes. If the nodes are sorted, the grid coordinate vector must first include the boundary nodes, followed by the internal nodes. By default, `VertexSizeBoundary` equals zero, meaning that the nodes are unsorted. This option is only useful for unstructured zones. For structured zones, `VertexSizeBoundary` always equals 0 in all index directions.

The `GridCoordinates_t` structure defines “the grid”; it contains the physical coordinates of the grid vertices, and may optionally contain physical coordinates of rind or ghost points. The original grid is contained in `GridCoordinates`. Additional `GridCoordinates_t` data structures are allowed, to store the grid at multiple time steps or iterations.

When the grid nodes are sorted, the `DataArray_t` in `GridCoordinates_t` lists first the data for the boundary nodes, then the data for the internal nodes.

The `Elements_t` data structure contains unstructured elements data such as connectivity, element type, parent elements, etc.

The `RigidGridMotion_t` and `ArbitraryGridMotion_t` data structures contain information defining rigid and arbitrary (i.e., deforming) grid motion.

`FamilyName` identifies to which family a zone belongs. Families may be used to define material properties. Where multiple families are desired, `AdditionalFamilyName` nodes may be used to specify them. Both `FamilyName` and `AdditionalFamilyName` should refer to a `CGNSBase_t` level `Family_t`, in the parent base of the zone or in another sibling base (see [Section 6.2.1](#)).

Flow-solution quantities are contained in the list of `FlowSolution_t` structures. Each instance of the `FlowSolution_t` structure is only allowed to contain data at a single grid location (vertices, cell-centers, etc.); multiple `FlowSolution_t` structures are provided to store flow-solution data at different grid locations, to record different solutions at the same grid location, or to store solutions at multiple time steps or iterations. These structures may optionally contain solution data defined at rind points.

Miscellaneous discrete field data is contained in the list of `DiscreteData_t` structures. Candidate information includes residuals, fluxes and other related discrete data that is considered auxiliary to the flow solution. Likewise, miscellaneous zone-specific global data, other than reference-state data and convergence history information, is contained in the list of `IntegralData_t` structures. It is envisioned that these structures will be seldom used in practice but are provided nonetheless.

The `ZoneSubRegion_t` node allows flowfield or other information to be specified over a subset of the entire zone.

For unstructured zones only, the node-based `DataArray_t` vectors (`GridLocation = Vertex`) in `FlowSolution_t` or `DiscreteData_t` must follow exactly the same ordering as the `GridCoordinates` vector. If the nodes are sorted (`VertexSizeBoundary \neq 0`), the data on the boundary nodes must be listed first, followed by the data on the internal nodes. Note that the order in which the node-based data are recorded must follow exactly the node ordering in `GridCoordinates_t`, to be able to associate the data to the correct nodes. For element-based data (`GridLocation = CellCenter`), the `FlowSolution_t` or `DiscreteData_t` data arrays must list the data values for each element, in the same order as the elements are listed in `ElementConnectivity`.

All interface connectivity information, including identification of overset-grid holes, for a given zone is contained in `ZoneGridConnectivity`.

All boundary condition information pertaining to a zone is contained in `ZoneBC_t`.

The `ZoneIterativeData_t` data structure may be used to record pointers to zonal data at multiple time steps or iterations.

Reference-state data specific to an individual zone is contained in the `ReferenceState` structure.

`RotatingCoordinates` may be used to specify the rotation center and rotation rate vector of a rotating coordinate system.

`DataClass` defines the zonal default for the class of data contained in the zone and its substructures. If a zone contains dimensional data, `DimensionalUnits` may be used to describe the system of dimensional units employed.

If a set of flow equations are specific to a given zone, these may be described in `FlowEquationSet`. For example, if a single zone within the domain is inviscid, whereas all other are turbulent, then this zone-specific equation set could be used to describe the special zone.

`DataClass`, `DimensionalUnits`, `ReferenceState` and `FlowEquationSet` have special function in the hierarchy. They are applicable throughout a given zone, but their precedence may be superseded by local entities contained in the zone's substructures. If any of these entities are present within a given instance of `Zone_t`, they take precedence over the corresponding global entities contained in database's `CGNSBase_t` entity. These precedence rules are further discussed in [Section 6.4](#).

Convergence history information applicable to the zone is contained in `ZoneConvergenceHistory`; this includes residual and solution-change norms.

The `UserDefinedData_t` data structure allows arbitrary user-defined data to be stored in `Descriptor_t` and `DataArray_t` children without the restrictions or implicit meanings imposed on these node types at other node locations.

`Ordinal` is user-defined and has no restrictions on the values that it can contain. It is included for backward compatibility to assist implementation of the CGNS system into applications whose I/O depends heavily on the numbering of zones. Since there are no restrictions on the values contained in `Ordinal` (or that `Ordinal` is even provided), there is no guarantee that the zones in an existing CGNS database will have sequential values from 1 to N without holes or repetitions. Use of `Ordinal` is discouraged and is on a user-beware basis.

6.4 Precedence Rules and Scope Within the Hierarchy

6.4.1 Single Base

The dependence of a structure entity's information on data contained at higher levels of the hierarchy is typically explicitly expressed through structure parameters. For example, all arrays within `Zone_t` depend on the dimensionality of the computational grid. This dimensionality is passed down to a `Zone_t` entity through a structure parameter in the definition of `Zone_t`.

We have established an alternate dependency for a limited number of entities that is not explicitly stated in the structure type definitions. These special situations include entities for describing data class, system of dimensional units, reference states and flow equation sets. At each level of the hierarchy (where appropriate), entities for describing this information are defined, and if present they take precedence over all corresponding information existing at higher levels of the CGNS hierarchy. Essentially, we have established globally applicable data with provisions for recursively overriding it with local data.

Specifically, the entities that follow this alternate dependency are:

- `FlowEquationSet_t` `FlowEquationSet`,
- `ReferenceState_t` `ReferenceState`,
- `DataClass_t` `DataClass`,
- `DimensionalUnits_t` `DimensionalUnits`.

`FlowEquationSet` contains a description of the governing flow equations (see [Section 10](#)); `ReferenceState` describes a set of reference state flow conditions (see [Section 12.1](#)); `DataClass` defines the class of data (e.g., dimensional or nondimensional—see [Section 4.1](#) and [Section 5](#)); and `DimensionalUnits` specifies the system of units used for dimensional data (see [Section 4.3](#)).

All of these entities may be defined within the highest level `CGNSBase_t` structure, and if present in a given database, establish globally applicable information; these may also be considered to be global defaults. Each of these four entities may also be defined within the `Zone_t` structure. If

present in a given instance of `Zone_t`, they supersede the global data and establish new defaults that apply only within that zone.

For example, if a different set of flow equations is solved within a given zone than is solved in the rest of the flowfield, then this can be conveyed through `FlowEquationSet`. In this case, one `FlowEquationSet` entity would be placed within `CGNSBase_t` to state the globally applicable flow equations, and a second `FlowEquationSet` entity would be placed within the given zone (within its instance of `Zone_t`); this second `FlowEquationSet` entity supersedes the first only within the given zone.

In addition to its presence in `CGNSBase_t` and `Zone_t`, `ReferenceState` may also be defined within the boundary-condition structure types to establish reference states applicable to one or more boundary-condition patches. Actually, `ReferenceState` entities can be defined at several levels of the boundary-condition hierarchy to allow flexibility in setting the appropriate reference state conditions (see [Section 9.1](#) and subsequent sections).

`DataClass` and `DimensionalUnits` are used within entities describing data arrays (see the `DataArray_t` type definition in [Section 5.1](#)). They classify the data and specify its system of units if dimensional. If these entities are absent from a particular instance of `DataArray_t`, the information is derived from appropriate global data. `DataClass` and `DimensionalUnits` are also declared in all intermediate structure types that directly or indirectly contain `DataArray_t` entities. Examples include `GridCoordinates_t` ([Section 7.1](#)), `FlowSolution_t` ([Section 7.7](#)), `BC_t` ([Section 9.3](#)) and `ReferenceState_t` ([Section 12.1](#)). The same precedence rules apply—lower-level entities supersede higher-level entities.

It is envisioned that in practice, the use of globally applicable data will be the norm rather than the exception. It provides a measure of economy throughout the CGNS database in many situations. For example, when creating a database where the vast majority of data arrays are dimensional and use a consistent set of units, `DataClass` and `DimensionalUnits` can be set appropriately at the `CGNSBase_t` level and thereafter omitted when outputting data.

6.4.2 Multiple Bases

With a multiple-bases CGNS tree, some nodes defined at the base level may lead to an inconsistent CGNS set of data. In that case it is up to the application using the CGNS tree to define its own understanding of the data. In particular, the following nodes are not required to be the same in all bases of a CGNS tree, thus inter-base references may lead to inconsistency:

- `CellDimension` and `PhysicalDimension`
- `ReferenceState`
- `Axisymmetry`
- `RotatingCoordinates`
- `Gravity`
- `SimulationType`

- DataClass
- DimensionalUnits
- FlowEquationSet
- Family_t

The application has to take into account the corresponding base definition for the referred-to node.

7 Grid Coordinates, Elements, and Flow Solutions

This section defines structure types for describing the grid coordinates, element data, and flow solution data pertaining to a zone. Entities of each of the structure types defined in this section are contained in the `Zone_t` structure (see [Section 6.3](#)).

7.1 Grid Coordinates Structure Definition: `GridCoordinates_t`

The physical coordinates of the grid vertices are described by the `GridCoordinates_t` structure. This structure contains a list for the data arrays of the individual components of the position vector. It also provides a mechanism for identifying rind-point data included within the position-vector arrays.

```
GridCoordinates_t< int IndexDimension, int VertexSize[IndexDimension] > :=
{
  List( Descriptor_t Descriptor1 ... DescriptorN ) ;           (o)

  Rind_t<IndexDimension> Rind ;                               (o/d)

  List( DataArray_t<DataType, IndexDimension, DataSize[]>
        DataArray1 ... DataArrayN ) ;                       (o)

  DataClass_t DataClass ;                                   (o)

  DimensionalUnits_t DimensionalUnits ;                     (o)

  List( UserDefinedData_t UserDefinedData1 ... UserDefinedDataN ) ; (o)
} ;
```

Notes

1. Default names for the `Descriptor_t`, `DataArray_t`, and `UserDefinedData_t` lists are as shown; users may choose other legitimate names. Legitimate names must be unique within a given instance of `GridCoordinates_t` and shall not include the names `DataClass`, `DimensionalUnits`, or `Rind`.
2. There are no required fields for `GridCoordinates_t`. `Rind` has a default if absent; the default is equivalent to having a `Rind` structure whose `RindPlanes` array contains all zeros (see [Section 4.8](#)).
3. The structure parameter `DataType` must be consistent with the data stored in the `DataArray_t` substructures (see [Section 5.1](#)).

`GridCoordinates_t` requires two structure parameters: `IndexDimension` identifies the dimensionality of the grid-size arrays, and `VertexSize` is the number of vertices in each index direction excluding rind points. For unstructured zones, `IndexDimension` is always 1 and `VertexSize` is the total number of vertices, excluding rind points.

The grid-coordinates data is stored in the list of `DataArray_t` entities; each `DataArray_t` structure entity may contain a single component of the position vector (e.g., three separate `DataArray_t` entities are used for x , y , and z). Standardized data-name identifiers for the grid coordinates are described in [Appendix A](#).

`Rind` is an optional field that indicates the number of rind planes (for structured grids) or rind points or elements (for unstructured grids) included in the grid-coordinates data. If `Rind` is absent, then the `DataArray_t` structure entities contain only “core” vertices of a zone; core refers to all interior and bounding vertices of a zone — `VertexSize` is the number of core vertices. Core vertices in a zone are assumed to begin at `[1,1,1]` (for a structured zone in 3-D) and end at `VertexSize`. If `Rind` is present, it will provide information on the number of “rind” points in addition to the core points that are contained in the `DataArray_t` structures.

`DataClass` defines the default class for data contained in the `DataArray_t` entities. For dimensional grid coordinates, `DimensionalUnits` may be used to describe the system of units employed. If present, these two entities take precedence over the corresponding entities at higher levels of the CGNS hierarchy. The rules for determining precedence of entities of this type are discussed in [Section 6.4](#). An example that uses these grid-coordinate defaults is shown in [Section 7.2](#).

The `UserDefinedData_t` data structure allows arbitrary user-defined data to be stored in `Descriptor_t` and `DataArray_t` children without the restrictions or implicit meanings imposed on these node types at other node locations.

FUNCTION `DataSize[]`:

return value: one-dimensional `int` array of length `IndexDimension`

dependencies: `IndexDimension`, `VertexSize[]`, `Rind`

`GridCoordinates_t` requires a single structure function, named `DataSize`, to identify the array sizes of the grid-coordinates data. A function is required for the following reasons:

- the entire grid, including both core and rind points, is stored in the `DataArray_t` entities;
- the `DataArray_t` structure is simple in that it doesn’t know anything about core versus rind data; it just knows that it contains data of some given size;
- to make all the `DataArray_t` entities syntactically consistent in their size (i.e., by syntax entities containing x , y and z must have the same dimensionality and dimension sizes), the size of the array is passed onto the `DataArray_t` structure as a parameter.

```
if (Rind is absent) then
{
  DataSize[] = VertexSize[] ;
}
else if (Rind is present) then
{
  DataSize[] = VertexSize[] + [a + b,...] ;
}
```

where `RindPlanes = [a,b,...]` (see [Section 4.8](#) for the definition of `RindPlanes`).

7.2 Grid Coordinates Examples

This section contains examples of grid coordinates. These examples show the storage of the grid-coordinate data arrays, as well as different mechanisms for describing the class of data and the system of units or normalization.

Example 7-A: Cartesian Coordinates for a 2-D Structured Grid

This example uses Cartesian coordinates for a 2-D grid of size 17×33 ; the data arrays include only core vertices, and the coordinates are in units of feet.

```

! IndexDimension = 2
! VertexSize = [17,33]
GridCoordinates_t<2, [17,33]> GridCoordinates =
  {{
  DataArray_t<real, 2, [17,33]> CoordinateX =
    {{
    Data(real, 2, [17,33]) = ((x(i,j), i=1,17), j=1,33) ;

    DataClass_t DataClass = Dimensional ;

    DimensionalUnits_t DimensionalUnits =
      {{
      MassUnits          = MassUnitsNull ;
      LengthUnits        = Foot ;
      TimeUnits           = TimeUnitsNull ;
      TemperatureUnits   = TemperatureUnitsNull ;
      AngleUnits          = AngleUnitsNull ;
      }} ;
    }} ;

  DataArray_t<real, 2, [17,33]> CoordinateY =
    {{
    Data(real, 2, [17,33]) = ((y(i,j), i=1,17), j=1,33) ;

    DataClass_t DataClass = Dimensional ;

    DimensionalUnits_t DimensionalUnits =
      {{
      MassUnits          = MassUnitsNull ;
      LengthUnits        = Foot ;
      TimeUnits           = TimeUnitsNull ;
      TemperatureUnits   = TemperatureUnitsNull ;
      AngleUnits          = AngleUnitsNull ;
      }} ;
    }} ;
  }} ;

```

From [Appendix A](#), the identifiers for x and y are `CoordinateX` and `CoordinateY`, respectively, and both have a data type of `real`. The value of `DataClass` in `CoordinateX` and `CoordinateY` indicate the data is dimensional, and `DimensionalUnits` specifies the appropriate units are feet. The `DimensionalExponents` entity is absent from both `CoordinateX` and `CoordinateY`; the information that x and y are lengths can be inferred from the data-name identifier conventions in [Section A.1](#).

Note that FORTRAN multidimensional array indexing is used to store the data; this is reflected in the FORTRAN-like implied do-loops for $x(i,j)$ and $y(i,j)$.

Because the dimensional units for both x and y are the same, an alternate approach is to set the data class and system of units using `DataClass` and `DimensionalUnits` at the `GridCoordinates_t` level, and eliminate this information from each instance of `DataArray_t`.

```
GridCoordinates_t<2, [17,33]> GridCoordinates =
  {{
    DataClass_t DataClass = Dimensional ;

    DimensionalUnits_t DimensionalUnits =
      {{
        MassUnits          = MassUnitsNull ;
        LengthUnits        = Foot ;
        TimeUnits           = TimeUnitsNull ;
        TemperatureUnits    = TemperatureUnitsNull ;
        AngleUnits          = AngleUnitsNull ;
      }} ;

    DataArray_t<real, 2, [17,33]> CoordinateX =
      {{
        Data(real, 2, [17,33]) = ((x(i,j), i=1,17), j=1,33) ;
      }} ;

    DataArray_t<real, 2, [17,33]> CoordinateY =
      {{
        Data(real, 2, [17,33]) = ((y(i,j), i=1,17), j=1,33) ;
      }} ;
  }} ;
```

Since the `DataClass` and `DimensionalUnits` entities are not present in `CoordinateX` and `CoordinateY`, the rules established in [Section 5.2.1](#) dictate that `DataClass` and `DimensionalUnits` specified at the `GridCoordinates_t` level be used to retrieve the information.

Example 7-B: Cylindrical Coordinates for a 3-D Structured Grid

This example uses cylindrical coordinates for a 3-D grid whose core size is $17 \times 33 \times 9$; the grid contains a single plane of rind on the minimum and maximum k faces. The coordinates are nondimensional.

```

! IndexDimension = 3
! VertexSize = [17,33,9]
GridCoordinates_t<3, [17,33,9]> GridCoordinates =
  {{
  Rind_t<3> Rind =
    {{
    int[6] RindPlanes = [0,0,0,0,1,1] ;
    }} ;

! DataType = real
! IndexDimension = 3
! DataSize = VertexSize + [0,0,2] = [17,33,11]
DataArray_t<real, 3, [17,33,11]> CoordinateRadius =
  {{
  Data(real, 3, [17,33,11]) = (((r(i,j,k), i=1,17), j=1,33), k=0,10) ;

  DataClass_t DataClass = NormalizedByUnknownDimensional ;
  }} ;

DataArray_t<real, 3, [17,33,11]> CoordinateZ      = {{ }} ;
DataArray_t<real, 3, [17,33,11]> CoordinateTheta = {{ }} ;
}} ;

```

The value of `RindPlanes` specifies two rind planes on the minimum and maximum k faces. These rind planes are reflected in the structure function `DataSize` which is equal to the number of core vertices plus two in the k dimension. The value of `DataSize` is passed to the `DataArray_t` entities. The value of `DataClass` indicates the data is nondimensional. Note that if `DataClass` is set as `NormalizedByUnknownDimensional` at a higher level (`CGNSBase_t` or `Zone_t`), then it is not needed here.

Note that the entities `CoordinateZ` and `CoordinateTheta` are abbreviated.

Example 7-C: Cartesian Coordinates for a 3-D Unstructured Grid

This example uses Cartesian grid coordinates for a 3-D unstructured zone where `VertexSize` is 15.

```

GridCoordinates_t<1, 15> GridCoordinates =
  {{

! DataType = real
! IndexDimension = 1

```

```
! DataSize = VertexSize = 15
DataArray_t<real, 1, 15> CoordinateX =
  {{
    Data(real, 1, 15) = (x(i), i=1,15) ;
  }} ;

DataArray_t<real, 1, 15> CoordinateY =
  {{
    Data(real, 1, 15) = (y(i), i=1,15) ;
  }} ;

DataArray_t<real, 1, 15> CoordinateZ =
  {{
    Data(real, 1, 15) = (z(i), i=1,15) ;
  }} ;
}}
```

7.3 Elements Structure Definition: Elements_t

The Elements_t data structure is required for unstructured zones, and contains the element connectivity data, the element type, the element range, the parent elements data, and the number of boundary elements.

```
Elements_t :=
{
  List( Descriptor_t Descriptor1 ... DescriptorN ) ;           (o)

  Rind_t<IndexDimension> Rind ;                               (o/d)

  IndexRange_t ElementRange ;                                (r)

  int ElementSizeBoundary ;                                  (o/d)

  ElementType_t ElementType ;                                (r)

  DataArray_t<int, 1, ElementDataSize> ElementConnectivity ; (r)

  DataArray_t<int, 2, [ElementSize, 2]> ParentElements ;     (o)
  DataArray_t<int, 2, [ElementSize, 2]> ParentElementsPosition ; (o)

  List( UserDefinedData_t UserDefinedData1 ... UserDefinedDataN ) ; (o)
} ;
```

Notes

1. Default names for the `Descriptor_t` and `UserDefinedData_t` lists are as shown; users may choose other legitimate names. Legitimate names must be unique within a given instance of `Elements_t` and shall not include the names `ElementConnectivity`, `ElementRange`, `ParentElements`, `ParentElementsPosition`, or `Rind`.
2. `IndexRange_t`, `ElementType_t`, and `ElementConnectivity_t` are the required fields within the `Elements_t` structure. `Rind` has a default if absent; the default is equivalent to having a `Rind` structure whose `RindPlanes` array contains all zeros (see [Section 4.8](#)).

`Rind` is an optional field that indicates the number of rind elements included in the elements data. If `Rind` is absent, then the `DataArray_t` structure entities contain only core elements of a zone. If `Rind` is present, it will provide information on the number of rind elements, in addition to the core elements, that are contained in the `DataArray_t` structures.

Note that the usage of rind data with respect to the size of the `DataArray_t` structures is different under `Elements_t` than elsewhere. For example, when rind coordinate data is stored under `GridCoordinates_t`, the parameter `VertexSize` accounts for the core data only. The size of the `DataArray_t` structures containing the grid coordinates is determined by the `DataSize` function, which adds the number of rind planes or points to `VertexSize`. But for the element connectivity, the size of the `DataArray_t` structures containing the connectivity data is just `ElementDataSize`, which depends on `ElementSize`, and includes both the core and rind elements.

`ElementRange` contains the index of the first and last elements defined in `ElementConnectivity`. The elements are indexed with a global numbering system, starting at 1, for all element sections under a given `Zone_t` data structure. The global numbering insures that each element, whether it's a cell, a face, or an edge, is uniquely identified by its number. They are also listed as a continuous list of element numbers within any single element section. Therefore the number of elements in a section is:

$$\text{ElementSize} = \text{ElementRange.end} - \text{ElementRange.start} + 1$$

The element indices are used for the boundary condition and zone connectivity definition.

`ElementSizeBoundary` indicates if the elements are sorted, and how many boundary elements are recorded. By default, `ElementSizeBoundary` is set to zero, indicating that the elements are not sorted. If the elements are sorted, `ElementSizeBoundary` is set to the number of elements at the boundary. Consequently:

$$\text{ElementSizeInterior} = \text{ElementSize} - \text{ElementSizeBoundary}$$

`ElementType_t` is an enumeration of the supported element types:

```
ElementType_t := Enumeration(  
    ElementTypeNull, ElementTypeUserDefined, NODE, BAR_2, BAR_3,  
    TRI_3, TRI_6, QUAD_4, QUAD_8, QUAD_9,  
    TETRA_4, TETRA_10, PYRA_5, PYRA_14,
```

```
PENTA_6, PENTA_15, PENTA_18, HEXA_8, HEXA_20, HEXA_27,  
MIXED, PYRA_13, NGON_n, NFACE_n,  
BAR_4, TRI_9, TRI_10, QUAD_12, QUAD_16,  
TETRA_16, TETRA_20, PYRA_21, PYRA_29, PYRA_30,  
PENTA_24, PENTA_38, PENTA_40, HEXA_32, HEXA_56, HEXA_64 );
```

Section 3.3 illustrates the convention for element numbering.

For all element types except MIXED, NGON_n, and NFACE_n, `ElementConnectivity` contains the list of nodes for each element. If the elements are sorted, then it must first list the connectivity of the boundary elements, then that of the interior elements.

```
ElementConnectivity = Node11, Node21, ... NodeN1,  
                    Node12, Node22, ... NodeN2,  
                    ...  
                    Node1M, Node2M, ... NodeNM
```

where M is the total number of elements (i.e., `ElementSize`), and N is the number of nodes per element.

`ElementDataSize` indicates the total size (number of integers) of the array `ElementConnectivity`. For all element types except MIXED, NGON_n, and NFACE_n, the `ElementDataSize` is given by:

```
ElementDataSize = ElementSize * NPE[ElementType]
```

where `NPE[ElementType]` is a function returning the number of nodes for the given `ElementType`. For example, `NPE[HEXA_8]=8`.

When the section `ElementType` is MIXED, the data array `ElementConnectivity` contains one extra integer per element, to hold each individual element type:

```
ElementConnectivity = Etype1, Node11, Node21, ... NodeN1,  
                    Etype2, Node12, Node22, ... NodeN2,  
                    ...  
                    EtypeM, Node1M, Node2M, ... NodeNM
```

where again M is the total number of elements, and N_i is the number of nodes in element i . In the case of MIXED element section, `ElementDataSize` is given by:

$$\text{ElementDataSize} = \sum_{n=\text{start}}^{\text{end}} (\text{NPE}[\text{ElementType}_n] + 1)$$

Arbitrary polyhedral elements may be defined using the NGON_n and NFACE_n element types. The NGON_n element type is used to specify all the faces in the grid, and the NFACE_n element type is then used to define the polyhedral elements as a collection of these faces. Except for boundary faces, each face of a polyhedral element must be shared by another polyhedral element.

For example, for `NGON_n`, the data array `ElementConnectivity` contains a list of nodes making up each face in the grid, with the first value for each face defining the number of nodes making up that face:

```
ElementConnectivity = Nnodes1, Node11, Node21, ... NodeN1,
                    Nnodes2, Node12, Node22, ... NodeN2,
                    ...
                    NnodesM, Node1M, Node2M, ... NodeNM
```

where here M is the total number of faces, and N_i is the number of nodes in face i . The `ElementDataSize` is the total number of nodes defining all the faces, plus one value per face specifying the number of nodes making up that face.

Then for `NFACE_n`, `ElementConnectivity` contains the list of face elements making up each polyhedral element, with the first value for each polyhedra defining the number of faces making up that polyhedral element.

```
ElementConnectivity = Nfaces1, Face11, Face21, ... FaceN1,
                    Nfaces2, Face12, Face22, ... FaceN2,
                    ...
                    NfacesM, Face1M, Face2M, ... FaceNM
```

where now M is the total number of polyhedral elements, and N_i is the number of faces in element i . The sign of the face number determines its orientation (i.e., the direction of the face normal, constructed as defined by the convention for 2-D elements in [Section 3.3.2](#)). If the face number is positive, the face normal is directed outward; if it's negative, the face normal is directed inward. The `ElementDataSize` is the sum of the number of faces defining each polyhedral element, plus one value per polyhedral element specifying the number of faces making up that element.

For face elements in 3-D, or bar element in 2-D, additional data may be provided for each element in `ParentElements` and `ParentElementsPosition`. The element numbers of the two adjacent cells for each face are given in `ParentElements`. The corresponding canonical positions of the face in the two parent cells is given in `ParentElementsPosition`; these canonical face positions are defined in [Section 3.3](#). For faces on the boundary of the domain, the second parent is set to zero.

The `UserDefinedData_t` data structure allows arbitrary user-defined data to be stored in `Descriptor_t` and `DataArray_t` children without the restrictions or implicit meanings imposed on these node types at other node locations.

7.4 Elements Examples

This section contains four examples of elements definition in CGNS. The first example is for a simple three-element tetrahedral grid, using the `TETRA_4` element type. The second example is for the same grid as the first example, but the elements are treated as general polyhedra to illustrate the use of the `NGON_n` and `NFACE_n` element types. The third and fourth examples are for an unstructured zone with 15 tetrahedral and 10 hexahedral elements, with the third example defining the elements

in separate sections for the TETRA_4 and HEXA_8 element types, and the fourth example combining them using the MIXED element type.

Example 7-D: TETRA_4 Element Types

This example uses the simple three-element tetrahedral grid shown in Figure 4.

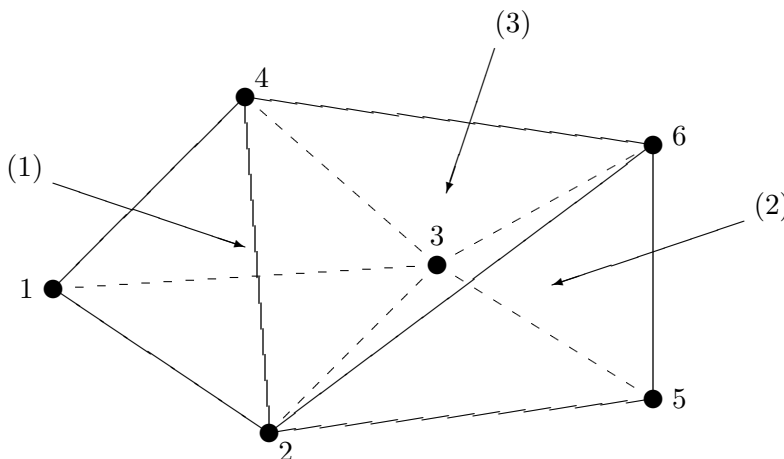

Figure 4: Example Tetrahedral Grid

The element type is TETRA_4, and the connectivity is defined in `ElementConnectivity` by specifying the four nodes comprising each element, with the order consistent with the numbering conventions for tetrahedral elements. The data in `ElementConnectivity` is grouped by element; note that the parentheses are added here for presentation purposes only.

```
Zone_t UnstructuredZone =
  {{
  Elements_t TetraElements =
    {{
    IndexRange_t ElementRange = [1,3] ;

    ElementType_t ElementType = TETRA_4 ;

    DataArray_t<int, 1, NPE[TETRA_4]×3> ElementConnectivity =
      {{
      Data(int, 1, NPE[TETRA_4]×3) =
        (1, 2, 3, 4), (2, 5, 3, 6), (2, 6, 3, 4) ;
      }} ;
    }} ;
  }} ;
```

Example 7-E: NGON_n and NFACE_n Element Types

This example uses the same grid as in the previous example, but treats the elements as general polyhedra to illustrate the use of the `NGON_n` and `NFACE_n` element types. The grid consists of three volume elements, each made up of four face elements, with each face defined by three nodes.

For each face, the nodes comprising that face are listed in `ElementConnectivity` for the `NGON_n` element type. The `ElementRange` is `[1,10]`, corresponding to the 10 total faces. The `ElementDataSize` is 40, corresponding to the total of 30 nodes defining the 10 faces, plus one value per face specifying the number of nodes making up that face.

The faces making up the three volume elements are then listed in `ElementConnectivity` for the `NFACE_n` element type. The `ElementRange` is `[11,13]`, corresponding to the three volume elements. The `ElementDataSize` is 15, corresponding to three volume elements with four faces per element, plus one value per volume element specifying the number of faces making up that element. Note that the face numbers for faces 3 and 8 are negative in the definition of volume element 3, since their normals point inward for that element. Again, the parentheses in `ElementConnectivity` are for presentation purposes only.

```
Zone_t UnstructuredZone =
  {{
  Elements_t NgonElements =
    {{
    IndexRange_t ElementRange = [1,10] ;

    ElementType_t ElementType = NGON_n ;

    DataArray_t<int, 1, 40> ElementConnectivity =
      {{
      Data(int, 1, 40) =
        (3, 1, 3, 2), (3, 1, 2, 4), (3, 2, 3, 4), (3, 3, 1, 4),
        (3, 2, 3, 5), (3, 2, 5, 6), (3, 5, 3, 6), (3, 3, 2, 6),
        (3, 2, 6, 4), (3, 6, 3, 4) ;
      }} ;
    }} ;
  Elements_t NfaceElements =
    {{
    IndexRange_t ElementRange = [11,13] ;

    ElementType_t ElementType = NFACE_n ;

    DataArray_t<int, 1, 15> ElementConnectivity =
      {{
      Data(int, 1, 15) =
        (4, 1, 2, 3, 4),
        (4, 5, 6, 7, 8),
        (4, -8, 9, 10, -3) ;
      }} ;
  }} ;
```

```
    }} ;  
}} ;
```

Example 7-F: Separate Element Types

In this example, elements are defined for an unstructured zone with 15 tetrahedral and 10 hexahedral elements. The elements are written in two separate sections, one for the tetrahedral elements and one for the hexahedral elements.

```
Zone_t UnstructuredZone =  
  {{  
    Elements_t TetraElements =  
      {{  
        IndexRange_t ElementRange = [1,15] ;  
  
        int ElementSizeBoundary = 10 ;  
  
        ElementType_t ElementType = TETRA_4 ;  
  
        DataArray_t<int, 1, NPE[TETRA_4]×15> ElementConnectivity =  
          {{  
            Data(int, 1, NPE[TETRA_4]×15) = (node(i,j), i=1,NPE[TETRA_4], j=1,15) ;  
          }} ;  
      }} ;  
    Elements_t HexaElements =  
      {{  
        IndexRange_t ElementRange = [16,25] ;  
  
        int ElementSizeBoundary = 0 ;  
  
        ElementType_t ElementType = HEXA_8 ;  
  
        DataArray_t<int, 1, NPE[HEXA_8]×10> ElementConnectivity =  
          {{  
            Data(int, 1, NPE[HEXA_8]×10) = (node(i,j), i=1,NPE[HEXA_8], j=1,10) ;  
          }} ;  
      }} ;  
  }} ;
```

Example 7-G: MIXED Element Type

In this example, the same unstructured zone described in [Example 7-F](#) is written in a single element section of type MIXED (i.e., an unstructured grid composed of mixed elements).

```
Zone_t UnstructuredZone =  
  {{
```



```

Elements_t MixedElementsSection =
  {{
    IndexRange_t ElementRange = [1,25] ;

    ElementType_t ElementType = MIXED ;

    DataArray_t<int, 1, ElementDataSize> ElementConnectivity =
      {{
        Data(int, 1, ElementDataSize) = (etype(j), (node(i,j),
          i=1,NPE[etype(j)]), j=1,25) ;
      }} ;
  }} ;
}} ;

```

7.5 Axisymmetry Structure Definition: Axisymmetry_t

The `Axisymmetry_t` data structure allows recording the axis of rotation and the angle of rotation around this axis for a two-dimensional dataset that represents an axisymmetric database.

```

Axisymmetry_t :=
  {
    List( Descriptor_t Descriptor1 ... DescriptorN ) ;           (o)

    DataArray_t<real,1,2> AxisymmetryReferencePoint ;          (r)
    DataArray_t<real,1,2> AxisymmetryAxisVector ;              (r)
    DataArray_t<real,1,1> AxisymmetryAngle ;                   (o)
    DataArray_t<char,2,[32,2]> CoordinateNames ;                (o)

    DataClass_t DataClass ;                                     (o)

    DimensionalUnits_t DimensionalUnits ;                       (o)

    List( UserDefinedData_t UserDefinedData1 ... UserDefinedDataN ) ; (o)
  } ;

```

Notes

1. Default names for the `Descriptor_t` and `UserDefinedData_t` lists are as shown; users may choose other legitimate names. Legitimate names must be unique within a given instance of `Axisymmetry_t` and shall not include the names `AxisymmetryAngle`, `AxisymmetryAxisVector`, `AxisymmetryReferencePoint`, `CoordinateNames`, `DataClass`, or `DimensionalUnits`.
2. `AxisymmetryReferencePoint` and `AxisymmetryAxisVector` are the required fields within the `Axisymmetry_t` structure.

`AxisymmetryReferencePoint` specifies the origin used for defining the axis of rotation.

`AxisymmetryAxisVector` contains the direction cosines of the axis of rotation, through the `AxisymmetryReferencePoint`. For example, for a 2-D dataset defined in the (x, y) plane, if `AxisymmetryReferencePoint` contains $(0, 0)$ and `AxisymmetryAxisVector` contains $(1, 0)$, the x -axis is the axis of rotation.

`AxisymmetryAngle` allows specification of the circumferential extent about the axis of rotation. If this angle is undefined, it is assumed to be 360° .

`CoordinateNames` may be used to specify the first and second coordinates used in the definition of `AxisymmetryReferencePoint` and `AxisymmetryAxisVector`. If not found, it is assumed that the first coordinate is `CoordinateX` and the second is `CoordinateY`. The coordinates given under `CoordinateNames`, or implied by using the default, must correspond to those found under `GridCoordinates_t`.

`DataClass` defines the default class for numerical data contained in the `DataArray_t` entities. For dimensional data, `DimensionalUnits` may be used to describe the system of units employed. If present, these two entities take precedence over the corresponding entities at higher levels of the CGNS hierarchy, following the standard precedence rules.

The `UserDefinedData_t` data structure allows arbitrary user-defined data to be stored in `Descriptor_t` and `DataArray_t` children without the restrictions or implicit meanings imposed on these node types at other node locations.

7.6 Rotating Coordinates Structure Definition: `RotatingCoordinates_t`

The `RotatingCoordinates_t` data structure is used to record the rotation center and rotation rate vector of a rotating coordinate system.

```
RotatingCoordinates_t :=  
  {  
    List( Descriptor_t Descriptor1 ... DescriptorN ) ;           (o)  
  
    DataArray_t<real,1,PhysicalDimension> RotationCenter ;     (r)  
    DataArray_t<real,1,PhysicalDimension> RotationRateVector ; (r)  
  
    DataClass_t DataClass ;                                     (o)  
  
    DimensionalUnits_t DimensionalUnits ;                     (o)  
  
    List( UserDefinedData_t UserDefinedData1 ... UserDefinedDataN ) ; (o)  
  } ;
```

Notes

1. Default names for the `Descriptor_t` and `UserDefinedData_t` lists are as shown; users may choose other legitimate names. Legitimate names must be unique within a given instance

of `RotatingCoordinates_t` and shall not include the names `DataClass`, `DimensionalUnits`, `RotationCenter`, or `RotationRateVector`.

2. `RotationCenter` and `RotationRateVector` are the required fields within the `RotatingCoordinates_t` structure.

`RotationCenter` specifies the coordinates of the center of rotation, and `RotationRateVector` specifies the components of the angular velocity of the grid about the center of rotation. Together, they define the angular velocity vector. The direction of the angular velocity vector specifies the axis of rotation, and its magnitude specifies the rate of rotation.

For example, for the common situation of rotation about the x -axis, `RotationCenter` would be specified as any point on the x -axis, like $(0, 0, 0)$. `RotationRateVector` would then be specified as $(\omega, 0, 0)$, where ω is the rotation rate. Using the right-hand rule, ω would be positive for clockwise rotation (looking in the $+x$ direction), and negative for counter-clockwise rotation.

Note that for a rotating coordinate system, the axis of rotation is defined in the inertial frame of reference, while the grid coordinates stored using the `GridCoordinates_t` data structure are relative to the rotating frame of reference.

`DataClass` defines the default class for data contained in the `DataArray_t` entities. For dimensional data, `DimensionalUnits` may be used to describe the system of units employed. If present, these two entities take precedence over the corresponding entities at higher levels of the CGNS hierarchy, following the standard precedence rules.

The `UserDefinedData_t` data structure allows arbitrary user-defined data to be stored in `Descriptor_t` and `DataArray_t` children without the restrictions or implicit meanings imposed on these node types at other node locations.

If rotating coordinates are used, it is useful to store variables relative to the rotating frame. Standardized data-name identifiers should be used for these variables, as defined for flow-solution quantities in [Appendix A](#).

7.7 Flow Solution Structure Definition: `FlowSolution_t`

The flow solution within a given zone is described by the `FlowSolution_t` structure. This structure contains a list for the data arrays of the individual flow-solution variables, as well as identifying the grid location of the solution. It also provides a mechanism for identifying rind-point data included within the data arrays.

```
FlowSolution_t< int CellDimension, int IndexDimension,
               int VertexSize[IndexDimension],
               int CellSize[IndexDimension] > :=
{
  List( Descriptor_t Descriptor1 ... DescriptorN ) ;           (o)
  GridLocation_t GridLocation ;                               (o/d)
  Rind_t<IndexDimension> Rind ;                               (o/d)
```

```
IndexRange_t<IndexDimension> PointRange ; (o)
IndexArray_t<IndexDimension, ListLength[], int> PointList ; (o)

List( DataArray_t<DataType, IndexDimension, DataSize[]>
      DataArray1 ... DataArrayN ) ; (o)

DataClass_t DataClass ; (o)

DimensionalUnits_t DimensionalUnits ; (o)

List( UserDefinedData_t UserDefinedData1 ... UserDefinedDataN ) ; (o)
} ;
```

Notes

1. Default names for the `Descriptor_t`, `DataArray_t`, and `UserDefinedData_t` lists are as shown; users may choose other legitimate names. Legitimate names must be unique within a given instance of `FlowSolution_t` and shall not include the names `DataClass`, `DimensionalUnits`, `GridLocation`, `PointList`, `PointRange`, or `Rind`.
2. There are no required fields for `FlowSolution_t`. `GridLocation` has a default of `Vertex` if absent. `Rind` also has a default if absent; the default is equivalent to having an instance of `Rind` whose `RindPlanes` array contains all zeros (see [Section 4.8](#)).
3. Both of the fields `PointList` and `PointRange` are optional. Only one of these two fields may be specified.
4. The structure parameter `DataType` must be consistent with the data stored in the `DataArray_t` structure entities (see [Section 5.1](#)); `DataType` is `real` for all flow-solution identifiers defined in [Appendix A](#).
5. For unstructured zones `GridLocation` options are limited to `Vertex` or `CellCenter`, unless one of `PointList` or `PointRange` is present.
6. Indexing of data within the `DataArray_t` structures must be consistent with the associated numbering of vertices or elements.

`FlowSolution_t` requires four structure parameters; `CellDimension` identifies the dimensionality of cells or elements, `IndexDimension` identifies the dimensionality of the grid-size arrays, and `VertexSize` and `CellSize` are the number of core vertices and cells, respectively, in each index direction. For unstructured zones, `IndexDimension` is always 1.

The flow solution data is stored in the list of `DataArray_t` entities; each `DataArray_t` structure entity may contain a single component of the solution vector. Standardized data-name identifiers for the flow-solution quantities are described in [Appendix A](#). The field `GridLocation` specifies the location of the solution data with respect to the grid; if absent, the data is assumed to coincide with grid vertices (i.e., `GridLocation` = `Vertex`). All data within a given instance of `FlowSolution_t` must reside at the same grid location.

For structured grids, the value of `GridLocation` alone specifies the location and indexing of the flow solution data. Vertices are explicitly indexed. Cell centers and face centers are indexed using

the minimum of the connecting vertex indices, as described in the section Structured Grid Notation and Indexing Conventions (Section 3.2).

For unstructured grids, the value of `GridLocation` alone specifies location and indexing of flow solution data only for vertex and cell-centered data. The reason for this is that element-based grid connectivity provided in the `Elements_t` data structures explicitly indexes only vertices and cells. For data stored at alternate grid locations (e.g., edges), additional connectivity information is needed. This is provided by the optional fields `PointRange` and `PointList`; these refer to vertices, edges, faces or cell centers, depending on the values of `CellDimension` and `GridLocation`. Table 4 shows these relations. The `NODE` element type should not be used in place of the vertex. A vertex `GridLocation` should use the `GridLocation = Vertex` pattern, which implies an indexing on the grid coordinates arrays and not a `NODE Elements_t` array.

Table 4: `GridLocation` Usage

CellDimension	GridLocation			
	Vertex	EdgeCenter	*FaceCenter	CellCenter
1	vertices	—	—	cells (line elements)
2	vertices	edges	—	cells (area elements)
3	vertices	edges	faces	cells (volume elements)

In the table, `*FaceCenter` stands for the possible types: `FaceCenter`, `IFaceCenter`, `JFaceCenter` or `KFaceCenter`.

Although intended for edge or face-based solution data for unstructured grids, the fields `PointRange/List` may also be used to (redundantly) index vertex and cell-centered data. In all cases, indexing of flow solution data corresponds to the element numbering as defined in the `Elements_t` data structures.

`Rind` is an optional field that indicates the number of `rind` planes (for structured grids) or `rind` points or elements (for unstructured grids) included in the data. Its purpose and function are identical to those described in Section 7.1. Note, however, that the `Rind` in this structure is independent of the `Rind` contained in `GridCoordinates_t`. They are not required to contain the same number of `rind` planes or elements. Also, the location of any flow-solution `rind` points is assumed to be consistent with the location of the core flow solution points (e.g., if `GridLocation = CellCenter`, `rind` points are assumed to be located at fictitious cell centers).

`DataClass` defines the default class for data contained in the `DataArray_t` entities. For dimensional flow solution data, `DimensionalUnits` may be used to describe the system of units employed. If present these two entities take precedence over the corresponding entities at higher levels of the CGNS hierarchy. The rules for determining precedence of entities of this type are discussed in Section 6.4.

The `UserDefinedData_t` data structure allows arbitrary user-defined data to be stored in `Descriptor_t` and `DataArray_t` children without the restrictions or implicit meanings imposed on these node types at other node locations.

FUNCTION ListLength[]:

return value: int

dependencies: PointRange, PointList

FlowSolution_t requires the structure function ListLength, which is used to specify the number of entities (e.g. vertices) corresponding to a given PointRange or PointList. If PointRange is specified, then ListLength is obtained from the number of points (inclusive) between the beginning and ending indices of PointRange. If PointList is specified, then ListLength is the number of indices in the list of points. In this situation, ListLength becomes a user input along with the indices of the list PointList. By “user” we mean the application code that is generating the CGNS database.

FUNCTION DataSize[]:

return value: one-dimensional int array of length IndexDimension

dependencies: IndexDimension, VertexSize[], CellSize[], GridLocation, Rind, ListLength[]

The function DataSize[] is the size of flow solution data arrays. If Rind is absent then DataSize represents only the core points; it will be the same as VertexSize or CellSize depending on GridLocation. The definition of the function DataSize[] is as follows:

```
if (PointRange/PointList is present) then
{
  DataSize[] = ListLength[] ;
}
else if (Rind is absent) then
{
  if (GridLocation = Vertex) or (GridLocation is absent)
  {
    DataSize[] = VertexSize[] ;
  }
  else if (GridLocation = CellCenter) then
  {
    DataSize[] = CellSize[] ;
  }
}
else if (Rind is present) then
{
  if (GridLocation = Vertex) or (GridLocation is absent) then
  {
    DataSize[] = VertexSize[] + [a + b,...] ;
  }
  else if (GridLocation = CellCenter)
  {
    DataSize[] = CellSize[] + [a + b,...] ;
  }
}
```

```

    }
}

```

where `RindPlanes = [a,b,...]` (see [Section 4.8](#) for the definition of `RindPlanes`).

7.8 Flow Solution Example

This section contains an example of the flow solution entity, including the designation of grid location and rind planes and data-normalization mechanisms.

Example 7-H: Flow Solution

Conservation-equation variables (ρ , ρu , ρv and ρe_0) for a 2-D grid of size 11×5 . The flowfield is cell-centered with two planes of rind data. The density, momentum and stagnation energy (ρe_0) data is nondimensionalized with respect to a freestream reference state whose quantities are dimensional. The freestream density and pressure are used for normalization; these values are 1.226 kg/m^3 and $1.0132 \times 10^5 \text{ N/m}^2$ (standard atmosphere conditions). The data-name identifier conventions for the conservation-equation variables are `Density`, `MomentumX`, `MomentumY` and `EnergyStagnationDensity`.

```

! CellDimension = 2
! IndexDimension = 2
! VertexSize = [11,5]
! CellSize = [10,4]
FlowSolution_t<2, [11,5], [10,4]> FlowExample =
  {{
    GridLocation_t GridLocation = CellCenter ;

    Rind_t<2> Rind =
      {{
        int[4] RindPlanes = [2,2,2,2] ;
      }} ;

    DataClass_t DataClass = NormalizedByDimensional ;

    DimensionalUnits_t DimensionalUnits =
      {{
        MassUnits      = Kilogram ;
        LengthUnits    = Meter ;
        TimeUnits      = Second ;
        TemperatureUnits = TemperatureUnitsNull ;
        AngleUnits     = AngleUnitsNull ;
      }} ;

! DataType = real
! Dimension = 2

```

```
! DataSize = CellSize + [4,4] = [14,8]
DataArray_t<real, 2, [14,8]> Density =
  {{
    Data(real, 2, [14,8]) = ((rho(i,j), i=-1,12), j=-1,6) ;

    DataConversion_t DataConversion =
      {{
        ConversionScale = 1.226 ;
        ConversionOffset = 0 ;
      }} ;

    DimensionalExponents_t DimensionalExponents =
      {{
        MassExponent      = +1 ;
        LengthExponent    = -3 ;
        TimeExponent      = 0 ;
        TemperatureExponent = 0 ;
        AngleExponent     = 0 ;
      }} ;
  }} ;

DataArray_t<real, 2, [14,8]> MomentumX =
  {{
    Data(real, 2, [14,8]) = ((rho_u(i,j), i=-1,12), j=-1,6) ;

    DataConversion_t DataConversion =
      {{
        ConversionScale = 352.446 ;
        ConversionOffset = 0 ;
      }} ;
  }} ;

DataArray_t<real, 2, [14,8]> MomentumY =
  {{
    Data(real, 2, [14,8]) = ((rho_v(i,j), i=-1,12), j=-1,6) ;

    DataConversion_t DataConversion =
      {{
        ConversionScale = 352.446 ;
        ConversionOffset = 0 ;
      }} ;
  }} ;

DataArray_t<real, 2, [14,8]> EnergyStagnationDensity =
  {{
```



```

Data(real, 2, [14,8]) = ((rho_e0(i,j), i=-1,12), j=-1,6) ;

DataConversion_t DataConversion =
  {{
    ConversionScale = 1.0132e+05 ;
    ConversionOffset = 0 ;
  }} ;
}} ;
}} ;

```

The value of `GridLocation` indicates the data is at cell centers, and the value of `RindPlanes` specifies two rind planes on each face of the zone. The resulting value of the structure function `DataSize` is the number of cells plus four in each coordinate direction; this value is passed to each of the `DataArray_t` entities.

Since the data are all nondimensional and normalized by dimensional reference quantities, this information is stated in `DataClass` and `DimensionalUnits` at the `FlowSolution_t` level rather than attaching the appropriate `DataClass` and `DimensionalUnits` to each `DataArray_t` entity. It could possibly be at even higher levels in the heirarchy. The contents of `DataConversion` are in each case the denominator of the normalization; this is ρ_∞ for density, $\sqrt{p_\infty \rho_\infty}$ for momentum, and p_∞ for stagnation energy. The dimensional exponents are specified for density. For all the other data, the dimensional exponents are to be inferred from the data-name identifiers.

Note that no information is provided to identify the actual reference state or indicate that it is freestream. This information is not needed for data manipulations involving renormalization or changing the units of the converted raw data.

7.9 Zone Subregion Structure Definition: `ZoneSubRegion_t`

The `ZoneSubRegion_t` node allows for the ability to give flowfield or other information over a subset of the entire zone in a CGNS file. This subset may be over a portion of a boundary, or it may be over a portion of the entire field.

```

ZoneSubRegion_t< int IndexDimension, int CellDimension > :=
{
  List( Descriptor_t Descriptor1 ... DescriptorN ) ;           (o)
  List( Descriptor_t Descriptor1 ... DescriptorN ) ;           (o)

  int RegionCellDimension ;                                     (o/d)

  GridLocation_t GridLocation ;                                 (o/d)

  IndexRange_t<IndexDimension> PointRange ;                   (r:o:o:o)
  IndexArray_t<IndexDimension, ListLength, int> PointList ;   (o:r:o:o)
  Descriptor_t BCRegionName ;                                  (o:o:r:o)
  Descriptor_t GridConnectivityRegionName ;                   (o:o:o:r)

```

```
Rind_t<IndexDimension> Rind; (o/d)

List( DataArray_t<DataType, 1, ListLength[]>
      DataArray1 ... DataArrayN ) ; (o)

FamilyName_t FamilyName ; (o)

List( AdditionalFamilyName_t AddFamilyName1 ... AddFamilyNameN ) ; (o)

DataClass_t DataClass ; (o)

DimensionalUnits_t DimensionalUnits ; (o)

List( UserDefinedData_t UserDefinedData1 ... UserDefinedDataN ) ; (o)
} ;
```

Notes

1. Default names for the `Descriptor_t`, `DataArray_t`, and `UserDefinedData_t` lists are as shown; users may choose other legitimate names. Legitimate names must be unique within a given instance of `ZoneSubRegion_t` and shall not include the names `RegionCellDimension`, `Rind`, `PointRange`, `PointList`, `BCRegionName`, `GridConnectivityRegionName`, `FamilyName`, `DataClass` or `DimensionalUnits`.
2. `RegionCellDimension` must be equal to or less than the cell dimension for the zone. If absent, then its default value is `CellDimension`.
3. `GridLocation` has a default value of `Vertex` if absent. Permissible values of `GridLocation` are determined by `RegionCellDimension` (see below). All data within a given instance of `ZoneSubRegion_t` must reside at the same grid location.
4. The extent of the region and distribution of its data is specified by one of `PointRange`, `PointList`, `BCRegionName`, or `GridConnectivityRegionName`. One and only one of these must be specified.

The extent of the subregion and the distribution of data within that subregion is determined by `RegionCellDimension`, `GridLocation`, and one of `PointRange/List`, `BCRegionName`, or `GridConnectivityRegionName`. For a 3-D subregion (`RegionCellDimension = 3`), data can be located at vertices, edges, face centers or cell centers. For a 2-D subregion (`RegionCellDimension = 2`), data can be located at vertices, edges or cell centers (i.e. area elements). It is anticipated that one of the widest uses for `ZoneSubRegion_t` will be to store specific boundary-only information. For example, in a 3-D simulation, one may wish to store additional data on surfaces. In this case, the `RegionCellDimension` would be set to 2.

`PointRange/List` refer to vertices, edges, faces or cell centers, depending on the values of `RegionCellDimension` and `GridLocation`. Note that it is both the dimensionality of the zone (`CellDimension`) as well as the dimensionality of the subregion (`RegionCellDimension`), that determines the types of elements permissible in `PointRange/List`. [Table 5](#) shows these relations.

Table 5: GridLocation Usage with Zone Subregions

CellDimension	RegionCellDimension	GridLocation			
		Vertex	EdgeCenter	*FaceCenter	CellCenter
1	1	vertices	–	–	cells (line elements)
2	1	vertices	edges	–	–
2	2	vertices	edges	–	cells (area elements)
3	1	vertices	edges	–	–
3	2	vertices	edges	faces	–
3	3	vertices	edges	faces	cells (volume elements)

In the table, `*FaceCenter` stands for the possible types: `FaceCenter`, `IFaceCenter`, `JFaceCenter` or `KFaceCenter`.

For both structured and unstructured grids, `GridLocation = Vertex` means that `PointRange/List` refers to vertex indices. For structured grids, edges, faces and cell centers are indexed using the minimum of the connecting vertex indices, as described in the section Structured Grid Notation and Indexing Conventions (Section 3.2). For unstructured grids, edges, faces and cell centers are indexed using their element numbering, as defined in the `Elements_t` data structures (Section 7.3).

If the vertices or elements of the subregion are continuously numbered, then `PointRange` may be used. Otherwise, `PointList` should be used to list the vertices/elements. Alternatively, if the data locations and range of the subregion coincide with an existing BC region or zone-to-zone `GridConnectivity` region, then `BCRegionName` or `GridConnectivityRegionName` may be used. `BCRegionName` is a string giving the name of an existing `BC_t` node of the current zone. `GridConnectivityRegionName` is a string giving the name of an existing `GridConnectivity1to1_t` or `GridConnectivity_t` node of the current zone. The name referred to should be unambiguous.

Consistent with `FlowSolution_t`, the subregion’s solution data is stored in the list of `DataArray_t` entities; each `DataArray_t` structure entity contains a single quantity. Standardized data-name identifiers for solution quantities are described in the section Conventions for Data-Name Identifiers (A). As noted above, all solution data within a given subregion must reside at the same grid location.

`DataClass` defines the default class for data contained in the `DataArray_t` entities. For dimensional flow solution data, `DimensionalUnits` may be used to describe the system of units employed. If present, these two entities take precedence over the corresponding entities at higher levels of the CGNS hierarchy, following the standard precedence rules (Section 6.4).

`ZoneSubRegion_t` requires the structure function `ListLength[]`, which is used to specify the number of data points (e.g. vertices, cell centers, face centers, edge centers) corresponding to the given `PointRange/List`. If `PointRange` is specified, then `ListLength` is obtained from the number of points (inclusive) between the beginning and ending indices of `PointRange`. If `PointList` is specified, then `ListLength` is the number of indices in the list of points. In this situation, `ListLength` becomes a user input along with the indices of the list `PointList`. By “user” we mean the application code that is generating the CGNS database.

`Rind` is an optional field that indicates the number of rind planes (for structured grids) or rind points (for unstructured grids). If `Rind` is absent, then the `DataArray_t` structure entities contain only core data of length `ListLength`, as defined for this region. If `Rind` is present, it will provide

information on the number of rind elements, in addition to the `ListLength`, that are contained in the `DataArray_t` structures. The bottom line is that `Rind` simply adds a specified number to `ListLength`, as used by the `DataArray_t` structures.

The `UserDefinedData_t` data structure allows arbitrary user-defined data to be stored.

There may be multiple instances of `ZoneSubRegion_t` in a given zone. These may simply be multiple regions defined for a single solution, or they may be associated with different times / different solutions in a time-dependent simulation (in which case `ZoneIterativeData` (Section 11.1.2) should be used to associate them).

All `FamilyName` and `AdditionalFamilyName` entries should respect the rules defined in Section 6.2.1 and Section 6.3.

7.10 Zone Subregion Examples

This section contains four examples of Zone Subregions, including the use of `PointList`, `PointRange` and `BCRegionName`.

Example 7-I: Volume Subregion for a Structured Grid

For this example, it is assumed that a 1-zone 3-D structured grid exists of size $(197 \times 97 \times 33)$. Inside of this zone, the user wishes to output a special subset region of interior data (say, temperature and kinematic viscosity) at the specific cell-center locations $i = 121-149$, $j = 17-45$, $k = 21-23$. Even though this same data may possibly exist under `FlowSolution_t` (which holds the flowfield data for the entire zone), this particular location may represent a special region of interest where the user wants to focus attention or output different types of flowfield variables or user-defined data. Note that for structured grids, the location list always references grid nodes; in this case with `GridLocation = Cellcenter` the cell centers are indexed by the minimum i , j , and k indices of the connecting vertices.

Under `Zone_t`:

```
ZoneSubRegion_t<3,3> Region1 =
  {{
  GridLocation_t GridLocation = CellCenter ;
  int RegionCellDimension = 3;
  IndexRange_t<3> PointRange =
    {{
    int[3] Begin = [121,17,21];
    int[3] End = [149,45,21];
    }};

  ! ListLength = (149-121+1)*(45-17+1)*(23-21+1) = 29*29*3 = 2523
  DataArray_t<real,1,2523> Temperature =
    {{
    Data(real,1,2523) = temperature at the cell centers specified
```

```
    }} ;  
DataArray_t<real,1,2523> ViscosityKinematic =  
    {{  
    Data(real,1,2523) = kinematic viscosity at the cell centers specified  
    }} ;  
}} ; ! end Region1
```

Example 7-J: Volume Subregion for an Unstructured Grid

This example is like the previous one, except it is for an unstructured zone. Inside of this zone, the user wishes to output a special subset region of data (say, temperature and kinematic viscosity) at a specific list of 2523 element cell-center locations, located somewhere within the (larger) field of elements. Recall that when `GridLocation` is anything other than `Vertex` in conjunction with unstructured grids, then the location list represents element numbers and not grid node numbers.

Under `Zone_t`:

```
ZoneSubRegion_t<1,3> Region1 =  
    {{  
    GridLocation_t GridLocation = CellCenter ;  
    int RegionCellDimension = 3;  
    IndexArray_t<1,2523,int> PointList =  
        {{  
        int[1] ElementList = list of 3-D element numbers where region data given  
        }} ;  
  
    ! ListLength = length of the element list = 2523  
    DataArray_t<real,1,2523> Temperature =  
        {{  
        Data(real,1,2523) = temperature at the element cell centers specified  
        }} ;  
    DataArray_t<real,1,2523> ViscosityKinematic =  
        {{  
        Data(real,1,2523) = kinematic viscosity at the element cell centers specified  
        }} ;  
    }} ; ! end Region1
```

Example 7-K: Surface Subregion for an Unstructured Grid

In this example, boundary data is output on a 2-D surface subregion of a 3-D problem. Because this is data on a topologically 2-D boundary (in a 3-D simulation), `RegionCellDimension` is set to 2. `GridLocation` is specified as `FaceCenter`. Recall that when `GridLocation` is anything other than `Vertex` in conjunction with unstructured grids, then the location list represents element numbers and not grid node numbers. Thus, the `PointList/Range` indicates particular surface elements (or boundary elements) that need to have been defined in the file under their own `Elements_t` node(s),

separate from the 3-D volume elements that make up the grid. In this case, we assume that the surface element numbers at which we are outputting data are 5568 through 5592 inclusive. Because the numbers occur in sequential order, we can make use of `PointRange`.

Under `Zone_t`:

```
ZoneSubRegion_t<1,3> Region1 =
  {{
  GridLocation_t GridLocation = FaceCenter ;
  int RegionCellDimension = 2;
  IndexArray_t<1,25,int> PointRange =
    {{
    int[1] Begin = [5568];
    int[1] End = [5592];
    }} ;

  ! ListLength = length of the element list = 25
  DataArray_t<real,1,25> Temperature =
    {{
    Data(real,1,25) = temperature at the specific face element locations
                      specified
    }} ;
  DataArray_t<real,1,25> ViscosityKinematic =
    {{
    Data(real,1,25) = kinematic viscosity at the specific face element
                      locations specified
    }} ;
  }} ; ! end Region1
```

Example 7-L: Surface Subregion Utilizing BC Information

In this example, boundary data is output at the same locations where the BCs are specified in a particular `BC_t` node (in this case the `ListLength` is 25). Note that because this is data on a topologically 2-D boundary (in a 3-D simulation), `RegionCellDimension` is set to 2. `GridLocation` is not specified, because it is inherited from the `BC_t` node along with the `ListLength`.

Under `Zone_t`:

```
ZoneSubRegion_t<1,3> Region1 =
  {{
  int RegionCellDimension = 2;
  Descriptor_t BCRegionName = "name of a ZoneBC/BC_t node" ;

  ! ListLength = length of the point/element list from BC_t = 25
  DataArray_t<real,1,25> Temperature =
```

```
  {{
  Data(real,1,25) = temperature at the specific BC locations
                    specified
  }} ;
dataArray_t<real,1,25> ViscosityKinematic =
  {{
  Data(real,1,25) = kinematic viscosity at the specific BC
                    locations specified
  }} ;
}} ; ! end Region1
```

8 Multizone Interface Connectivity

This section defines structures for describing multizone interface connectivity for 1-to-1 abutting, mismatched abutting, and overset type interfaces. The different types of zone interfaces are described in [Section 3.4](#). All interface connectivity information pertaining to a given zone is grouped together in a `ZoneGridConnectivity_t` structure entity; this in turn is contained in a zone structure entity (see the definition of `Zone_t` in [Section 6.3](#)).

Before presentation of the structure definitions, a few design features require comment. All indices used to describe interfaces are the dimensionality (`IndexDimension`) of the grid, even when they are used to describe lower-dimensional zonal boundaries for abutting interfaces. The alternative for structured zones that was not chosen is to use lower-dimensional indices for lower-dimensional interfaces (e.g., for a 3-D grid, use two-dimensional indices for describing grid planes that are interfaces). Both alternatives offer trade-offs. The lower-dimensional indices require cyclic notation conventions and additional identification of face location; whereas, full-dimensional indices result in one redundant index component when describing points along a grid plane. We decided that full-dimensional indices would be more usable and less error prone in actual implementation.

A major consequence of this decision is that connectivity information for describing mismatched abutting interfaces and overset interfaces can be merged into a single structure, `GridConnectivity_t` (see [Section 8.4](#) below). In fact, this single structure type can be used to describe all zonal interfaces.

A second design choice was to duplicate all 1-to-1 abutting interface information within the CGNS database. It is possible to describe a given 1-to-1 interface with a single set of connectivity data. In contrast, mismatched and overset interfaces require different connectivity information when the roles of receiver and donor zones are interchanged. Therefore, a given mismatched or overset interface requires two sets of connectivity data within the database. The decision to force two sets of connectivity data (one contained in each of the `Zone_t` entities for the two adjacent zones) for each 1-to-1 interface makes the connectivity structures for all interface types look and function similarly. It also fits better with the zone-by-zone hierarchy chosen for the CGNS database. The minor penalty in data duplication was deemed worth the advantages gained.

Note that it is a CGNS design intent that a given zone boundary segment or location should at most be defined (or covered) by either a boundary condition or a multizone interface connectivity, but not by both.

8.1 Zonal Connectivity Structure Definition: `ZoneGridConnectivity_t`

All multizone interface grid connectivity information pertaining to a given zone is contained in the `ZoneGridConnectivity_t` structure. This includes abutting interfaces (1-to-1 and general mismatched), overset-grid interfaces, and overset-grid holes.

```
ZoneGridConnectivity_t< int IndexDimension, int CellDimension > :=  
  {  
    List( Descriptor_t Descriptor1 ... DescriptorN ) ;           (o)
```

```
List( GridConnectivity1to1_t<IndexDimension>
      GridConnectivity1to11 ... GridConnectivity1to1N ) ;      (o)

List( GridConnectivity_t<IndexDimension, CellDimension>
      GridConnectivity1 ... GridConnectivityN ) ;              (o)

List( OversetHoles_t<IndexDimension>
      OversetHoles1 ... OversetHolesN ) ;                      (o)

List( UserDefinedData_t UserDefinedData1 ... UserDefinedDataN ) ;      (o)
} ;
```

Notes

1. Default names for the `Descriptor_t`, `GridConnectivity1to1_t`, `GridConnectivity_t`, `OversetHoles_t`, and `UserDefinedData_t` lists are as shown; users may choose other legitimate names. Legitimate names must be unique within a given instance of `ZoneGridConnectivity_t`.
2. All lists within the `ZoneGridConnectivity_t` structure may be empty.

`ZoneGridConnectivity_t` requires two structure parameters, `IndexDimension`, which is passed onto all connectivity substructures, and `CellDimension`, which is passed to `GridConnectivity_t` only.

Connectivity information for 1-to-1 or matched multizone interfaces is contained in the `GridConnectivity1to1_t` structure. Abutting and overset connectivity is contained in the `GridConnectivity_t` structure, and overset-grid holes are identified in the `OversetHoles_t` structure.

The `UserDefinedData_t` data structure allows arbitrary user-defined data to be stored in `Descriptor_t` and `DataArray_t` children without the restrictions or implicit meanings imposed on these node types at other node locations.

8.2 1-to-1 Interface Connectivity Structure Definition: `GridConnectivity1to1_t`

`GridConnectivity1to1_t` only applies to structured zones interfacing with structured donors and whose interface is a logically rectangular region. It contains connectivity information for a multizone interface patch that is abutting with 1-to-1 matching between adjacent zone indices (also referred to as C0 connectivity). An interface patch is the subrange of the face of a zone that touches one and only one other zone. This structure identifies the subrange of indices for the two adjacent zones that make up the interface and gives an index transformation from one zone to the other. It also identifies the name of the adjacent zone.

All the interface patches for a given zone are contained in the `ZoneGridConnectivity_t` entity for that zone. If a face of a zone touches several other zones (say N), then N different instances of the `GridConnectivity1to1_t` structure must be included in the zone to describe each separate interface patch. This convention requires that a single interface patch be described twice in the database—once for each adjacent zone.

```

GridConnectivity1to1_t< int IndexDimension > :=
{
  List( Descriptor_t Descriptor1 ... DescriptorN ) ;           (o)

  int[IndexDimension] Transform ;                             (o/d)

  IndexRange_t<IndexDimension> PointRange ;                  (r)
  IndexRange_t<IndexDimension> PointRangeDonor ;            (r)

  Identifier(Zone_t) ZoneDonorName ;                         (r)

  GridConnectivityProperty_t GridConnectivityProperty ;    (o)

  List( UserDefinedData_t UserDefinedData1 ... UserDefinedDataN ) ; (o)

  int Ordinal ;                                             (o)
} ;

```

Notes

1. Default names for the `Descriptor_t` and `UserDefinedData_t` lists are as shown; users may choose other legitimate names. Legitimate names must be unique within a given instance of `GridConnectivity1to1_t` and shall not include the names `GridConnectivityProperty`, `PointRange`, `PointRangeDonor`, `Transform`, or `Ordinal`.
2. If `Transform` is absent, then its default value is `[+1, +2, +3]`.
3. `ZoneDonorName` must be equated to a 32 character maximum zone identifier within the current CGNS database (i.e., it must be equal to one of the `Zone_t` identifiers contained in the current `CGNSBase_t` entity) or to a 65 character maximum zone identifier in another base of the same CGNS tree; in that case the `ZoneDonorName` string has the pattern `base/zone`, only one single “/” character is allowed, and neither `basename` nor `zonename` should be empty. `ZoneDonorName` should also not be empty.
4. Beginning indices of `PointRange` and `PointRangeDonor` must coincide (i.e., must be the same physical point); ending indices of `PointRange` and `PointRangeDonor` must also coincide.
5. Elements of `Transform` must be signed integers in the range `-IndexDimension, ..., +IndexDimension`; element magnitudes may not be repeated. In 3-D allowed elements are `0, ±1, ±2, ±3`.

`PointRange` contains the subrange of indices that makes up the interface patch in the current zone (i.e., that `Zone_t` entity that contains the given instance of `GridConnectivity1to1_t`). `PointRangeDonor` contains the interface patch subrange of indices for the adjacent zone (whose identifier is given by `ZoneDonorName`). By convention the indices contained in `PointRange` and `PointRangeDonor` refer to vertices.

`Transform` contains a short-hand notation for the transformation matrix describing the relation between indices of the two adjacent zones. The transformation matrix itself has rank `IndexDimension`

and contains elements +1, -1 and 0; it is orthonormal and its inverse is its transpose. The transformation matrix (**T**) works as follows: if **Index1** and **Index2** are the indices of a given point on the interface, where **Index1** is in the current zone and **Index2** is in the adjacent zone, then their relationship is,

$$\text{Index2} = \mathbf{T} \cdot (\text{Index1} - \text{Begin1}) + \text{Begin2}$$

$$\text{Index1} = \text{Transpose}[\mathbf{T}] \cdot (\text{Index2} - \text{Begin2}) + \text{Begin1}$$

where the “.” notation indicates matrix-vector multiply. **Begin1** and **End1** are the subrange indices contained in **PointRange**, and **Begin2** and **End2** are the subrange indices contained in **PointRangeDonor**.

The short-hand notation used in **Transform** is as follows: each element shows the image in the adjacent zone’s face of a positive index increment in the current zone’s face. The first element is the image of a positive increment in *i*; the second element is the image of an increment in *j*; and the third (in 3-D) is the image of an increment in *k* on the current zone’s face. For 3-D, the transformation matrix **T** is constructed from **Transform** = [$\pm a, \pm b, \pm c$] as follows:

$$\mathbf{T} = \begin{bmatrix} \text{sgn}(a) \text{del}(a - 1) & \text{sgn}(b) \text{del}(b - 1) & \text{sgn}(c) \text{del}(c - 1) \\ \text{sgn}(a) \text{del}(a - 2) & \text{sgn}(b) \text{del}(b - 2) & \text{sgn}(c) \text{del}(c - 2) \\ \text{sgn}(a) \text{del}(a - 3) & \text{sgn}(b) \text{del}(b - 3) & \text{sgn}(c) \text{del}(c - 3) \end{bmatrix},$$

where,

$$\text{sgn}(x) \equiv \begin{cases} +1, & \text{if } x \geq 0 \\ -1, & \text{if } x < 0 \end{cases} \quad \text{del}(x - y) \equiv \begin{cases} 1, & \text{if } \text{abs}(x) = \text{abs}(y) \\ 0, & \text{otherwise} \end{cases}$$

For example, **Transform** = [-2, +3, +1] gives the transformation matrix,

$$\mathbf{T} = \begin{bmatrix} 0 & 0 & +1 \\ -1 & 0 & 0 \\ 0 & +1 & 0 \end{bmatrix}.$$

For establishing relationships between adjacent and current zone indices lying on the interface itself, one of the elements of **Transform** is superfluous since one component of both interface indices remains constant. It is therefore acceptable to set that element of **Transform** to zero.

If the transformation matrix is used for continuation of computational coordinates into the adjacent zone (e.g., to find the location of a rind point in the adjacent zone), then all elements of **Transform** are needed. If the above mentioned superfluous element is set to zero, it can be easily regenerated from **PointRange** and **PointRangeDonor** and the grid sizes of the two zones. This is done by determining the faces represented by **PointRange** and **PointRangeDonor** (i.e., *i*-min, *i*-max, *j*-min, etc.). If one is a minimum face and the other a maximum face, then the sign of the missing element in **Transform** is “+”, and the value of the missing element in the transformation matrix (**T**) is +1. If the faces are both minimums or are both maximums, the sign is “-”. Next, the position and magnitude of the element in **Transform**, and hence the row and column in the transformation matrix, is given by the combinations of *i*, *j* and *k* faces for the two. For example, if **PointRange** represents a *j*-min or *j*-max face and **PointRangeDonor** represents an *i*-min or *i*-max face, then

the missing element's position in `Transform` is 2 and its magnitude is 1 (i.e., `Transform = [*, ±1, *]`).

Note also that the transform matrix and the two index pairs overspecify the interface patch. For example, `End2` can be obtained from `Transform`, `Begin1`, `End1` and `Begin2`.

A `GridConnectivityProperty_t` data structure, described in [Section 8.6](#), may be used to record special properties associated with particular connectivity patches, such as a periodic interface, or an interface where data is to be averaged in some way.

The `UserDefinedData_t` data structure allows arbitrary user-defined data to be stored in `Descriptor_t` and `DataArray_t` children without the restrictions or implicit meanings imposed on these node types at other node locations.

`Ordinal` is user-defined and has no restrictions on the values that it can contain. It is included for backward compatibility to assist implementation of the CGNS system into applications whose I/O depends heavily on the numbering of zone interfaces. Since there are no restrictions on the values contained in `Ordinal` (or that `Ordinal` is even provided), there is no guarantee that the interfaces in an existing CGNS database will have sequential values from 1 to N without holes or repetitions. Use of `Ordinal` is discouraged and is on a user-beware basis.

8.3 1-to-1 Interface Connectivity Examples

This section contains two examples of structure entities for describing the connectivity for structured-zone 1-to-1 abutting multizone interfaces. [Appendix B](#) contains additional examples of 1-to-1 interfaces.

Example 8-A: 1-to-1 Abutting of Complete Faces

Two zones have the same orientation; zone 1 is $9 \times 17 \times 11$ and zone 2 is $9 \times 17 \times 21$. The k -max face of zone 1 abuts the k -min face of zone 2. Contained in the structure entities of zone 1 is the following interface structure:

```
GridConnectivity1to1_t<3> Zone1/ZoneGridConnectivity/KMax =
  {{
    int[3] Transform = [1,2,3] ;
    IndexRange_t<3> PointRange =
      {{
        int[3] Begin = [1,1,11] ;
        int[3] End   = [9,17,11] ;
      }} ;
    IndexRange_t<3> PointRangeDonor =
      {{
        int[3] Begin = [1,1,1] ;
        int[3] End   = [9,17,1] ;
      }} ;
    Identifier(Zone_t) ZoneDonorName = Zone2 ;
  }} ;
```

Contained in the structure entities of zone 2 is the following:

```
GridConnectivity1to1_t<3> Zone2/ZoneGridConnectivity/KMin =
  {{
    int[3] Transform = [1,2,3] ;
    IndexRange_t<3> PointRange =
      {{
        int[3] Begin = [1,1,1] ;
        int[3] End   = [9,17,1] ;
      }} ;
    IndexRange_t<3> PointRangeDonor =
      {{
        int[3] Begin = [1,1,11] ;
        int[3] End   = [9,17,11] ;
      }} ;
    Identifier(Zone_t) ZoneDonorName = Zone1 ;
  }} ;
```

This example assumes zones 1 and 2 have the identifiers Zone1 and Zone2, respectively.

Example 8-B: 1-to-1 Abutting, Complete Face to a Subset of a Face

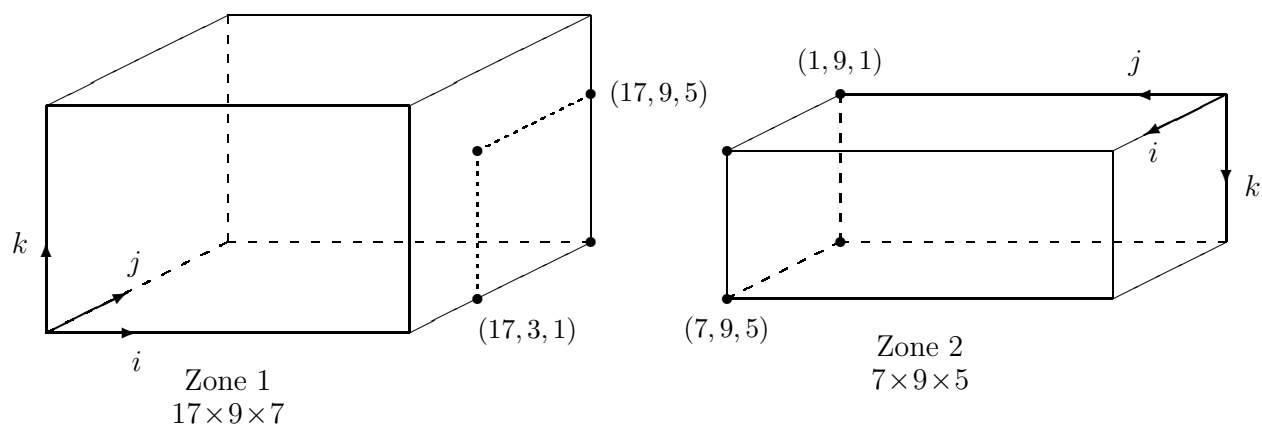

Figure 5: Example Interface for 1-to-1 Connectivity

Figure 5 shows a more complex 1-to-1 abutting interface, where the entire j -max face of zone 2 coincides with a subset of the i -max face of zone 1. This situation would result in the following connectivity structures:

```
GridConnectivity1to1_t<3> Zone1/ZoneGridConnectivity/IMax =
  {{
    int[3] Transform = [-2,-1,-3] ;
    IndexRange_t<3> PointRange =
      {{
```

```

    int[3] Begin = [17,3,1] ;
    int[3] End   = [17,9,5] ;
  }} ;
  IndexRange_t<3> PointRangeDonor =
  {{
    int[3] Begin = [7,9,5] ;
    int[3] End   = [1,9,1] ;
  }} ;
  Identifier(Zone_t) ZoneDonorName = Zone2 ;
}} ;

GridConnectivity1to1_t<3> Zone2/ZoneGridConnectivity/JMax =
{{
  int[3] Transform = [-2,-1,-3] ;
  IndexRange_t<3> PointRange =
  {{
    int[3] Begin = [1,9,1] ;
    int[3] End   = [7,9,5] ;
  }} ;
  IndexRange_t<3> PointRangeDonor =
  {{
    int[3] Begin = [17,9,5] ;
    int[3] End   = [17,3,1] ;
  }} ;
  Identifier(Zone_t) ZoneDonorName = Zone1 ;
}} ;

```

This example also assumes zones 1 and 2 have the identifiers `Zone1` and `Zone2`, respectively. Note that the index transformation matrix for both this and the previous examples is symmetric; hence, the value of `Transform` is identical for both members of the interface pair. In general this will not always be the case.

8.4 General Interface Connectivity Structure Definition: `GridConnectivity_t`

`GridConnectivity_t` contains connectivity information for generalized multizone interfaces, and may be used for any mix of structured and unstructured zones. Its purpose is to describe mismatched-abutting and overset interfaces, but can also be used for 1-to-1 abutting interfaces.

For abutting interfaces that are not 1-to-1, also referred to as patched or mismatched, an interface patch is the subrange of the face of a zone that touches one and only one other zone. This structure identifies the subrange of indices (or array of indices) that make up the interface and gives their image in the adjacent (donor) zone. It also identifies the name of the adjacent zone. If a given face of a zone touches several (say N) adjacent zones, then N different instances of `GridConnectivity_t` are needed to describe all the interfaces. For a single abutting interface, two instances of `GridConnectivity_t` are needed in the database – one for each adjacent zone.

For overset interfaces, this structure identifies the fringe points of a given zone that lie in one and only one other zone. If the fringe points of a zone lie in several (say N) overlapping zones, then N different instances of `GridConnectivity_t` are needed to describe the overlaps. It is possible with overset grids that a single fringe point may actually lie in several overlapping zones (though in typical usage, linkage to only one of the overlapping zones is kept). There is no restriction against a given fringe point being contained within multiple instances of `GridConnectivity_t`; therefore, this structure allows the description of a single fringe point lying in several overlapping zones.

```
GridConnectivityType_t := Enumeration(  
  GridConnectivityTypeNull,  
  GridConnectivityTypeUserDefined,  
  Overset,  
  Abutting,  
  Abutting1to1 ) ;  
  
GridConnectivity_t< int IndexDimension, int CellDimension > :=  
{  
  List( Descriptor_t Descriptor1 ... DescriptorN ) ;           (o)  
  
  GridConnectivityType_t GridConnectivityType ;             (o/d)  
  
  GridLocation_t GridLocation ;                             (o/d)  
  
  IndexRange_t<IndexDimension> PointRange ;                 (o:r)  
  IndexArray_t<IndexDimension, PointListSize, int> PointList ; (r:o)  
  IndexArray_t<IndexDimension, PointListSize, int> PointListDonor ; (o)  
  IndexArray_t<IndexDimension, PointListSize, int> CellListDonor ; (o)  
  
  Identifier(Zone_t) ZoneDonorName ;                         (r)  
  
  DataArray_t <real, 2, [CellDimension, PointListSize]> InterpolantsDonor (o)  
  
  GridConnectivityProperty_t GridConnectivityProperty ;    (o)  
  
  List( UserDefinedData_t UserDefinedData1 ... UserDefinedDataN ) ; (o)  
  
  int Ordinal ;                                             (o)  
} ;
```

Notes

1. Default names for the `Descriptor_t` and `UserDefinedData_t` lists are as shown; users may choose other legitimate names. Legitimate names must be unique within a given instance of `GridConnectivity_t` and shall not include the names `CellListDonor`, `GridConnectivityProperty`, `GridConnectivityType`, `GridLocation`, `InterpolantsDonor`, `Ordinal`, `PointList`, `PointListDonor`, or `PointRange`.

2. `ZoneDonorName` must be equated to a 32 characters maximum zone identifier within the current CGNS database (i.e., it must be equal to one of the `Zone_t` identifiers contained in the current `CGNSBase_t` entity) or to a 65 characters maximum zone identifier in another base of the same CGNS tree, in that case the `ZoneDonorName` string has the pattern `base/zone`, only one single “/” character is allowed, and neither `basename` nor `zonename` should be empty. `ZoneDonorName` should also not be empty.
3. If `GridConnectivityType` is absent, then its default value is `Overset`.
4. For `Abutting` or `Abutting1to1` interfaces, `GridLocation` can be either `Vertex` or `FaceCenter`. When `GridLocation` is set to `Vertex`, then `PointList` or `PointRange` refer to node indices, for both structured and unstructured grids. When `GridLocation` is set to `FaceCenter`, then `PointList` or `PointRange` refer to face elements. Face elements are indexed using different methods depending if the zone is structured or unstructured. For a structured zone, face elements are indexed using the minimum of the connecting vertex indices, as described in [Section 3.2](#). For an unstructured zone, face elements are indexed using their element numbering, as defined in the `Elements_t` data structures. For `Overset` interfaces, `GridLocation` can be either `Vertex` or `CellCenter`, allowing the description of the overlap region in the receiver zone to be consistent with the grid location used for storing the flow solution. If `GridLocation` is absent, then its default value is `Vertex`.
5. One of `PointRange` and `PointList` must be specified, but not both.
6. If `PointRange` is specified, then an index ordering convention is needed to map receiver-zone grid points to donor-zone grid points. FORTRAN multidimensional array ordering is used.
7. If `GridConnectivityType` is `Abutting1to1` or `Abutting`, then `PointRange` or `PointList` must define points associated with a face subrange (if the zone is structured, all points must be in a single computational grid plane); the donor-zone grid locations defined by `PointListDonor` or `CellListDonor` must also be associated with a face subrange.
8. If donor information is given, either `PointListDonor` alone, or `CellListDonor` with or without `InterpolantsDonor`, must be used. The use of `PointListDonor` is restricted to `Abutting1to1`, whereas `CellListDonor` can be used for any interface type.
9. Thus, for a `GridConnectivityType` that is not `Abutting1to1`, there are three allowable levels of description concerning the connectivity information: (a) full, giving `ZoneDonorName` with `CellListDonor` plus `InterpolantsDonor`; (b) partial, giving `ZoneDonorName` with `CellListDonor` but no `InterpolantsDonor`; or (c) minimal, giving `ZoneDonorName` only.

The type of multizone interface connectivity may be `Overset`, `Abutting`, or `Abutting1to1`. `Overset` refers to zones that overlap; for a 3-D configuration the overlap is a 3-D region. `Abutting` refers to zones that abut or touch, but do not overlap (other than the vertices and faces that make up the interface). `Abutting1to1` is a special case of abutting interfaces where grid lines are continuous across the interface and all vertices on the interface are shared by the two adjacent zones. See [Section 3.4](#) for a description of the three different types of interfaces.

The interface grid points within the receiver zone may be specified by `PointRange` if they constitute a logically rectangular region (e.g., an abutting interface where an entire face of the receiver zone abuts with a part of a face of the donor zone). In all other cases, `PointList` should be used to list the receiver-zone grid points making up the interface. For a structured-to-structured interface, all indices in `PointRange` or `PointList` should have one index element in common (see note 7).

`GridLocation` identifies the location of indices within the receiver zone described by `PointRange` or `PointList`. It also identifies the location of indices defined by `PointListDonor` in the donor zone. `GridLocation` does *not* apply to `CellListDonor` or `InterpolantsDonor`. The `CellListDonor` is always an index or indices that define a particular cell or element, while the `InterpolantsDonor` defines an interpolation value relative to the cell/element *vertices*. In other words, when using `InterpolantsDonor`, the interpolants are always given with respect to the vertices of the donor zone. `InterpolantsDonor` is currently only defined for structured grids and certain basic unstructured grid element types.

For structured grids, the interpolant value is given along each index direction, depending on the location within the cell. For example, if the point is located within the cell at a position 75% in the i -direction, 41% in the j -direction, and 20% in the k -direction, then `InterpolantsDonor` values (r, s, t) would be (0.75, 0.41, 0.20).

The interpolation function is a linear combination of the $x, y,$ and z values at the surrounding nodes:

$$d = \sum_{i=1}^N W_i \cdot d_i$$

where d is the $x, y,$ or z value at an interior point in the cell, d_i is the $x, y,$ or z value at node i , and W_i is a weight at node i . The weights are functions of the parametric variables $r, s,$ and t (corresponding with the $i, j,$ and k directions, respectively), which vary from 0 to 1, inclusively. For structured grids in 3-D, $N = 8$. Note that for skewed, non-parallel grids, it is not always easy to determine the interpolants geometrically, and it may be necessary to solve an inverse problem using the interpolation function.

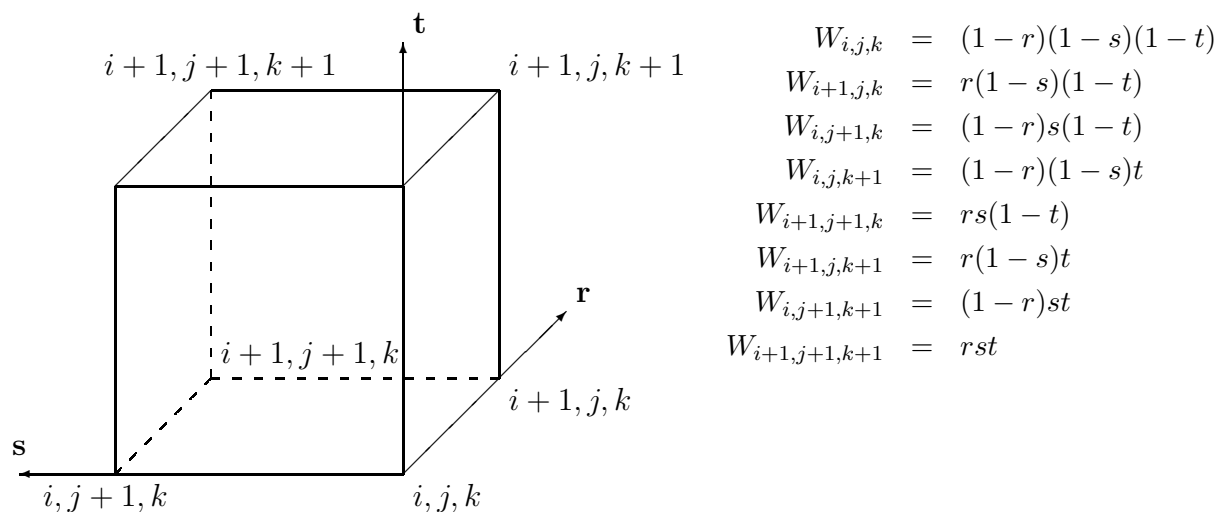

For unstructured grids, `InterpolantsDonor` is defined only for the basic linear element types: `BAR_2`, `TRI_3`, `QUAD_4`, `TETRA_4`, `PYRA_5`, `PENTA_6`, and `HEXA_8`, defined in [Section 3.3](#). The directionality for the $r, s,$ and t interpolants for the basic element types is defined as follows.

`BAR_2`

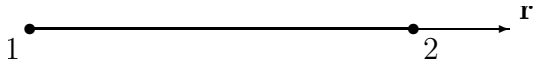

$$W_1 = 1 - r$$

$$W_2 = r$$

TRI_3

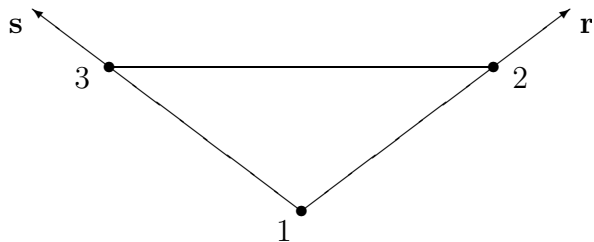

$$\begin{aligned} W_1 &= 1 - r - s \\ W_2 &= r \\ W_3 &= s \end{aligned}$$

QUAD_4

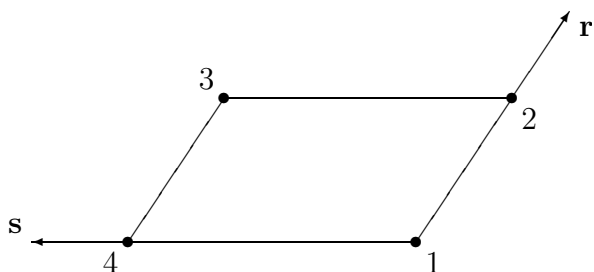

$$\begin{aligned} W_1 &= (1 - r)(1 - s) \\ W_2 &= r(1 - s) \\ W_3 &= rs \\ W_4 &= (1 - r)s \end{aligned}$$

TETRA_4

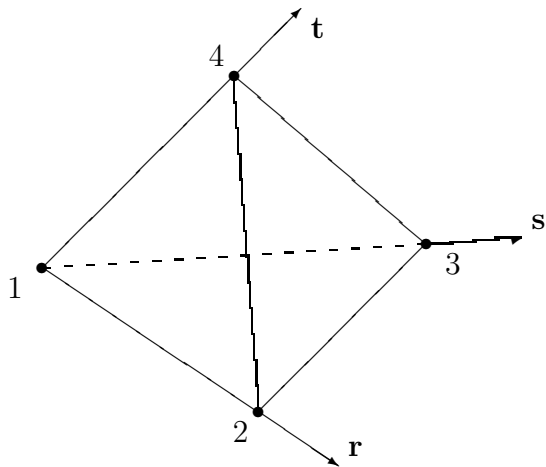

$$\begin{aligned} W_1 &= 1 - r - s - t \\ W_2 &= r \\ W_3 &= s \\ W_4 &= t \end{aligned}$$

PYRA_5

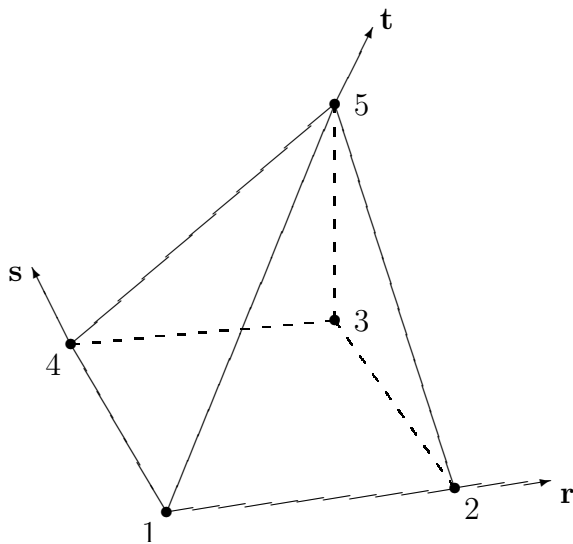

$$W_1 = (1-r)(1-s)(1-t)$$

$$W_2 = r(1-s)(1-t)$$

$$W_3 = rs(1-t)$$

$$W_4 = (1-r)s(1-t)$$

$$W_5 = t$$

PENTA_6

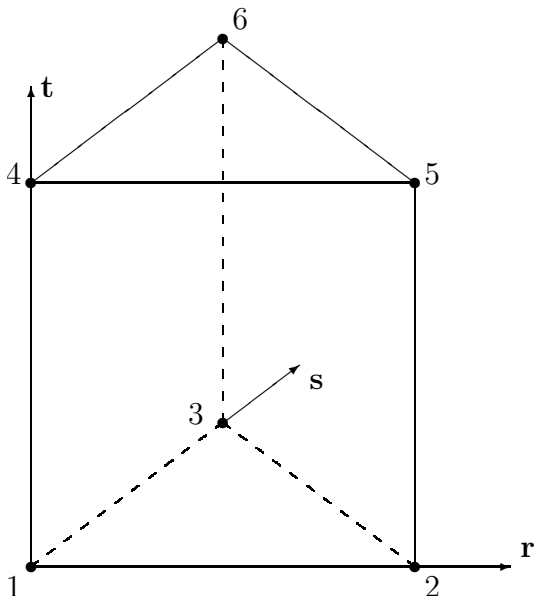

$$W_1 = (1-r-s)(1-t)$$

$$W_2 = r(1-t)$$

$$W_3 = s(1-t)$$

$$W_4 = (1-r-s)t$$

$$W_5 = rt$$

$$W_6 = st$$

HEXA_8

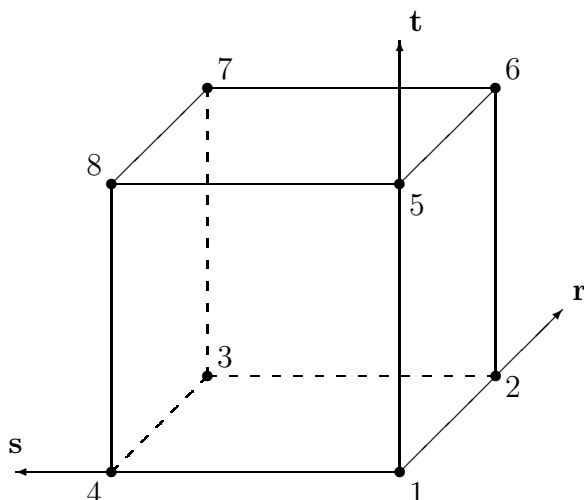

$$W_1 = (1-r)(1-s)(1-t)$$

$$W_2 = r(1-s)(1-t)$$

$$W_3 = rs(1-t)$$

$$W_4 = (1-r)s(1-t)$$

$$W_5 = (1-r)(1-s)t$$

$$W_6 = r(1-s)t$$

$$W_7 = rst$$

$$W_8 = (1-r)st$$

`PointListDonor` may only be used when the interface is `Abutting1to1`. It contains the images of all the receiver-zone interface points in the donor zone. If the zone is structured, all indices in `PointListDonor` should have one index element in common.

For mismatched or overset interfaces, the zone connectivity donor information, when given, is defined using either the `CellListDonor` alone, or the combination of `CellListDonor` and `InterpolantsDonor`. `CellListDonor` contains the list of donor cells or elements in which each node of the receiver zone can be located. `InterpolantsDonor` contains the interpolation factors to locate the receiver nodes in the donor cells. `InterpolantsDonor` may be thought of as bi- or tri-linear interpolants (depending on `CellDimension`) in the cell of the donor zone.

A `GridConnectivityProperty_t` data structure, described in [Section 8.6](#), may be used to record special properties associated with particular connectivity patches, such as a periodic interface, or an interface where data is to be averaged in some way.

The `UserDefinedData_t` data structure allows arbitrary user-defined data to be stored in `Descriptor_t` and `DataArray_t` children without the restrictions or implicit meanings imposed on these node types at other node locations.

`Ordinal` is user-defined and has no restrictions on the values that it can contain. It is included for backward compatibility to assist implementation of the CGNS system into applications whose I/O depends heavily on the numbering of zone interfaces. Since there are no restrictions on the values contained in `Ordinal` (or that `Ordinal` is even provided), there is no guarantee that the interfaces for a given zone in an existing CGNS database will have sequential values from 1 to N without holes or repetitions. Use of `Ordinal` is discouraged and is on a user-beware basis.

FUNCTION `PointListSize`:

return value: `int`

dependencies: `PointRange`, `PointList`

`PointListDonor`, `CellListDonor`, and `InterpolantsDonor` require the function `PointListSize`, to identify the length of the array. If `PointRange` is specified by `GridConnectivity_t`, then `PointListSize` is obtained from the number of grid points (inclusive) between the beginning and ending indices of `PointRange`. If `PointList` is specified by `GridConnectivity_t`, then `PointListSize` is actually a user input during creation of the database; it is the length of the array `PointList` whose elements are also user inputs (by “user” we mean the application code that is generating the CGNS database).

By definition, the `PointList` and `PointListDonor` arrays have the same size, and this size should be stored along with the arrays in their respective `IndexArray_t` structures. `PointListSize` was chosen to be a structure function, rather than a separate element of `GridConnectivity_t` for the following reasons: first, it is redundant if `PointRange` is specified; and second, it leads to redundant storage if `PointList` is specified, since the value of `PointListSize` is also stored within the `PointList` structure.

This situation has somewhat of a precedent within the SIDS definitions. The structure `Descriptor_t` contains a string of unspecified length. Yet in actual implementation, the (string) length is a function of the descriptor string itself and should be stored along with the string.

8.5 General Interface Connectivity Examples

Example 8-C: Structured Abutting Zones

Say that you have a three-dimensional structured grid. Assume that at the interface between two zones you have the situation shown in Figure 6.

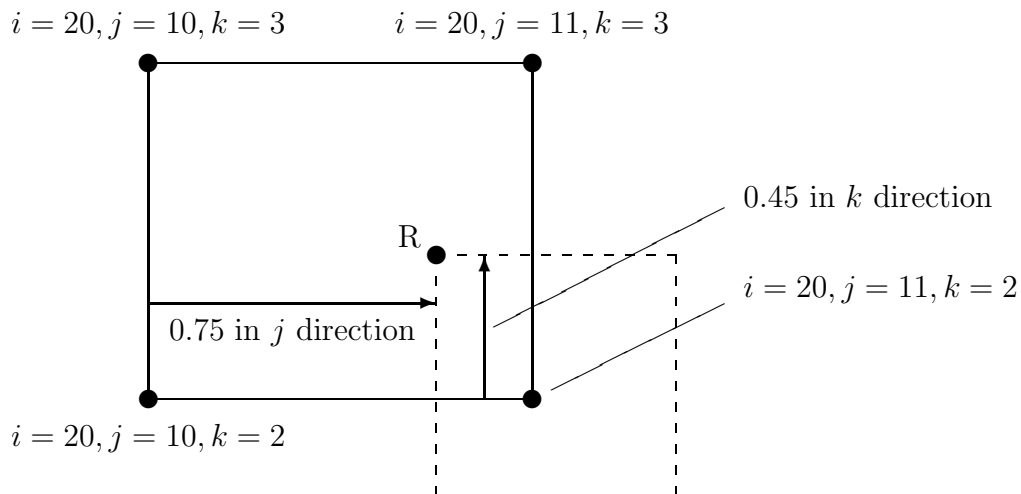

Figure 6: Example Interface for Generalized Connectivity, Structured Grids

In this particular example, the patching occurs on a “plane”. In other words, the two cells in 3-D have faces that abut in a 2-D sense. It is these faces that we are picturing here. The solid quadrilateral is the donor cell face, and the dashed quadrilateral is the position of the receiving cell face relative to the donor cell. Note that since this is a 2-D-type of abutting case, one of the

indices (in this case $i = 20$, which represents imax) of the donor cell is constant. For this example, the point R of the receiver cell is located within the donor cell pictured, and we wish to give the `CellListDonor` and `InterpolantsDonor` for it.

Because this is a structured grid, the `CellListDonor` in this case is given by

```
CellListDonor = (19, 10, 2)
```

Here, we are using the “Structured Grid Notation and Indexing Conventions” (see [Section 3.2](#)) that say cell centers, face centers, and edge centers are indexed by the minimum i , j , and k indices of the connecting vertices.

The `InterpolantsDonor` defines an interpolation value relative to the cell/element vertices. In this case, say that the point R is located 0.75 along the j -index direction and 0.45 along the k -index direction. (It also lies on the $i = 20$, or imax face.) Thus, in this example:

```
InterpolantsDonor = (1.0, 0.75, 0.45)
```

Note that if the donor zone was instead located on an $i = 1$ (imin face), then the `CellListDonor` would be (1, 10, 2) and the `InterpolantsDonor` would be (0.0, 0.75, 0.45).

Example 8-D: Unstructured Abutting Zones, HEXA_8 Donor Cell

As a second example, assume that you have the same setup as before, but now with a three-dimensional unstructured grid, shown in [Figure 7](#). In this case, we no longer have a 3-D array of indices defining coordinate directions. Instead, we simply have a 1-D list of indices as well as a list of volume (and possibly face) elements composed of those indices. In this example we again are assuming the two zones abut in a 2-D sense. We now have the choice of describing the donor in terms of its volume element or its boundary (face) element, if available. Here in this example, we use the volume element.

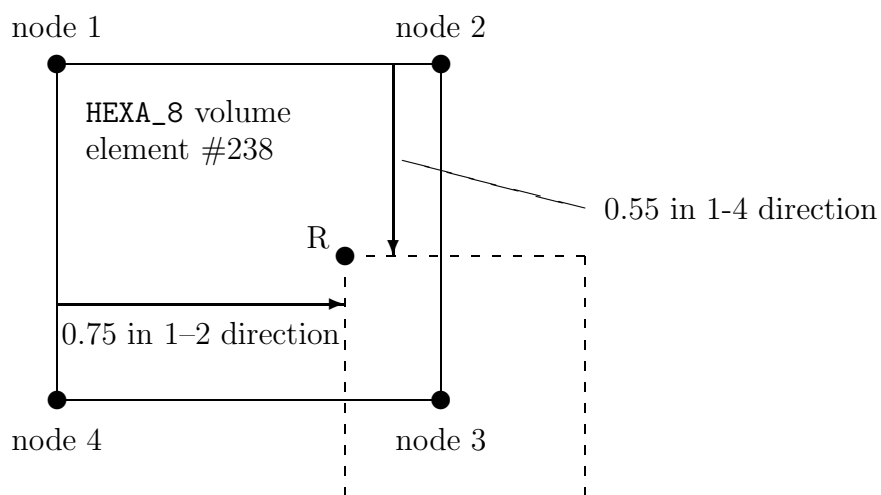

Figure 7: Example Interface for Generalized Connectivity, Unstructured Grids with HEXA_8 Donor Cell

The `HEXA_8` volume element has been appropriately numbered, using the “Unstructured Grid Element Numbering Conventions” defined in [Section 3.3](#). In this example, it is the 1-2-3-4 face of the volumetric element that is abutting with the other zone (but it could be any of its six faces)

The `CellListDonor` in this case is simply given by

```
CellListDonor = (238)
```

Using the convention established above for `HEXA_8` elements, the `InterpolantsDonor` would be

```
InterpolantsDonor = (0.75, 0.55, 0.0)
```

Example 8-E: Unstructured Abutting Zones, `TRI_3` Donor Cell

As a third example, assume that you have two zones in a three-dimensional unstructured grid with triangles and quadrilaterals at its boundaries, as shown in [Figure 8](#). Here the current zone (made up of quadrilateral faces) is abutting the donor zone (made up of triangular faces) in a 2-D sense. We again have the choice of describing the donor in terms of its volume element or its boundary (face) element. Here in this example, we use the face element.

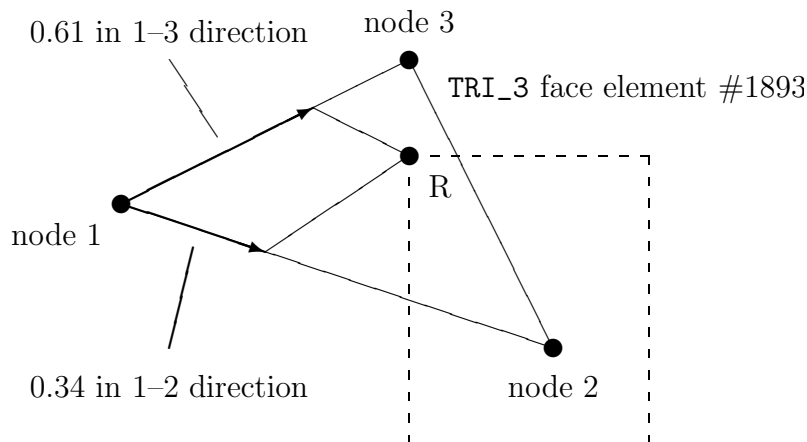

Figure 8: Example Interface for Generalized Connectivity, Unstructured Grids with `TRI_3` Donor Cell

The `CellListDonor` in this case is simply given by

```
CellListDonor = (1893)
```

Using the convention established above for `TRI_3` elements, the `InterpolantsDonor` would be:

```
InterpolantsDonor = (0.34, 0.61)
```

In this case the third dimension of the `InterpolantsDonor` (although present) is not used, because by default the interpolation is only two-dimensional in the 2-D plane of the donor face.

8.6 Grid Connectivity Property Structure Definition: GridConnectivityProperty_t

GridConnectivityProperty_t allows the recording of special properties associated with particular connectivity patches. At the current time, only two properties (Periodic_t and AverageInterface_t) are included, but extensions involving other properties may be implemented as additional nodes under GridConnectivityProperty_t in the future.

```
GridConnectivityProperty_t :=
{
  List( Descriptor_t Descriptor1 ... DescriptorN ) ;           (o)

  Periodic_t Periodic ;                                       (o)

  AverageInterface_t AverageInterface ;                       (o)

  List( UserDefinedData_t UserDefinedData1 ... UserDefinedDataN ) ; (o)
} ;
```

Notes

1. Default names for the Descriptor_t and UserDefinedData_t lists are as shown; users may choose other legitimate names. Legitimate names must be unique within a given instance of GridConnectivityProperty_t and shall not include the names Periodic or AverageInterface.

The Periodic_t and AverageInterface_t data structures may be used to record properties associated with periodic interfaces, or interfaces where data is to be averaged in some way, respectively.

The UserDefinedData_t data structure allows arbitrary user-defined data to be stored in Descriptor_t and DataArray_t children without the restrictions or implicit meanings imposed on these node types at other node locations.

8.6.1 Periodic Interface Structure Definition: Periodic_t

The Periodic_t data structure allows data associated with a periodic interface to be recorded.

```
Periodic_t :=
{
  List( Descriptor_t Descriptor1 ... DescriptorN ) ;           (o)

  DataArray_t<real, 1, PhysicalDimension> RotationCenter ;    (r)
  DataArray_t<real, 1, PhysicalDimension> RotationAngle ;     (r)
  DataArray_t<real, 1, PhysicalDimension> Translation ;       (r)
}
```

```

DataClass_t DataClass ; (o)

DimensionalUnits_t DimensionalUnits ; (o)

List( UserDefinedData_t UserDefinedData1 ... UserDefinedDataN ) ; (o)
} ;

```

Notes

1. Default names for the `Descriptor_t` and `UserDefinedData_t` lists are as shown; users may choose other legitimate names. Legitimate names must be unique within a given instance of `Periodic_t` and shall not include the names `DataClass`, `DimensionalUnits`, `RotationAngle`, `RotationCenter`, or `Translation`.

`RotationCenter` is the origin for defining the rotation angle between the periodic interfaces. `RotationAngle` defines the angle from the current interface to the connecting interface. If rotating about more than one axis, the rotation is performed first about the x -axis, then the y -axis, then the z -axis. `Translation` defines the translation from the current interface to the connecting interface.

`DataClass` defines the default for the class of data contained in the `DataArray_t` structures. If the data is dimensional, `DimensionalUnits` may be used to describe the system of dimensional units employed. If present, these two entities take precedence over all corresponding entities at higher levels of the hierarchy. These precedence rules are further discussed in [Section 6.4](#).

The `UserDefinedData_t` data structure allows arbitrary user-defined data to be stored in `Descriptor_t` and `DataArray_t` children without the restrictions or implicit meanings imposed on these node types at other node locations.

8.6.2 Average Interface Structure Definition: `AverageInterface_t`

The `AverageInterface_t` data structure is used when data at the current connectivity interface is to be averaged in some way prior to passing it to a neighboring interface.

```

AverageInterface_t :=
{
List( Descriptor_t Descriptor1 ... DescriptorN ) ; (o)

AverageInterfaceType_t AverageInterfaceType ; (r)

List( UserDefinedData_t UserDefinedData1 ... UserDefinedDataN ) ; (o)
} ;

```

Notes

1. Default names for the `Descriptor_t` and `UserDefinedData_t` lists are as shown; users may choose other legitimate names. Legitimate names must be unique within a given instance of `AverageInterface_t` and shall not include the name `AverageInterfaceType`.

`AverageInterfaceType_t` is a required enumeration data structure that is used to define the type of averaging to be done.

```
AverageInterfaceType_t := Enumeration(  
    AverageInterfaceTypeNull,  
    AverageInterfaceTypeUserDefined,  
    AverageAll,  
    AverageCircumferential,  
    AverageRadial,  
    AverageI,  
    AverageJ,  
    AverageK ) ;
```

`AverageAll` means that the data from the entire current patch is averaged, whereas each of the other choices indicates averaging of the data on the current interface in the indicated direction. Note that `AverageI`, `AverageJ`, and `AverageK` apply only to structured grids.

The `UserDefinedData_t` data structure allows arbitrary user-defined data to be stored in `Descriptor_t` and `DataArray_t` children without the restrictions or implicit meanings imposed on these node types at other node locations.

8.7 Overset Grid Holes Structure Definition: `OversetHoles_t`

Grid connectivity for overset grids must also include “holes” within zones, where any solution states are ignored or “turned off”, because they are solved for in some other overlapping zone. The structure `OversetHoles_t` specifies those points within a given zone that make up a hole (or holes), and applies to both structured and unstructured zones. Grid points specified in this structure are equivalent to those with `IBLANK=0` in the `PLOT3D` format.

```
OversetHoles_t< int IndexDimension > :=  
    {  
        List( Descriptor_t Descriptor1 ... DescriptorN ) ;           (o)  
  
        GridLocation_t GridLocation ;                               (o/d)  
  
        List( IndexRange_t<IndexDimension>  
            PointRange, PointRange2 ... PointRangeN ) ;           (o:r)  
  
        IndexArray_t<IndexDimension, PointListSize, int> PointList ; (r:o)  
  
        List( UserDefinedData_t UserDefinedData1 ... UserDefinedDataN ) ; (o)  
    } ;
```

Notes

1. Default names for the `Descriptor_t`, `IndexRange_t`, and `UserDefinedData_t` lists are as shown; users may choose other legitimate names. Legitimate names must be unique within a given instance of `OversetHoles_t` and shall not include the names `GridLocation` or `PointList`.
2. If `GridLocation` is absent, then its default value is `Vertex`.
3. One of `PointRange` and `PointList` must be specified, but not both.

The location of grid indices specified in `PointList` and the `PointRange` list is given by `GridLocation`.

The grid points making up a hole within a zone may be specified by `PointRange` if they constitute a logically rectangular region. If the hole points constitute a (small) set of possibly overlapping logically rectangular regions, then they may be specified by the list `PointRange`, `PointRange2`, etc. The more general alternate is to use `PointList` to list all grid points making up the hole(s) within a zone. Note that using multiple `PointRange` specifications may result in a given hole being specified more than once.

The `UserDefinedData_t` data structure allows arbitrary user-defined data to be stored in `Descriptor_t` and `DataArray_t` children without the restrictions or implicit meanings imposed on these node types at other node locations.

FUNCTION `PointListSize`:

return value: `int`

dependencies: `PointList`

`OversetHoles_t` requires one structure function, `PointListSize`, to identify the length of the `PointList` array. `PointListSize` is a user input. (See the discussion on function `PointListSize` in [Section 8.4](#)).

9 Boundary Conditions

This section is an attempt to unify boundary-condition specifications within Navier-Stokes codes. The structures and conventions developed are a compromise between simplicity and generality. It is imperative that they be easy to use initially, but that they are general enough to provide future flexibility and extensibility.

This section may be somewhat daunting initially. It is suggested that the reader refer to the several, well-explained examples presented in [Section 9.10](#) during study of the following sections to help resolve any questions and confusions that might arise.

The difficulty with boundary conditions is that there is such a wide variety used, and even a single boundary-condition equation is often implemented differently in different codes. Some boundary conditions, such as a symmetry plane, are fairly well defined. Other boundary conditions are much looser in their definition and implementation. An inflow boundary is a good example. It is generally accepted how many solution quantities should be specified at an inflow boundary (from mathematical well-posedness arguments), but what those quantities are will change with the class of flow problems (e.g., internal flows vs. external flows), and they will also change from code to code.

An additional difficulty for CFD analysis is that in some situations different boundary-condition equations are applied depending on local flow conditions. Any boundary where the flow can change from inflow to outflow or supersonic to subsonic is a candidate for flow-dependent boundary-condition equations.

These difficulties have molded the design of our boundary-condition specification structures and conventions. We define boundary-condition types ([Section 9.7](#)) that establish the equations to be enforced. However, for those more loosely defined boundary conditions, such as inflow/outflow, the boundary-condition type merely establishes general guidelines on the equations to be imposed. Augmenting (and superseding) the information provided by the boundary-condition type is precisely defined boundary-condition solution data. We rely on our conventions for data-name identifiers to identify the exact quantities involved in the boundary conditions; these data-name identifier conventions are presented in [Appendix A](#).

One flexibility that is provided by this approach is that boundary-condition information can easily be built during the course of an analysis. For example, during grid-generation phases minimal information (e.g., the boundary-condition type) may be given. Then prior to running of the flow solver, more specific boundary-condition information, such as Dirichlet or Neumann data, may be added to the database.

An additional flexibility provided by the structures of this section is that both uniform and non-uniform boundary-condition data can be described within the same framework.

We realize that most current codes allow little or no flexibility in choosing solution quantities to specify for a given boundary-condition type. We also realize the coding effort involved with checking for consistency between I/O specifications and internal boundary-condition routines. To make these boundary-condition structures more palatable initially, we adopt the convention that if no solution quantities are specified for a given boundary-condition type, then the code is free to enforce any appropriate boundary condition (see [Section 9.9](#)).

Note that there are no boundary-condition structures defined for abutting or overset interfaces, unless they involve cases of symmetry or degeneracy. In other words, it is a CGNS design intent that a given zone boundary segment or location should at most be defined (or covered) by either a boundary condition or a multizone interface connectivity, but not by both. There is also no separate boundary-condition structure for periodic boundary conditions (i.e., when a zone interfaces with itself). Both of these situations are addressed by the interface connectivity data structures described in [Section 8](#).

In the sections to follow, the definitions of boundary-condition structures are first presented in [Section 9.1](#) through [Section 9.6](#). Boundary-condition types are then discussed in detail in [Section 9.7](#), including a description of the boundary-condition equations to be enforced for each type; this section also describes the distinction between boundary-condition types that impose a set of equations regardless of local flow conditions and those that impose different sets of boundary-condition equations depending on the local flow solution. The rules for matching boundary-condition types and the appropriate sets of boundary-condition equations are next discussed in [Section 9.8](#). Details of specifying data to be imposed in boundary-condition equations are provided in [Section 9.9](#). Finally, [Section 9.10](#) presents several examples of boundary conditions.

9.1 Boundary Condition Structures Overview

Prior to presenting the detailed boundary condition structures, we give a brief overview of the hierarchy used to describe boundary conditions.

Boundary conditions are classified as either fixed or flow-dependent. Fixed boundary conditions enforce a given set of boundary-condition equations regardless of flow conditions; whereas, flow-dependent boundary conditions enforce different sets of boundary-condition equations depending on local flow conditions. We incorporate both fixed and flow-dependent boundary conditions into a uniform framework. This allows all boundary conditions to be described in a similar manner. We consider this functionally superior to separately treating fixed and flow-dependent boundary conditions, even though the latter allows a simpler description mechanism for fixed boundary conditions. The current organization also makes sense considering the fact that flow-dependent boundary conditions are composed of multiple sets of fixed boundary conditions.

[Figure 9](#) depicts the hierarchy used for prescribing a single boundary condition. Each boundary condition includes a type that describes the general equations to enforce, a patch specification, and a collection of data sets. The minimum required information for any boundary condition is the patch specification and the boundary-condition type (indicated by “BC type (compound)” in the figure). This minimum information is similar to that used in many existing flow solvers.

Generality in prescribing equations to enforce and their associated boundary-condition data is provided in the optional data sets. Each data set contains all boundary condition data required for a given fixed or simple boundary condition. Each data set is also tagged with a boundary-condition type. For fixed boundary conditions, the hierarchical tree contains a single data set, and the two boundary-condition types shown in [Figure 9](#) are identical. Flow-dependent or compound boundary conditions contain multiple data sets, each to be applied separately depending on local flow conditions. The compound boundary-condition type describes the general flow-dependent boundary conditions, and each data set contains associated simple boundary-condition types. For

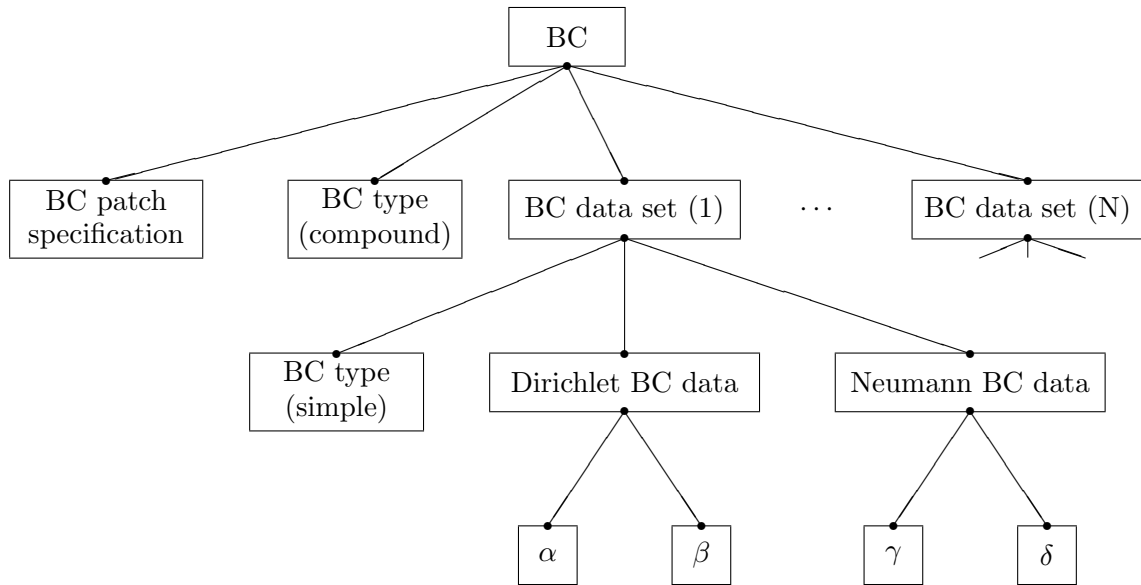

Figure 9: Hierarchy for Boundary Condition Structures

example, a farfield boundary condition would contain four data sets, where each applies to the different combinations of subsonic and supersonic inflow and outflow. Boundary-condition types are described in [Section 9.7](#) and [Section 9.8](#).

Within a single data set, boundary condition data is grouped by equation type into Dirichlet and Neumann data. The lower leaves of [Figure 9](#) show data for generic flow-solution quantities α and β to be applied in Dirichlet conditions, and data for γ and δ to be applied in Neumann boundary conditions. `DataArray_t` entities are employed to store these data and to identify the specific flow variables they are associated with.

In situations where the data sets (or any information contained therein) are absent from a given boundary-condition hierarchy, flow solvers are free to impose any appropriate boundary conditions. Although not pictured in [Figure 9](#), it is also possible to specify the reference state from which the flow solver should extract the boundary-condition data.

9.2 Zonal Boundary Condition Structure Definition: `ZoneBC_t`

All boundary-condition information pertaining to a given zone is contained in the `ZoneBC_t` structure.

```

ZoneBC_t< int CellDimension, int IndexDimension, int PhysicalDimension > :=
{
  List( Descriptor_t Descriptor1 ... DescriptorN ) ;           (o)

  List( BC_t<CellDimension, IndexDimension, int PhysicalDimension>
        BC1 ... BCN ) ;                                     (o)

```

```
ReferenceState_t ReferenceState ; (o)

DataClass_t DataClass ; (o)

DimensionalUnits_t DimensionalUnits ; (o)

List( UserDefinedData_t UserDefinedData1 ... UserDefinedDataN ) ; (o)
} ;
```

Notes

1. Default names for the `Descriptor_t`, `BC_t`, and `UserDefinedData_t` lists are as shown; users may choose other legitimate names. Legitimate names must be unique within a given instance of `ZoneBC_t` and shall not include the names `DataClass`, `DimensionalUnits`, or `ReferenceState`.
2. All lists within a `ZoneBC_t` structure entity may be empty.

`ZoneBC_t` requires three structure parameters, `CellDimension`, `IndexDimension` and `PhysicalDimension`, which are passed onto all `BC_t` substructures.

Boundary-condition information for a single patch is contained in the `BC_t` structure. All boundary-condition information pertaining to a given zone is contained in the list of `BC_t` structure entities. If a zone contains N boundary-condition patches, then N (and only N) separate instances of `BC_t` must be provided in the `ZoneBC_t` entity for the zone. That is, each boundary-condition patch must be represented by a single `BC_t` entity.

Reference data applicable to all boundary conditions of a zone is contained in the `ReferenceState` structure. `DataClass` defines the zonal default for the class of data contained in the boundary conditions of a zone. If the boundary conditions contain dimensional data, `DimensionalUnits` may be used to describe the system of dimensional units employed. If present, these three entities take precedence over all corresponding entities at higher levels of the hierarchy. These precedence rules are further discussed in [Section 6.4](#).

Reference-state data is useful for situations where boundary-condition data is not provided, and flow solvers are free to enforce any appropriate boundary condition equations. The presence of `ReferenceState` at this level or below specifies the appropriate flow conditions from which the flow solver should extract its boundary-condition data. For example, when computing an external flowfield around an airplane, an engine nozzle exit is often simulated by imposing a stagnation pressure boundary condition (or some other stagnation quantity) different from freestream. The nozzle-exit stagnation quantities could be specified in an instance of `ReferenceState` at this level or below in lieu of providing explicit Dirichlet or Neumann data (see [Section 9.9](#)).

The `UserDefinedData_t` data structure allows arbitrary user-defined data to be stored in `Descriptor_t` and `DataArray_t` children without the restrictions or implicit meanings imposed on these node types at other node locations.

9.3 Boundary Condition Structure Definition: BC_t

BC_t contains boundary-condition information for a single BC surface patch of a zone. A BC patch is the subrange of the face of a zone where a given boundary condition is applied.

The structure contains a boundary-condition type, as well as one or more sets of boundary-condition data that are used to define the boundary-condition equations to be enforced on the BC patch. For most boundary conditions, a single data set is all that is needed. The structure also contains information describing the normal vector to the BC surface patch.

```

BC_t< int CellDimension, int IndexDimension, int PhysicalDimension > :=
{
  List( Descriptor_t Descriptor1 ... DescriptorN ) ;           (o)

  BCType_t BCType ;                                         (r)

  GridLocation_t GridLocation ;                             (o/d)

  IndexRange_t<IndexDimension> PointRange ;                 (r:o)
  IndexArray_t<IndexDimension, ListLength[], int> PointList ; (o:r)

  int[IndexDimension] InwardNormalIndex ;                  (o)

  IndexArray_t<PhysicalDimension, ListLength[], real> InwardNormalList ; (o)

  List( BCDataSet_t<CellDimension, IndexDimension, ListLength[],
        GridLocation> BCDataSet1 ... BCDataSetN ) ;       (o)

  BCProperty_t BCProperty ;                                (o)

  FamilyName_t FamilyName ;                                (o)

  List( AdditionalFamilyName_t AddFamilyName1 ... AddFamilyNameN ) ; (o)

  ReferenceState_t ReferenceState ;                         (o)

  DataClass_t DataClass ;                                   (o)

  DimensionalUnits_t DimensionalUnits ;                    (o)

  List( UserDefinedData_t UserDefinedData1 ... UserDefinedDataN ) ; (o)

  int Ordinal ;                                           (o)
} ;

```

Notes

1. Default names for the `Descriptor_t`, `BCDataSet_t`, and `UserDefinedData_t` lists are as shown; users may choose other legitimate names. Legitimate names must be unique within a given instance of `BC_t` and shall not include the names `BCProperty`, `BCType`, `DataClass`, `DimensionalUnits`, `FamilyName`, `GridLocation`, `InwardNormalIndex`, `InwardNormalList`, `Ordinal`, `PointList`, `PointRange` or `ReferenceState`.
2. `GridLocation` is optional; if absent its default value is `Vertex`. For other allowable values, see the table below.
3. One of `PointRange` or `PointList` must be specified but not both. They must define a face subrange of the zone.
4. `InwardNormalIndex` is only an option for structured grids. For unstructured grid boundaries, it should not be used. `InwardNormalIndex` may have only one nonzero element, whose sign indicates the computational-coordinate direction of the BC patch normal; this normal points into the interior of the zone.
5. `InwardNormalList` contains a list of vectors normal to the BC patch pointing into the interior of the zone. It is a function of `PhysicalDimension` and `ListLength[]`. The vectors are located at the vertices of the BC patch when `GridLocation` is set to `Vertex`. Otherwise, they are located at edge/face midpoints. The vectors are not required to have unit magnitude.
6. If `PointRange` and `InwardNormalList` are specified, an ordering convention is needed for indices on the BC patch. An ordering convention is also needed if a range is specified and local data is present in the `BCDataSet_t` substructures. FORTRAN multidimensional array ordering is used.

`BCType` specifies the boundary-condition type, which gives general information on the boundary-condition equations to be enforced.

The BC patch may be specified by `PointRange` if it constitutes a logically rectangular region. In all other cases, `PointList` should be used to list the vertices or cell edges/faces making up the BC patch. When `GridLocation` is set to `Vertex`, then `PointList` or `PointRange` refer to vertex indices, for both structured and unstructured grids. When `GridLocation` is set to `EdgeCenter`, then `PointRange/List` refer to edge elements. For 3-D grids, when `GridLocation` is set to `FaceCenter`, `IFaceCenter`, etc., then `PointRange/List` refer to face elements. The interpretation of `PointRange/List` is summarized in [Table 6](#).

Table 6: GridLocation Usage with BC Patches

CellDimension	GridLocation			
	Vertex	EdgeCenter	*FaceCenter	CellCenter
1	vertices	—	—	cells (line elements)
2	vertices	edges	—	cells (area elements)
3	vertices	edges	faces	cells (volume elements)

Note: In the table, `*FaceCenter` stands for the possible types: `FaceCenter`, `IFaceCenter`, `JFaceCenter` or `KFaceCenter`.

For structured grids, face centers are indexed using the minimum of the connecting vertex indices,

as described in [Section 3.2](#). For unstructured grids, edge and face elements are indexed using their element numbering as defined in the `Elements_t` data structures.

The BC patch defined by `PointRange/List` is a surface region over which the particular set of boundary conditions is applied. However, in the current standard there is no mechanism to specify whether boundary conditions are enforced in the weak or strong form. If boundary conditions are imposed using collocation (i.e., strong form), there is also no requirement that they be imposed at the same locations used to define the BC patch (via `PointRange/List`). In the case when BC patches are defined in terms of vertices (or edges in 3-D), then the bounding vertices will be located on multiple BC patches. If boundary conditions are imposed using collocation at vertices, then for this case there is no mechanism to determine which BC patch takes precedence for any of these bounding vertices.

Some boundary conditions require a normal direction to be specified in order to be properly imposed. For structured zones a computational-coordinate normal can be derived from the BC patch specification by examining redundant index components. Alternatively, for structured zones this information can be provided directly by `InwardNormalIndex`. From Note 4, this vector points into the zone and can have only one non-zero element. For exterior faces of a zone in 3-D, `InwardNormalIndex` should take the following values:

Face	InwardNormalIndex	Face	InwardNormalIndex
<i>i</i> -min	[+1, 0, 0]	<i>i</i> -max	[-1, 0, 0]
<i>j</i> -min	[0, +1, 0]	<i>j</i> -max	[0, -1, 0]
<i>k</i> -min	[0, 0, +1]	<i>k</i> -max	[0, 0, -1]

The physical-space normal vectors of the BC patch may be described by `InwardNormalList`; these are located at vertices or cell faces, consistent with the BC patch specification. `InwardNormalList` is listed as an optional field because it is not always needed to enforce boundary conditions, and the physical-space normals of a BC patch can usually be constructed from the grid. However, there are some situations, such as grid-coordinate singularity lines, where `InwardNormalList` becomes a required field, because it cannot be generated from other information.

The `BC_t` structure provides for a list of boundary-condition data sets, described in the next section. In general, the proper `BCDataSet_t` instance to impose on the BC patch is determined by the `BCType` association table ([Table 9](#) on p. 159). The mechanics of determining the proper data set to impose is described in [Section 9.8](#).

For a few boundary conditions, such as a symmetry plane or polar singularity, the value of `BCType` completely describes the equations to impose, and no instances of `BCDataSet_t` are needed. For “simple” boundary conditions, where a single set of Dirichlet and/or Neumann data is applied, a single `BCDataSet_t` will likely appear (although this is not a requirement). For “compound” boundary conditions, where the equations to impose are dependent on local flow conditions, several instances of `BCDataSet_t` will likely appear; the procedure for choosing the proper data set is more complex as described in [Section 9.8](#).

A `BCProperty_t` data structure, described in [Section 9.6](#), may be used to record special properties associated with particular boundary condition patches, such as wall functions or bleed regions.

`FamilyName` identifies the family to which the boundary belongs. Family names link the mesh boundaries to the CAD surfaces. (See [Section 12.6](#).) Boundary conditions may also be defined directly on families. In this case, the `BCType` must be `FamilySpecified`. If, under a `BC_t` structure, both `FamilyName_t` and `BCType_t` are present, and the `BCType` is *not* `FamilySpecified`, then the `BCType` that *is* specified takes precedence over any `BCType` that might be stored in a `FamilyBC_t` structure under the specified `Family_t`. The actual name of the referred-to `Family_t` can be in the same base or another base, as detailed in [Section 6.2.1](#).

Reference data applicable to the boundary conditions of a BC patch is contained in the `ReferenceState` structure. `DataClass` defines the default for the class of data contained in the boundary conditions. If the boundary conditions contain dimensional data, `DimensionalUnits` may be used to describe the system of dimensional units employed. If present, these three entities take precedence over all corresponding entities at higher levels of the hierarchy. These precedence rules are further discussed in [Section 6.4](#).

The `UserDefinedData_t` data structure allows arbitrary user-defined data to be stored in `Descriptor_t` and `DataArray_t` children without the restrictions or implicit meanings imposed on these node types at other node locations.

`Ordinal` is user-defined and has no restrictions on the values that it can contain. It is included for backward compatibility to assist implementation of the CGNS system into applications whose I/O depends heavily on the numbering of BC patches. Since there are no restrictions on the values contained in `Ordinal` (or that `Ordinal` is even provided), there is no guarantee that the BC patches for a given zone in an existing CGNS database will have sequential values from 1 to N without holes or repetitions. Use of `Ordinal` is discouraged and is on a user-beware basis.

FUNCTION `ListLength[]`:

return value: `int`

dependencies: `PointRange`, `PointList`

`BC_t` requires the structure function `ListLength`, which is used to specify the number of vertices or edge/face elements making up the BC patch. If `PointRange` is specified, then `ListLength` is obtained from the number of points (inclusive) between the beginning and ending indices of `PointRange`. If `PointList` is specified, then `ListLength` is the number of indices in the list of points. In this situation, `ListLength` becomes a user input along with the indices of the list `PointList`. By “user” we mean the application code that is generating the CGNS database. If `ElementRange` or `ElementList` is specified, then `ListLength` is defined by the cell faces making up the BC patch.

`ListLength` is also the number of elements in the list `InwardNormalList`. Note that syntactically `PointList` and `InwardNormalList` must have the same number of elements.

If neither `PointRange` or `PointList` is specified in a particular `BCDataSet_t` substructure, `ListLength` must be passed into it to determine the length of BC data arrays.

9.4 Boundary Condition Data Set Structure Definition: BCDataSet_t

BCDataSet_t contains Dirichlet and Neumann data for a single set of boundary-condition equations. Its intended use is for simple boundary-condition types, where the equations imposed do not depend on local flow conditions.

```

BCDataSet_t< int CellDimension, int IndexDimension, int ListLengthParameter,
             GridLocation_t GridLocationParameter > :=
{
List( Descriptor_t Descriptor1 ... DescriptorN ) ;           (o)

BCTypeSimple_t BCTypeSimple ;                               (r)

BCData_t<ListLengthBCData[]> DirichletData ;                (o)
BCData_t<ListLengthBCData[]> NeumannData ;                 (o)

GridLocation_t GridLocation ;                               (o/d)

IndexRange_t<IndexDimension> PointRange ;                  (o)
IndexArray_t<IndexDimension, ListLength, int> PointList ;  (o)

ReferenceState_t ReferenceState ;                          (o)

DataClass_t DataClass ;                                    (o)

DimensionalUnits_t DimensionalUnits ;                      (o)

List( UserDefinedData_t UserDefinedData1 ... UserDefinedDataN ) ; (o)
} ;

```

Notes

1. Default names for the `Descriptor_t` and `UserDefinedData_t` lists are as shown; users may choose other legitimate names. Legitimate names must be unique within a given instance of `BCDataSet_t` and shall not include the names `BCTypeSimple`, `DataClass`, `DimensionalUnits`, `DirichletData`, `GridLocation`, `NeumannData`, `PointList`, `PointRange`, or `ReferenceState`.
2. `BCTypeSimple` is the only required field. All other fields are optional and the `Descriptor_t` list may be empty.
3. `GridLocation` is optional; if absent its default value is `GridLocationParameter`. For 2-D grids (`CellDimension = 2`), `GridLocation` may take the values of `Vertex` or `EdgeCenter`. For 3-D grids (`CellDimension = 3`), `GridLocation` may take the values of `Vertex`, `EdgeCenter`, `FaceCenter`, `IFaceCenter`, `JFaceCenter` or `KFaceCenter`.
4. `PointRange` and `PointList` are both optional; only one of them may be specified. They must define a face subrange of the zone.

`BCDataSet_t` requires the structure parameters `CellDimension`, `IndexDimension`, `ListLengthParameter` and `GridLocationParameter`. These are all used to control the grid location and length of data arrays in the `Dirichlet` and `Neumann` substructures. They are inputs for the structure functions `ListLength[]` and `ListLengthBCData[]` defined below.

`BCTypeSimple` specifies the boundary-condition type, which gives general information on the boundary-condition equations to be enforced. `BCTypeSimple_t` is defined in [Section 9.7](#) along with the meanings of all the `BCTypeSimple` values. `BCTypeSimple` is also used for matching boundary condition data sets as discussed in [Section 9.8](#).

Boundary-condition data is separated by equation type into `Dirichlet` and `Neumann` conditions. `Dirichlet` boundary conditions impose the value of the given variables, whereas `Neumann` boundary conditions impose the normal derivative of the given variables. The mechanics of specifying `Dirichlet` and `Neumann` data for boundary conditions is covered in [Section 9.9](#).

The substructures `DirichletData` and `NeumannData` contain boundary-condition data that may be constant over the BC patch or defined locally at each vertex or edge/face of the patch. Locally defined data can be specified in one of two ways. If `GridLocation`, `PointRange` and `PointList` are all absent, then the data is defined consistent with the BC patch specification of the parent `BC_t` structure. In this case, the location of the locally defined data is given by `GridLocationParameter` and the length of the data arrays are given by `ListLengthParameter`. If `GridLocation` and one of `PointRange` or `PointList` is present, then the same rules provided in [Section 9.3](#) apply. In this case, the length of the data arrays is given by `ListLength[]`.

Reference quantities applicable to the set of boundary-condition data are contained in the `ReferenceState` structure. `DataClass` defines the default for the class of data contained in the boundary-condition data. If the boundary conditions contain dimensional data, `DimensionalUnits` may be used to describe the system of dimensional units employed. If present, these three entities take precedence over all corresponding entities at higher levels of the hierarchy. These precedence rules are further discussed in [Section 6.4](#).

The `UserDefinedData_t` data structure allows arbitrary user-defined data to be stored in `Descriptor_t` and `DataArray_t` children without the restrictions or implicit meanings imposed on these node types at other node locations.

FUNCTION `ListLength[]`:

return value: `int`

dependencies: `PointRange`, `PointList`

`BCDataSet_t` requires the structure function `ListLength`, which is used to specify the length of locally defined `Dirichlet` and `Neumann` data arrays when the grid location of these quantities differs from that of the BC patch definition. The definition of `ListLength` is identical to that provided in `BC_t` ([Section 9.3](#)).

FUNCTION `ListLengthBCData[]`:

return value: `int`

dependencies: `ListLengthParameter`, `PointRange`, `PointList`

`BCDataSet_t` also requires the structure function `ListLengthBCData`. If `PointRange` or `PointList` is present, then `ListLengthBCData` takes the value of `ListLength`. If both are absent, then it takes the value `ListLengthParameter`.

9.5 Boundary Condition Data Structure Definition: `BCData_t`

`BCData_t` contains a list of variables and associated data for boundary-condition specification. Each variable may be given as global data (i.e., a scalar) or local data defined at each grid point or cell face of the BC patch. By convention all data specified in a given instance of `BCData_t` is to be used in the same *type* of boundary-condition equation. For example, the use of separate `BCData_t` substructures for Dirichlet and Neumann equations in the `BCDataSet_t` structure of the previous section.

```

BCData_t< int ListLength > :=
{
  List( Descriptor_t Descriptor1 ... DescriptorN ) ;           (o)

  List( DataArray_t<DataType, 1, 1>
        DataGlobal1 ... DataGlobalN ) ;                       (o)

  List( DataArray_t<DataType, 1, ListLength>
        DataLocal1 ... DataLocalN ) ;                         (o)

  DataClass_t DataClass ;                                     (o)

  DimensionalUnits_t DimensionalUnits ;                       (o)

  List( UserDefinedData_t UserDefinedData1 ... UserDefinedDataN ) ; (o)
} ;

```

Notes

1. Default names for the `Descriptor_t`, `DataArray_t`, and `UserDefinedData_t` lists are as shown; users may choose other legitimate names. Legitimate names must be unique within a given instance of `BCData_t` and shall not include the names `DataClass` or `DimensionalUnits`.
2. There are no required elements; all three lists may be empty.

This structure definition shows separate lists for global verses local data. The global data is essentially scalars, while the local data variables have size determined by the structure parameter `ListLength`. For `DataArray_t` entities with standardized data-name identifiers listed in [Appendix A](#), `DataType` is determined by convention. For user-defined variables, `DataType` is a user input.

Two important points need to be mentioned regarding this structure definition. First, this definition allows a given instance of `BCData_t` to have a mixture of global and local data. For example,

if a user specifies Dirichlet data that has a uniform stagnation pressure but has a non-uniform velocity profile, this structure allows the user to describe the stagnation pressure by a scalar in the `DataGlobal` list and the velocity by an array in the `DataLocal` list. Second, the only distinction between the lists (aside from default names, which will be seldom used) is the parameters passed into the `DataArray_t` structure. Therefore, in actual implementation of this `BCData_t` structure it may not be possible to distinguish between members of the global and local lists without querying inside the `DataArray_t` substructures. Straightforward mapping onto the ADF or HDF database will not provide any distinctions between the members of the two lists. This hopefully will not cause any problems.

`DataClass` defines the default for the class of data contained in the boundary-condition data. If the boundary-condition data is dimensional, `DimensionalUnits` may be used to describe the system of dimensional units employed. If present, these two entities take precedence over all corresponding entities at higher levels of the hierarchy. These precedence rules are further discussed in [Section 6.4](#).

The `UserDefinedData_t` data structure allows arbitrary user-defined data to be stored in `Descriptor_t` and `DataArray_t` children without the restrictions or implicit meanings imposed on these node types at other node locations.

9.6 Boundary Condition Property Structure Definition: `BCProperty_t`

`BCProperty_t` allows the recording of special properties associated with particular boundary condition patches. At the current time, only two properties (`WallFunction_t` and `Area_t`) are included, but extensions involving boundary conditions may be implemented as additional nodes under `BCProperty_t` in the future.

```
BCProperty_t :=
{
  List( Descriptor_t Descriptor1 ... DescriptorN ) ;           (o)

  WallFunction_t WallFunction ;                               (o)

  Area_t Area ;                                              (o)

  List( UserDefinedData_t UserDefinedData1 ... UserDefinedDataN ) ; (o)
} ;
```

Notes

1. Default names for the `Descriptor_t`, `DataArray_t`, and `UserDefinedData_t` lists are as shown; users may choose other legitimate names. Legitimate names must be unique within a given instance of `BCProperty_t` and shall not include the names `WallFunction` or `Area`.

The `WallFunction_t` and `Area_t` data structures may be used to record properties associated with the use of wall functions, or area-related boundary conditions such as bleed, respectively.

The `UserDefinedData_t` data structure allows arbitrary user-defined data to be stored in `Descriptor_t` and `DataArray_t` children without the restrictions or implicit meanings imposed on these node types at other node locations.

9.6.1 Wall Function Structure Definition: `WallFunction_t`

The `WallFunction_t` data structure allows data associated with the use of wall function boundary conditions to be recorded.

```
WallFunction_t :=
{
  List( Descriptor_t Descriptor1 ... DescriptorN ) ;           (o)

  WallFunctionType_t WallFunctionType ;                       (r)

  List( UserDefinedData_t UserDefinedData1 ... UserDefinedDataN ) ; (o)
} ;
```

Notes

1. Default names for the `Descriptor_t` and `UserDefinedData_t` lists are as shown; users may choose other legitimate names. Legitimate names must be unique within a given instance of `WallFunction_t` and shall not include the name `WallFunctionType`.

`WallFunctionType_t` is a required enumeration data structure that is used to define the type of wall functions being used.

```
WallFunctionType_t := Enumeration(
  WallFunctionTypeNull,
  WallFunctionTypeUserDefined,
  Generic ) ;
```

Because there is such a wide array of methods for employing wall functions (few of which are well-documented), the type `Generic` is used to simply indicate that a wall function is employed, without specifying details.

9.6.2 Area Structure Definition: `Area_t`

The `Area_t` data structure allows data associated with area-related boundary conditions such as bleed to be recorded.

```
Area_t :=
{
  List( Descriptor_t Descriptor1 ... DescriptorN ) ;           (o)
```

```
AreaType_t AreaType ; (r)
dataArray_t<real, 1, 1> SurfaceArea ; (r)
dataArray_t<real, 1, 32> RegionName ; (r)

List( UserDefinedData_t UserDefinedData1 ... UserDefinedDataN ) ; (o)
} ;
```

Notes

1. Default names for the `Descriptor_t` and `UserDefinedData_t` lists are as shown; users may choose other legitimate names. Legitimate names must be unique within a given instance of `Area_t` and shall not include the names `AreaType`, `RegionName`, or `SurfaceArea`.

`AreaType_t` is a required enumeration data structure that is used to define the type of area being defined.

```
AreaType_t := Enumeration(
  AreaTypeNull,
  AreaTypeUserDefined,
  BleedArea,
  CaptureArea ) ;
```

If `AreaType` is set to `BleedArea`, the value of `SurfaceArea` is the size of the current bleed surface. Note that bleed is commonly used with wall boundary conditions. The bleed area is the surface area of the boundary condition patch.

If `AreaType` is set to `CaptureArea`, then `SurfaceArea` represents the size of the current capture surface. For inlet flows, for example, the capture area is the area of a fictitious surface in front of the inlet in which mass is pulled into the inlet. This is used to calculate the mass flow for the boundary condition patch based on the formula:

$$mass\ flow = MFR \rho_{\infty} U_{\infty} A_{cap}$$

where MFR is the desired mass flow ratio and A_{cap} is the capture area. Another interpretation is the far-upstream cross-sectional area of the stream tube that feeds the inlet. Note that the capture area is usually defined with an outflow boundary condition, which is commonly used at an engine face.

The `RegionName` is character identifier, and is needed so that a specific region can span multiple surfaces over multiple zones.

9.7 Boundary Condition Type Structure Definition: `BCType_t`

`BCType_t` is an enumeration type that identifies the boundary-condition equations to be enforced at a given boundary location.

```

BCType_t := Enumeration(
  BCTypeNull, BCTypeUserDefined, BCAxisymmetricWedge, BCDegenerateLine.
  BCDegeneratePoint, BCDirichlet, BCExtrapolate, BCFarfield, BCGeneral,
  BCInflow, BCInflowSubsonic, BCInflowSupersonic, BCNeumann,
  BCOutflow, BCOutflowSubsonic, BCOutflowSupersonic, BCSymmetryPlane,
  BCSymmetryPolar, BCTunnelInflow, BCTunnelOutflow, BCWall,
  BCWallInviscid, BCWallViscous, BCWallViscousHeatFlux,
  BCWallViscousIsothermal, FamilySpecified ) ;

```

The boundary-condition type is further defined as simple, `BCTypeSimple_t`, or compound, `BCTypeCompound_t`, which are subsets of the enumeration type `BCType_t`.

```

BCTypeSimple_t := Enumeration(
  BCTypeNull, BCTypeUserDefined, BCAxisymmetricWedge, BCDegenerateLine.
  BCDegeneratePoint, BCDirichlet, BCExtrapolate, BCGeneral,
  BCInflowSubsonic, BCInflowSupersonic, BCNeumann,
  BCOutflowSubsonic, BCOutflowSupersonic, BCSymmetryPlane,
  BCSymmetryPolar, BCTunnelInflow, BCTunnelOutflow, BCWall,
  BCWallInviscid, BCWallViscous, BCWallViscousHeatFlux,
  BCWallViscousIsothermal, FamilySpecified ) ;

```

```

BCTypeCompound_t := Enumeration(
  BCTypeNull, BCTypeUserDefined, BCInflow, BCOutflow,
  BCFarfield ) ;

```

The members of `BCTypeSimple_t` completely identify the equations to impose, while those of `BCTypeCompound_t` give a general description of the class of boundary-condition equations to impose. The specific boundary-condition equations to enforce for each value of `BCType_t` are listed in [Table 7](#) and [Table 8](#).

The subdivision of `BCType_t` is based on function. For simple boundary conditions, the equations and data imposed are fixed; whereas, for compound boundary conditions different sets of equations are imposed depending on local flow conditions at the boundary. This distinction requires additional rules for dealing with simple and compound boundary-condition types. These rules are discussed in [Section 9.8](#).

For the inflow/outflow boundary-condition descriptions, 3-D inviscid compressible flow is assumed; the 2-D equivalent should be obvious. These same boundary conditions are typically used for viscous cases also. This “3-D Euler” assumption will be noted wherever used.

In the following tables, Q is the solution vector, \vec{q} is the velocity vector whose magnitude is q , the unit normal to the boundary is \hat{n} , and $\partial()/\partial n = \hat{n} \cdot \nabla$ is differentiation normal to the boundary.

Table 7: Simple Boundary Condition Types

BCType_t or BCTypeSimple_t Identifier	Boundary Condition Description
BCGeneral	Arbitrary conditions on Q or $\partial Q/\partial n$
BCDirichlet	Dirichlet condition on Q vector
BCNeumann	Neumann condition on $\partial Q/\partial n$
BCExtrapolate	Extrapolate Q from interior
BCWallInviscid	Inviscid (slip) wall <ul style="list-style-type: none"> • normal velocity specified (default: $\vec{q} \cdot \hat{n} = 0$)
BCWallViscousHeatFlux	Viscous no-slip wall with heat flux <ul style="list-style-type: none"> • velocity Dirichlet (default: $q = 0$) • temperature Neumann (default: adiabatic, $\partial T/\partial n = 0$)
BCWallViscousIsothermal	Viscous no-slip, isothermal wall <ul style="list-style-type: none"> • velocity Dirichlet (default: $q = 0$) • temperature Dirichlet
BCWallViscous	Viscous no-slip wall; special cases are BCWallViscousHeatFlux and BCWallViscousIsothermal <ul style="list-style-type: none"> • velocity Dirichlet (default: $q = 0$) • Dirichlet or Neumann on temperature
BCWall	General wall condition; special cases are BCWallInviscid, BCWallViscous, BCWallViscousHeatFlux and BCWallViscousIsothermal
BCInflowSubsonic	Inflow with subsonic normal velocity <ul style="list-style-type: none"> • specify 4; extrapolate 1 (3-D Euler)
BCInflowSupersonic	Inflow with supersonic normal velocity <ul style="list-style-type: none"> • specify 5; extrapolate 0 (3-D Euler) Same as BCDirichlet
BCOutflowSubsonic	Outflow with subsonic normal velocity <ul style="list-style-type: none"> • specify 1; extrapolate 4 (3-D Euler)
BCOutflowSupersonic	Outflow with supersonic normal velocity <ul style="list-style-type: none"> • specify 0; extrapolate 5 (3-D Euler) Same as BCExtrapolate
BCTunnelInflow	Tunnel inlet (subsonic normal velocity) <ul style="list-style-type: none"> • specify cross-flow velocity, stagnation enthalpy, entropy • extrapolate 1 (3-D Euler)

Continued on next page

Table 7: Simple Boundary Condition Types (Continued)

BCType_t or BCTypeSimple_t Identifier	Boundary Condition Description
BCTunnelOutflow	Tunnel exit (subsonic normal velocity) <ul style="list-style-type: none"> • specify static pressure • extrapolate 4 (3-D Euler)
BCDegenerateLine	Face degenerated to a line 
BCDegeneratePoint	Face degenerated to a point 
BCSymmetryPlane	Symmetry plane; face should be coplanar <ul style="list-style-type: none"> • density, pressure: $\partial()/\partial n = 0$ • tangential velocity: $\partial(\vec{q} \times \hat{n})/\partial n = 0$ • normal velocity: $\vec{q} \cdot \hat{n} = 0$
BCSymmetryPolar	Polar-coordinate singularity line; special case of BCDegenerateLine where degenerate face is a straight line and flowfield has polar symmetry; \hat{s} is singularity line tangential unit vector <ul style="list-style-type: none"> • normal velocity: $\vec{q} \times \hat{s} = 0$ • all others: $\partial()/\partial n = 0$, n normal to \hat{s}
BCAxisymmetricWedge	Axisymmetric wedge; special case of BCDegenerateLine where degenerate face is a straight line
FamilySpecified	A boundary condition type is being specified for the family to which the current boundary belongs. A <code>FamilyName_t</code> specification must exist under <code>BC_t</code> , corresponding to a <code>Family_t</code> structure under <code>CGNSBase_t</code> . Under the <code>Family_t</code> structure there must be a <code>FamilyBC_t</code> structure specifying a valid <code>BCType</code> (other than <code>FamilySpecified!</code>). If any of these are absent, the boundary condition type is undefined.

Table 8: Compound Boundary Condition Types

<code>BCType_t</code> or <code>BCTypeCompound_t</code> Identifier	Boundary Condition Description
<code>BCInflow</code>	Inflow, arbitrary normal Mach; test on normal Mach, then perform one of: <code>BCInflowSubsonic</code> , <code>BCInflowSupersonic</code>
<code>BCOutflow</code>	Outflow, arbitrary normal Mach; test on normal Mach, then perform one of: <code>BCOutflowSubsonic</code> , <code>BCOutflowSupersonic</code>
<code>BCFarfield</code>	Farfield inflow/outflow, arbitrary normal Mach; test on normal velocity and normal Mach, then perform one of: <code>BCInflowSubsonic</code> , <code>BCInflowSupersonic</code> , <code>BCOutflowSubsonic</code> , <code>BCOutflowSupersonic</code>

9.8 Matching Boundary Condition Data Sets

The `BC_t` structure allows for an arbitrary list of boundary-condition data sets, described by the `BCDataSet_t` structure. For simple boundary conditions, a single data set must be chosen from a list that may contain more than one element. Likewise, for a compound boundary condition, a limited number of data sets must be chosen and applied appropriately. The mechanism for the proper choice of data sets is controlled by the `BCType` field of the `BC_t` structure, the `BCTypeSimple` field of the `BCDataSet_t` structure, and the boundary-condition type association table (Table 9). In the following discussion, we will use the “/” notation for fields or elements of a structure type.

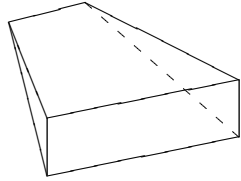
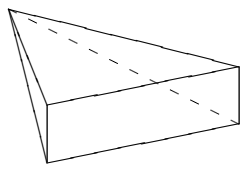
`BC_t` is used for both simple and compound boundary conditions; hence, the field `BC_t/BCType` is of type `BCType_t`. Conversely, the substructure `BCDataSet_t` is intended to enforce a single set of boundary-condition equations independent of local flow conditions (i.e., it is appropriate only for simple boundary conditions). This is why the field `BCDataSet_t/BCTypeSimple` is of type `BCTypeSimple_t` and not `BCType_t`. The appropriate choice of data sets is determined by matching the field `BC_t/BCType` with the field `BCDataSet_t/BCTypeSimple` as specified in Table 9.

For simple boundary conditions, a single match from the list of `BCDataSet_t` instances is required. For all `BCTypeSimple_t` identifiers, except `BCInflowSupersonic` and `BCOutflowSupersonic`, an exact match is necessary. `BCInflowSupersonic` will match itself or `BCDirichlet`; `BCOutflowSupersonic` will match itself or `BCExtrapolate`.

For compound boundary conditions, the association table specifies which simple boundary-condition types are appropriate. Since compound boundary conditions enforce different boundary-condition equation sets depending on local flow conditions, several instances of `BCDataSet_t` will be matched for each `BCTypeCompound_t` identifier. The accompanying rule determines which of the matching data sets to apply at a given location on the BC patch.

This provides a general procedure applicable to both `BCTypeSimple_t` and `BCTypeCompound_t` situations. For a given `BC_t/BCType` use those instances of `BCDataSet_t` whose field `BCDataSet_t/BCTypeSimple` matches according to Table 9. Apply the matching data set or sets as prescribed by the appropriate usage rule.

Table 9: Associated Boundary Condition Types and Usage Rules

BCType_t Identifier	Associated BCTypeSimple_t Identifiers and Usage Rules
BCInflow	BCInflowSupersonic BCInflowSubsonic <i>Usage Rule:</i> <ul style="list-style-type: none"> • if supersonic normal Mach, choose BCInflowSupersonic; • else, choose BCInflowSubsonic
BCOutflow	BCOutflowSupersonic BCOutflowSubsonic <i>Usage Rule:</i> <ul style="list-style-type: none"> • if supersonic normal Mach, choose BCOutflowSupersonic; • else, choose BCOutflowSubsonic
BCFarfield	BCInflowSupersonic BCInflowSubsonic BCOutflowSupersonic BCOutflowSubsonic <i>Usage Rule:</i> <ul style="list-style-type: none"> • if inflow and supersonic normal Mach, choose BCInflowSupersonic; • else if inflow, choose BCInflowSubsonic; • else if outflow and supersonic normal Mach, choose BCOutflowSupersonic; • else, choose BCOutflowSubsonic
BCInflowSupersonic	BCInflowSupersonic BCDirichlet <i>Usage Rule:</i> <ul style="list-style-type: none"> • choose either; BCInflowSupersonic takes precedence
BCOutflowSupersonic	BCOutflowSupersonic BCExtrapolate <i>Usage Rule:</i> <ul style="list-style-type: none"> • choose either; BCOutflowSupersonic takes precedence
All others	Self-matching

Although we present a strict division between the two categories of boundary-condition types, we realize that some overlap may exist. For example, some of the more general simple boundary-condition types, such as BCWall, may include a situation of inflow/outflow (say if the wall is porous). These complications require further guidelines on appropriate definition and use of boundary-condition types. The real distinctions between BCTypeSimple_t and BCTypeCompound_t are as follows:

- `BTypeSimple_t` identifiers always match themselves; `BTypeCompound_t` identifiers never match themselves.
- `BTypeSimple_t` identifiers always produce a single match; `BTypeCompound_t` will produce multiple matches.
- The usage rule for `BTypeSimple_t` identifiers is always trivial—apply the single matching data set regardless of local flow conditions.

Therefore, any boundary condition that involves application of different data sets depending on local flow conditions should be classified `BTypeCompound_t`. If a type that we have classified `BTypeSimple_t` is used as a compound type (`BCWall` for a porous wall is an example), then it should somehow be reclassified. One option is to define a new `BTypeCompound_t` identifier and provide associated `BTypeSimple_t` types and a usage rule. Another option may be to allow some identifiers to be both `BTypeSimple_t` and `BTypeCompound_t` and let their appropriate use be based on context. This is still undetermined.

9.9 Boundary Condition Specification Data

For a given simple boundary condition (i.e., one that is not dependent on local flow conditions), the database provides a set of boundary-condition equations to be enforced through the structure definitions for `BCDataSet_t` and `BCData_t` (Section 9.4 and Section 9.5). Apart from the boundary-condition type, the precise equations to be enforced are described by boundary-condition solution data. These specified solution data are arranged by “equation type”:

Dirichlet: $Q = (Q)_{\text{specified}}$

Neumann: $\partial Q / \partial n = (\partial Q / \partial n)_{\text{specified}}$

The `DirichletData` and `NeumannData` entities of `BCData_t` list both the solution variables involved in the equations (through the data-name identifier conventions of Appendix A) and the specified solution data.

Two issues need to be addressed for specifying Dirichlet or Neumann boundary-condition data. The first is whether the data is global or local:

Global BC data: Data applied globally to the BC patch; for example, specifying a uniform total pressure at an inflow boundary

Local BC data: Data applied locally at each vertex or cell face of the BC patch; an example of this is varying total pressure specified at each grid point at an inflow boundary

The second issue is describing the actual solution quantities that are to be specified. Both of these issues are addressed by use of the `DataArray_t` structure.

For some types of boundary conditions, many different combinations of solution quantities could be specified. For example, `BCInflowSubsonic` requires 4 solution quantities to be specified in 3-D, but what those 4 quantities are varies with applications (e.g., internal verses external flows) and codes. We propose the convention that the actual data being specified for any `BCType` is given by the list of `DataArray_t` entities included in `DirichletData` and `NeumannData` structures (actually by the identifier attached to each instance of `DataArray_t`). This frees us from having to define *many* versions of a given `BCType` (e.g., `BCInflowSubsonic1`, `BCInflowSubsonic2`, etc.), where each has a precisely defined set of Dirichlet data. We are left with the easier task of defining *how many* Dirichlet or Neumann quantities must be provided for each `BCType`.

An example of using `DataArray_t`-identifier conventions to describe BC specification data is the following: subsonic inflow with uniform stagnation pressure, mass flow and cross-flow angle specified; the Dirichlet data are stagnation pressure = 2.56, mass flow = 1.34, and cross-flow angle has a y -component of 0.043 and a z -component of 0.02 (ignore dimensional-units or normalization for the present). The specified solution variables and associated data are described as shown:

```
BCData_t<ListLength=?> DirichletData =
  {{
    DataArray_t<real, 1, 1> PressureStagnation = {{ Data(real, 1, 1) = 2.56 }} ;
    DataArray_t<real, 1, 1> MassFlow          = {{ Data(real, 1, 1) = 1.34 }} ;
    DataArray_t<real, 1, 1> VelocityAngleY   = {{ Data(real, 1, 1) = 0.043 }} ;
    DataArray_t<real, 1, 1> VelocityAngleZ   = {{ Data(real, 1, 1) = 0.02 }} ;
  }} ;
```

Basically, this states that `DirichletData` contains four instances of `DataArray_t` with identifiers or names `PressureStagnation`, `MassFlow`, `VelocityAngleY` and `VelocityAngleZ`. Each `DataArray_t` structure entity contains a single floating-point value; these are the Dirichlet data for the BC. Note that `Data(real, 1, 1)` means a single floating-point value.

The global verses local data issue can be easily handled by storing either a scalar, as shown above, for the global BC data case; or storing an array for the local BC data case. Storing an array of local BC data allows the capability for specifying non-constant solution profiles, such as “analytic” boundary-layer profiles or profiles derived from experimental data. For the above example, if the stagnation pressure is instead specified at every vertex of the boundary-condition patch the following results:

```
BCData_t<ListLength=99> DirichletData =
  {{
    DataArray_t<real, 1, 99> PressureStagnation =
      {{ Data(real, 1, 99) = (PTOT(n), n=1,99) }} ;
    DataArray_t<real, 1, 1> MassFlow          = {{ Data(real, 1, 1) = 1.34 }} ;
    DataArray_t<real, 1, 1> VelocityAngleY   = {{ Data(real, 1, 1) = 0.043 }} ;
    DataArray_t<real, 1, 1> VelocityAngleZ   = {{ Data(real, 1, 1) = 0.02 }} ;
  }} ;
```

where, say, the boundary face is logically rectangular and contains 11×9 vertices and the stagnation pressure at the vertices is given by the array `PTOT()`.

To facilitate implementation of boundary conditions into existing flow solvers, we adopt the convention that if no boundary-condition data is specified, then flow solvers are free to enforce any appropriate boundary-condition equations. This includes situations where entities of `BCDataSet_t`, `BCData_t` or `DataArray_t` are absent within the boundary-condition hierarchy. By convention, if no `BCDataSet` entities are present, then application codes are free to enforce appropriate BCs for the given value of `BCType`. Furthermore, if the entities `DirichletData` and `NeumannData` are not present in an instance of `BCDataSet_t`, or if insufficient data is present in `DirichletData` or `NeumannData` (e.g., if only one Dirichlet variable is present for a subsonic inflow condition), then application codes are free to fill out the boundary-condition data as appropriate for the `BCTypeSimple` identifier.

The various levels of BC implementation allowed are shown in Figure 10, from the lowest level in which the application codes interpret the `BCType`, to the fully SIDS-compliant BC implementation that completely defines the BC within the CGNS file.

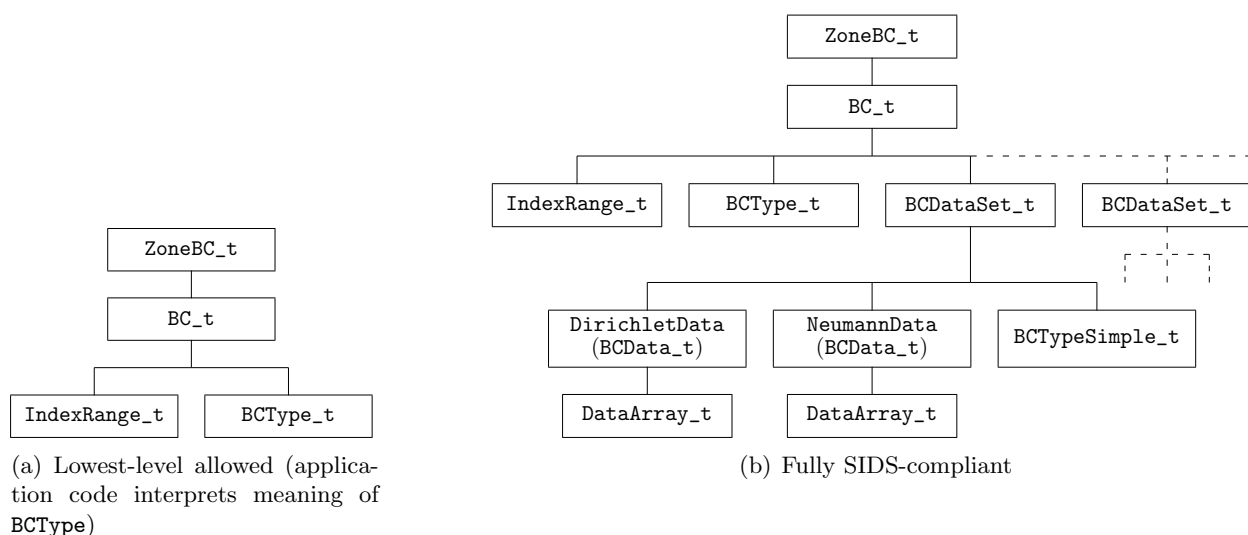

Figure 10: Boundary Condition Implementation Levels

An alternative approach to the present design could be to list all the solution variables and data (as `DataArray_t`-like structures) for the boundary condition, and contain descriptive tags in each one to indicate if they are Dirichlet or Neumann data. We have not taken this approach. We think grouping boundary-condition data by “equation type” as we have done better allows for future extension to other types of boundary conditions (e.g., 2nd-order non-reflecting BC’s that result in partial differential equations to be solved at the boundary).

9.10 Boundary Condition Examples

This section contains boundary-condition examples with increasing complexity. Included is the most simple `BC_t` entity and one of the most complex. The examples show situations of local and global boundary-condition data, simple and compound boundary-condition types, and multiple boundary-condition data sets that must be matched with the appropriate boundary-condition type.

Example 9-A: Symmetry Plane

Symmetry plane for a patch on the i -min face of a 3-D structured zone.

```
! CellDimension = 3, IndexDimension = 3
BC_t<3,3,3> BC1 =
  {{
    BCType_t BCType = BCSymmetryPlane ;

    IndexRange_t<3> PointRange =
      {{
        int[3] Begin = [1,1,1 ] ;
        int[3] End   = [1,9,17] ;
      }} ;
  }} ;
```

Since the boundary-condition equations to be enforced are completely defined by the boundary-condition type `BCSymmetryPlane`, no other information needs to be provided, except for the extent of the BC patch. The BC patch is specified by `PointRange` with a beginning index of (1,1,1) and an ending index of (1,9,17). By default, these refer to vertices.

Example 9-B: Viscous Solid Wall I

A viscous solid wall for a 3-D structured zone, where a Dirichlet condition is enforced for temperature; the wall temperature for the entire wall is specified to be 273 K. The BC patch is on the j -min face and is bounded by the indices (1,1,1) and (33,1,9).

```
! CellDimension = 3, IndexDimension = 3
BC_t<3,3,3> BC2 =
  {{
    BCType_t BCType = BCWallViscousIsothermal ;

    IndexRange_t<3> PointRange =
      {{
        int[3] Begin = [1 ,1,1] ;
        int[3] End   = [33,1,9] ;
      }} ;

    ! ListLength = 33*9 = 297
    BCDataSet_t<297> BCDataSet1 =
      {{
        BCTypeSimple_t BCTypeSimple = BCWallViscousIsothermal ;

        ! Data array length = ListLength = 297
        BCData_t<297> DirichletData =
          {{
            DataArray_t<real, 1, 1> Temperature =
```

```
    {{
    Data(real, 1, 1) = 273. ;

    DataClass_t DataClass = Dimensional ;

    DimensionalUnits_t DimensionalUnits =
    {{
    MassUnits          = MassUnitsNull ;
    LengthUnits       = LengthUnitsNull ;
    TimeUnits         = TimeUnitsNull ;
    TemperatureUnits = Kelvin ;
    AngleUnits        = AngleUnitsNull ;
    }} ;
    }} ;
}} ;
}} ;
```

This is an example of a simple boundary-condition type, `BCWallViscousIsothermal`. By default there is a zero Dirichlet condition on the velocity, and `BCDataSet1` states there is a Dirichlet condition on temperature with a global value of 273 K. The data set contains a single `BCData_t` entity, called `DirichletData`, meaning a (possibly empty) collection of Dirichlet conditions should be enforced. Within `DirichletData`, there is a single `DataArray_t` entity; this narrows the specification to a single Dirichlet condition. This lone entity has the identifier `Temperature`, which by conventions defined in [Appendix A](#) is the identifier for static temperature. The data contained in `Temperature` is a floating-point scalar with a value of 273. The qualifiers `DataClass` and `DimensionalUnits` specify that the temperature is dimensional with units of Kelvin.

Since `BCWallViscousIsothermal` is a simple boundary-condition type, the appropriate data set contains a `BCTypeSimple` entity whose value is `BCWallViscousIsothermal`. For this example, only a single data set is provided, and this data set has the correct boundary-condition type. This is an example of a trivial data-set match.

Apart from velocity and temperature, additional “numerical” boundary conditions are typically required by Navier-Stokes flow solvers, but none are given here; therefore, a code is free to implement other additional boundary conditions as desired.

Although the boundary-condition data is global, we include in this example structure parameters that are the lengths of potential local-data arrays. Comments are added to the example with the “!” notation to document the structure parameters. The `BC_t` structure function `ListLength` is evaluated based on `PointRange`. Since `GridLocation` is not specified in `BC2`, any local data is at vertices by default. The entity `Temperature` contains global data, so the value of `ListLength` is unused in `DirichletData`.

This example raises the question of whether unused structure parameters are required in structure entities. The answer is no. We included them here for completeness. The purpose of structure parameters is to mimic the need to define elements of an entity based on information contained elsewhere (at a higher level) in the CGNS database. When this need is not present in a given

instance of a structure entity, the structure parameters are superfluous. In some of the following examples, structure parameters that are superfluous or otherwise not needed are denoted by “?”.

Example 9-C: Subsonic Inflow

Subsonic inflow for a 2-D structured zone: The BC patch is on the i -min face and includes $j \in [2, 7]$. As prescribed by the boundary-condition type, three quantities must be specified. Uniform entropy and stagnation enthalpy are specified with values of 0.94 and 2.85, respectively. A velocity profile is specified at face midpoints, given by the array `v_inflow(j)`. No dimensional or nondimensional information is provided.

```
! CellDimension = 2, IndexDimension = 2
BC_t<2,2,?> BC3 =
  {{
    BCType_t BCType = BCInflowSubsonic ;

    GridLocation_t GridLocation = FaceCenter ;

    IndexRange_t<2> PointRange =
      {{
        int[2] Begin = [1,2] ;
        int[2] End   = [1,6] ;
      }} ;

! ListLength = 5
BCDataSet_t<5> BCDataSet1 =
  {{
    BCTypeSimple_t BCTypeSimple = BCInflowSubsonic ;

! Data array length = ListLength = 5
BCData_t<5> DirichletData =
  {{
    DataArray_t<real, 1, 1> EntropyApprox =
      {{
        Data(real, 1, 1) = 0.94 ;
      }} ;

    DataArray_t<real, 1, 1> EnthalpyStagnation =
      {{
        Data(real, 1, 1) = 2.85 ;
      }} ;

    DataArray_t<real, 1, 5> VelocityY =
      {{
        Data(real, 1, 5) = (v_inflow(j), j=3,7) ;
      }} ;
```

```
    }} ;  
  }} ;  
}} ;
```

This is another example of a simple boundary-condition type. The primary additional complexity included in this example is multiple Dirichlet conditions with one containing local data. `DirichletData` contains three `DataArray_t` entities named `EntropyApprox`, `EnthalpyStagnation` and `VelocityY`. This specifies three Dirichlet boundary conditions to be enforced, and the names identify the solution quantities to set. Since both `EntropyApprox` and `EnthalpyStagnation` have an array-length structure parameter of one, they identify global data, and the values are provided. `VelocityY` is an array of data values and contains the values in `v_inflow()`. The length of the array is given by `ListLength`, which represents the number of cell faces because `BC3` is specified using the value of `FaceCenter` for `GridLocation`. Note that the beginning and ending indices on the array `v_inflow()` are unimportant (they are user inputs); there just needs to be five values provided.

Example 9-D: Outflow

Outflow boundary condition with unspecified normal Mach number for an *i*-max face of a 3-D structured zone: for subsonic outflow, a uniform pressure is specified; for supersonic outflow, no boundary-condition equations are specified.

```
! CellDimension = 3, IndexDimension = 3  
BC_t<3,3,3> BC4 =  
  {{  
    BCType_t BCType = BCOutflow ;  
  
    IndexRange_t<3> PointRange = {{ }} ;  
  
    BCDataSet_t<?> BCDataSetSubsonic =  
      {{  
        BCTypeSimple_t BCTypeSimple = BCOutflowSubsonic ;  
  
        BCData_t<?> DirichletData =  
          {{  
            DataArray_t<real, 1, 1> Pressure = {{ }} ;  
          }} ;  
        }} ;  
  
    BCDataSet_t<?> BCDataSetSupersonic =  
      {{  
        BCTypeSimple_t BCTypeSimple = BCOutflowSupersonic ;  
      }} ;  
    }} ;
```

This is an example of a complex boundary-condition type; the equation set to be enforced depends on the local flow conditions, namely the Mach number normal to the boundary. Two data sets

are provided, `BCDataSetSubsonic` and `BCDataSetSupersonic`; recall the names are unimportant and are user defined. The first data set has a boundary-condition type of `BCOutflowSubsonic` and prescribes a global Dirichlet condition on static pressure. Any additional boundary conditions needed may be applied by a flow solver. The second data set has a boundary-condition type of `BCOutflowSupersonic` with no additional boundary-condition equation specification. Typically, all solution quantities are extrapolated from the interior for supersonic outflow. From the boundary-condition type association table (Table 9), `BCOutflow` requires two data sets with boundary-condition types `BCOutflowSubsonic` and `BCOutflowSupersonic`. The accompanying usage rule states that the data set for `BCOutflowSubsonic` should be used for a subsonic normal Mach number; otherwise, the data set for `BCOutflowSupersonic` should be enforced.

Any additional data sets with boundary-condition types other than `BCOutflowSubsonic` or `BCOutflowSupersonic` could be provided (the definition of `BC_t` allows an arbitrary list of `BCDataSet_t` entities); however, they should be ignored by any code processing the boundary-condition information. Another caveat is that providing two data sets with the same simple boundary-condition type would cause indeterminate results — which one is the correct data set to apply?

The actual global data value for static pressure is not provided; an abbreviated form of the `Pressure` entity is shown. This example also uses the “?” notation for unused data-array-length structure parameters.

Example 9-E: Farfield

Farfield boundary condition with arbitrary flow conditions for a j -max face of a 2-D structured zone: If subsonic inflow, specify entropy, vorticity and incoming acoustic characteristics; if supersonic inflow specify entire flow state; if subsonic outflow, specify incoming acoustic characteristic; and if supersonic outflow, extrapolate all flow quantities. None of the extrapolated quantities for the different boundary condition possibilities need be stated.

```
! CellDimension = 2, IndexDimension = 2
BC_t<2,2,2> BC5 =
  {{
    BCType_t BCType = BCFarfield ;

    IndexRange_t<2> PointRange = {{ }} ;

    int[2] InwardNormalIndex = [0,-1] ;

    BCDataSet_t<?> BCDataSetInflowSupersonic =
      {{
        BCTypeSimple_t BCTypeSimple = BCInflowSupersonic ;
      }} ;

    BCDataSet_t<?> BCDataSetInflowSubsonic =
      {{
        BCTypeSimple_t BCTypeSimple = BCInflowSubsonic ;
```

```
BCData<?> DirichletData =
  {{
    DataArray_t<real, 1, 1> CharacteristicEntropy      = {{ }} ;
    DataArray_t<real, 1, 1> CharacteristicVorticity1   = {{ }} ;
    DataArray_t<real, 1, 1> CharacteristicAcousticPlus = {{ }} ;
  }} ;

BCDataSet_t<?> BCDataSetOutflowSupersonic =
  {{
    BCTypeSimple_t BCTypeSimple = BCOutflowSupersonic ;
  }} ;

BCDataSet_t<?> BCDataSetOutflowSubsonic =
  {{
    BCTypeSimple_t BCTypeSimple = BCOutflowSubsonic ;

    BCData<?> DirichletData =
      {{
        DataArray_t<real, 1, 1> CharacteristicAcousticMinus = {{ }} ;
      }} ;
  }} ;
```

The farfield boundary-condition type is the most complex of the compound boundary-condition types. `BCFarfield` requires four data sets; these data sets must contain the simple boundary-condition types `BCInflowSupersonic`, `BCInflowSubsonic`, `BCOutflowSupersonic` and `BCOutflowSubsonic`. This example provides four appropriate data sets. The usage rule given for `BCFarfield` in [Table 9](#) states which set of boundary-condition equations to be enforced based on the normal velocity and normal Mach number.

The data set for supersonic-inflow provides no information other than the boundary-condition type. A flow solver is free to apply any conditions that are appropriate; typically all solution quantities are set to freestream reference state values. The data set for subsonic-inflow states that three Dirichlet conditions should be enforced; the three data identifiers provided are among the list of conventions given in [Appendix A.5](#). The data set for supersonic-outflow only provides the boundary-condition type, and the data set for subsonic-outflow provides one Dirichlet condition on the incoming acoustic characteristic, `CharacteristicAcousticMinus`.

Also provided in the example is the inward-pointing computational-coordinate normal; the normal points in the $-j$ direction, meaning the BC patch is a j -max face. This information could also be obtained from the BC patch description given in [IndexRange](#).

Note that this example shows only the overall layout of the boundary-condition entity. `IndexRange` and all `DataArray_t` entities are abbreviated, and all unused structure functions are not evaluated.

Example 9-F: Viscous Solid Wall II

There are circumstances when a user may wish to define a BC patch using vertices (under `BC_t`), but store the BC data at face centers (under `BCDataSet_t`). The following example is similar to [Example 9-B](#), with the exception that the Dirichlet data for temperature is stored at face centers rather than at vertices.

As before, the example is a viscous solid wall in a 3-D structured zone, where a Dirichlet condition is enforced for temperature; the wall temperature for the entire wall is specified to be 273 K. The BC patch is on the j -min face and is bounded by the indices (1,1,1) and (33,1,9).

```
! CellDimension = 3, IndexDimension = 3
BC_t<3,3,3> BC2 =
  {{
  BCType_t BCType = BCWallViscousIsothermal ;

! Grid location is Vertex by default
IndexRange_t<3> PointRange =
  {{
  int[3] Begin = [1 ,1,1] ;
  int[3] End   = [33,1,9] ;
  }} ;

! ListLength = 33*9 = 297
BCDataSet_t<297> BCDataSet1 =
  {{
  BCTypeSimple_t BCTypeSimple = BCWallViscousIsothermal ;

GridLocation_t GridLocation = FaceCenter ;
IndexRange_t<3> PointRange =

  int[3] Begin = [1 ,1,1] ;
  int[3] End   = [32,1,8] ;
  ;

! ListLength = 32*8 = 256
BCData_t<256> DirichletData =
  {{
  DataArray_t<real, 1, 1> Temperature =
    {{
    Data(real, 1, 1) = 273. ;

  DataClass_t DataClass = Dimensional ;

  DimensionalUnits_t DimensionalUnits =
    {{
```

```
    MassUnits      = MassUnitsNull ;
    LengthUnits    = LengthUnitsNull ;
    TimeUnits      = TimeUnitsNull ;
    TemperatureUnits = Kelvin ;
    AngleUnits     = AngleUnitsNull ;
  }} ;
}} ;
}} ;
}} ;
```

As in [Example 9-B](#), although the boundary-condition data is global, we include in this example structure parameters that are the lengths of potential local-data arrays. In `BC_t`, `GridLocation` is not specified, and thus is `Vertex` by default. The structure function `ListLength` is 297, based on the specification of `PointRange`, and that value is passed to `BCDataSet_t`.

In this example `PointRange` is specified in `BCDataSet_t`, so the `ListLength` passed into it from `BC_t` is not used. In `BCDataSet_t`, `GridLocation` is specified as `FaceCenter`, and `PointRange` is set accordingly. The corresponding value of `ListLength` is 256, which is passed into `BCData_t`.

As before, in `BCData_t` the entity `Temperature` contains global data, so the value of `ListLength` is unused.

10 Governing Flow Equations

This section provides structure type definitions for describing the governing flow-equation set associated with the database. The description includes the general class of governing equations, the turbulent closure equations, the gas and chemistry models, the viscosity and thermal-conductivity models, and the electromagnetics models. Included with each equation description are associated constants. The structure definitions attempt to balance the opposing requirements for future growth and extensibility with initial ease of implementation. Included in the final section ([Section 10.11](#)) are examples of flow-equation sets.

The intended use of these structures initially is primarily for archival purposes and to provide additional documentation of the flow solution. If successful in this role, it is foreseeable that these flow-equation structures may eventually be also used as inputs for grid generators, flow solvers, and post-processors.

10.1 Flow Equation Set Structure Definition: FlowEquationSet_t

FlowEquationSet_t is a general description of the governing flow equations. It includes the dimensionality of the governing equations, and the collection of specific equation-set descriptions covered in subsequent sections. It can be a child node of either CGNSBase_t or Zone_t (or both).

```
FlowEquationSet_t< int CellDimension > :=  
  {  
    List( Descriptor_t Descriptor1 ... DescriptorN ) ;           (o)  
  
    int EquationDimension ;                                     (o)  
  
    GoverningEquations_t<CellDimension> GoverningEquations ;   (o)  
  
    GasModel_t GasModel ;                                       (o)  
  
    ViscosityModel_t ViscosityModel ;                           (o)  
  
    ThermalConductivityModel_t ThermalConductivityModel ;     (o)  
  
    TurbulenceClosure_t TurbulenceClosure ;                   (o)  
  
    TurbulenceModel_t<CellDimension> TurbulenceModel ;        (o)  
  
    ThermalRelaxationModel_t ThermalRelaxationModel ;         (o)  
  
    ChemicalKineticsModel_t ChemicalKineticsModel ;          (o)  
  
    EMElectricFieldModel_t EMElectricFieldModel ;            (o)
```

```
EMMagneticFieldModel_t EMMagneticFieldModel ; (o)

EMConductivityModel_t EMConductivityModel ; (o)

DataClass_t DataClass ; (o)

DimensionalUnits_t DimensionalUnits ; (o)

List( UserDefinedData_t UserDefinedData1 ... UserDefinedDataN ) ; (o)
} ;
```

Notes

1. Default names for the `Descriptor_t` and `UserDefinedData_t` lists are as shown; users may choose other legitimate names. Legitimate names must be unique within a given instance of `FlowEquationSet_t` and shall not include the names `EMConductivityModel`, `EMElectricFieldModel`, `EMMagneticFieldModel`, `EquationDimension`, `GoverningEquations`, `GasModel`, `ViscosityModel`, `ThermalConductivityModel`, `TurbulenceClosure`, `TurbulenceModel`, `ThermalRelaxationModel`, `ChemicalKineticsModel`, `DataClass`, or `DimensionalUnits`.
2. There are no required elements for `FlowEquationSet_t`.

`FlowEquationSet_t` requires a single structure parameter, `CellDimension`, to identify the dimensionality of index arrays for structured grids. This parameter is passed onto several substructures.

`EquationDimension` is the dimensionality of the governing equations; it is the number of spatial variables describing the flow. `GoverningEquations` describes the general class of flow equations. `GasModel` describes the equation of state, and `ViscosityModel` and `ThermalConductivityModel` describe the auxiliary relations for molecular viscosity and the thermal conductivity coefficient. `TurbulenceClosure` and `TurbulenceModel` describe the turbulent closure for the Reynolds-averaged Navier-Stokes equations. `ThermalRelaxationModel` and `ChemicalKineticsModel` describe the equations used to model thermal relaxation and chemical kinetics. `EMElectricFieldModel`, `EMMagneticFieldModel`, and `EMConductivityModel` describe the equations used to model electromagnetics.

`DataClass` defines the default for the class of data contained in the flow-equation set. For any data that is dimensional, `DimensionalUnits` may be used to describe the system of dimensional units employed. If present, these two entities take precedence over all corresponding entities at higher levels of the hierarchy. These precedence rules are further discussed in [Section 6.4](#).

The `UserDefinedData_t` data structure allows arbitrary user-defined data to be stored in `Descriptor_t` and `DataArray_t` children without the restrictions or implicit meanings imposed on these node types at other node locations.

10.2 Governing Equations Structure Definition: `GoverningEquations_t`

`GoverningEquations_t` describes the class of governing flow equations associated with the solution.

```

GoverningEquationsType_t := Enumeration(
  GoverningEquationsTypeNull,
  GoverningEquationsTypeUserDefined,
  FullPotential,
  Euler,
  NSLaminar,
  NSTurbulent,
  NSLaminarIncompressible,
  NSTurbulentIncompressible ) ;

GoverningEquations_t< int CellDimension > :=
{
  List( Descriptor_t Descriptor1 ... DescriptorN ) ;           (o)

  GoverningEquationsType_t GoverningEquationsType ;         (r)

  int[CellDimension*(CellDimension + 1)/2] DiffusionModel ;  (o)

  List( UserDefinedData_t UserDefinedData1 ... UserDefinedDataN ) ; (o)
} ;

```

Notes

1. Default names for the `Descriptor_t` and `UserDefinedData_t` lists are as shown; users may choose other legitimate names. Legitimate names must be unique within a given instance of `GoverningEquations_t` and shall not include the name `DiffusionModel`.
2. `GoverningEquationsType` is the only required element.
3. The length of the `DiffusionModel` array is as follows: in 1-D it is `int[1]`; in 2-D it is `int[3]`; and in 3-D it is `int[6]`. For unstructured zones, `DiffusionModel` is not supported, and should not be used.

`GoverningEquations_t` requires a single structure parameter, `CellDimension`. It is used to define the length of the array `DiffusionModel`.

`DiffusionModel` describes the viscous diffusion terms modeled in the flow equations, and is applicable only to the Navier-Stokes equations with structured grids. Typically, thin-layer approximations include only the diffusion terms in one or two computational-coordinate directions. `DiffusionModel` encodes the coordinate directions that include second-derivative and cross-derivative diffusion terms. The first `CellDimension` elements are second-derivative terms and the remainder elements are cross-derivative terms. Allowed values for individual elements in the array `DiffusionModel` are 0 and 1; a value of 1 indicates the diffusion term is modeled, and 0 indicates that they are not modeled. In 3-D, the encoding of `DiffusionModel` is as follows:

Element	Modeled Terms
$n = 1$	Diffusion terms in i ($\partial^2/\partial\xi^2$)
$n = 2$	Diffusion terms in j ($\partial^2/\partial\eta^2$)
$n = 3$	Diffusion terms in k ($\partial^2/\partial\zeta^2$)
$n = 4$	Cross-diffusion terms in i - j ($\partial^2/\partial\xi\partial\eta$ and $\partial^2/\partial\eta\partial\xi$)
$n = 5$	Cross-diffusion terms in j - k ($\partial^2/\partial\eta\partial\zeta$ and $\partial^2/\partial\zeta\partial\eta$)
$n = 6$	Cross-diffusion terms in k - i ($\partial^2/\partial\zeta\partial\xi$ and $\partial^2/\partial\xi\partial\zeta$)

where derivatives in the i , j and k computational-coordinates are ξ , η and ζ , respectively. The full Navier-Stokes equations in 3-D are indicated by `DiffusionModel = [1,1,1,1,1,1]`, and the thin-layer equations including only diffusion in the j -direction are `[0,1,0,0,0,0]`.

The `UserDefinedData_t` data structure allows arbitrary user-defined data to be stored in `Descriptor_t` and `DataArray_t` children without the restrictions or implicit meanings imposed on these node types at other node locations.

10.3 Model Type Structure Definition: `ModelType_t`

`ModelType_t` is a complete list of all models covered in subsequent sections. A specific model will contain a subset of this enumeration.

```
ModelType_t := Enumeration(  
  ModelTypeNull, ModelTypeUserDefined,  
  Ideal, VanderWaals, Constant, PowerLaw,  
  SutherlandLaw, ConstantPrandtl, EddyViscosity,  
  ReynoldsStress, ReynoldsStressAlgebraic,  
  Algebraic_BaldwinLomax, Algebraic_CebeciSmith,  
  HalfEquation_JohnsonKing, OneEquation_BaldwinBarth,  
  OneEquation_SpalartAllmaras, TwoEquation_JonesLaunder,  
  TwoEquation_MenterSST, TwoEquation_Wilcox,  
  CaloricallyPerfect, ThermallyPerfect, ConstantDensity,  
  RedlichKwong, Frozen, ThermalEquilib, ThermalNonequilib,  
  ChemicalEquilibCurveFit, ChemicalEquilibMinimization,  
  ChemicalNonequilib, EMElectricField, EMMagneticField,  
  EMConductivity, Voltage, Interpolated,  
  Equilibrium_LinRessler, Chemistry_LinRessler ) ;
```

10.4 Thermodynamic Gas Model Structure Definition: `GasModel_t`

`GasModel_t` describes the equation of state model used in the governing equations to relate pressure, temperature and density. The enumerated values for `GasModelType_t` are a subset of the `ModelType_t` enumeration.

```
GasModelType_t := Enumeration(  

```



```

ModelTypeNull,
ModelTypeUserDefined,
Ideal,
VanderWaals,
CaloricallyPerfect,
ThermallyPerfect,
ConstantDensity,
RedlichKwong ) ;

GasModel_t :=
{
List( Descriptor_t Descriptor1 ... DescriptorN ) ;           (o)

GasModelType_t GasModelType ;                               (r)

List( DataArray_t<DataType, 1, 1> DataArray1 ... DataArrayN ) ; (o)

DataClass_t DataClass ;                                     (o)

DimensionalUnits_t DimensionalUnits ;                       (o)

List( UserDefinedData_t UserDefinedData1 ... UserDefinedDataN ) ; (o)
} ;

```

Notes

1. Default names for the `Descriptor_t`, `DataArray_t`, and `UserDefinedData_t` lists are as shown; users may choose other legitimate names. Legitimate names must be unique within a given instance of `GasModel_t` and shall not include the names `DataClass` or `DimensionalUnits`.
2. `GasModelType` is the only required element.
3. The `GasModelType` enumeration name `Ideal` implies a calorically perfect single-component gas, but the more descriptive name `CaloricallyPerfect` is generally preferred.

For a perfect gas (`GasModelType = CaloricallyPerfect`), the pressure, temperature and density are related by,

$$p = \rho RT,$$

where R is the ideal gas constant. Related quantities are the specific heat at constant pressure (c_p), specific heat at constant volume (c_v) and specific heat ratio ($\gamma = c_p/c_v$). The gas constant and specific heats are related by $R = c_p - c_v$. Data-name identifiers associated with the perfect gas law are listed in [Table 10](#).

If it is desired to specify any of these identifiers in a CGNS database, they should be defined as `DataArrays` under `GasModel_t`.

Table 10: Data-Name Identifiers for Perfect Gas

Data-Name Identifier	Description	Units
IdealGasConstant	Ideal gas constant (R)	$\mathbf{L}^2/(\mathbf{T}^2\Theta)$
SpecificHeatRatio	Ratio of specific heats ($\gamma = c_p/c_v$)	-
SpecificHeatVolume	Specific heat at constant volume (c_v)	$\mathbf{L}^2/(\mathbf{T}^2\Theta)$
SpecificHeatPressure	Specific heat at constant pressure (c_p)	$\mathbf{L}^2/(\mathbf{T}^2\Theta)$

The dimensional units are defined as follows: \mathbf{M} is mass, \mathbf{L} is length, \mathbf{T} is time and Θ is temperature. These are further described in [Appendix A](#).

`DataClass` defines the default for the class of data contained in the thermodynamic gas model. For any data that is dimensional, `DimensionalUnits` may be used to describe the system of dimensional units employed. If present, these two entities take precedence over all corresponding entities at higher levels of the hierarchy. These precedence rules are further discussed in [Section 6.4](#).

The `UserDefinedData_t` data structure allows arbitrary user-defined data to be stored in `Descriptor_t` and `DataArray_t` children without the restrictions or implicit meanings imposed on these node types at other node locations.

10.5 Molecular Viscosity Model Structure Definition: `ViscosityModel_t`

`ViscosityModel_t` describes the model for relating molecular viscosity (μ) to temperature. The enumerated values for `ViscosityModelType_t` are a subset of the `ModelType_t` enumeration.

```

ViscosityModelType_t := Enumeration(
  ModelTypeNull,
  ModelTypeUserDefined,
  Constant,
  PowerLaw,
  SutherlandLaw ) ;

ViscosityModel_t :=
{
  List( Descriptor_t Descriptor1 ... DescriptorN ) ;           (o)

  ViscosityModelType_t ViscosityModelType ;                 (r)

  List( DataArray_t<DataType, 1, 1> DataArray1 ... DataArrayN ) ; (o)

  DataClass_t DataClass ;                                    (o)

  DimensionalUnits_t DimensionalUnits ;                     (o)

```

```
List( UserDefinedData_t UserDefinedData1 ... UserDefinedDataN ) ;      (o)
} ;
```

Notes

1. Default names for the `Descriptor_t`, `DataArray_t`, and `UserDefinedData_t` lists are as shown; users may choose other legitimate names. Legitimate names must be unique within a given instance of `ViscosityModel_t` and shall not include the names `DataClass` or `DimensionalUnits`.
2. `ViscosityModelType` is the only required element.

The molecular viscosity models are as follows: `Constant` states that molecular viscosity is constant throughout the field and is equal to some reference value ($\mu = \mu_{\text{ref}}$); `PowerLaw` states that molecular viscosity follows a power-law relation,

$$\mu = \mu_{\text{ref}} \left(\frac{T}{T_{\text{ref}}} \right)^n$$

and `SutherlandLaw` is Sutherland's Law for molecular viscosity,

$$\mu = \mu_{\text{ref}} \left(\frac{T}{T_{\text{ref}}} \right)^{3/2} \frac{T_{\text{ref}} + T_s}{T + T_s},$$

where T_s is the Sutherland's Law constant, and μ_{ref} and T_{ref} are the reference viscosity and temperature, respectively. For air³, the power-law exponent is $n = 0.666$, Sutherland's law constant (T_s) is 110.6 K, the reference temperature (T_{ref}) is 273.15 K, and the reference viscosity (μ_{ref}) is 1.716×10^{-5} kg/(m-s). The data-name identifiers for molecular viscosity models are defined in Table 11.

Table 11: Data-Name Identifiers for Molecular Viscosity Models

ViscosityModelType	Data-Name Identifier	Description	Units
PowerLaw	PowerLawExponent	Power-law exponent (n)	-
SutherlandLaw	SutherlandLawConstant	Sutherland's Law constant (T_s)	Θ
All	TemperatureReference	Reference temperature (T_{ref})	Θ
All	ViscosityMolecularReference	Reference viscosity (μ_{ref})	M/(LT)

If it is desired to specify any of these identifiers in a CGNS database, they should be defined as `DataArrays` under `ViscosityModel_t`.

³White, F. M., *Viscous Fluid Flow*, McGraw-Hill, 1974, p. 28-29

`DataClass` defines the default for the class of data contained in the molecular viscosity model. For any data that is dimensional, `DimensionalUnits` may be used to describe the system of dimensional units employed. If present, these two entities take precedence over all corresponding entities at higher levels of the hierarchy. These precedence rules are further discussed in [Section 6.4](#).

The `UserDefinedData_t` data structure allows arbitrary user-defined data to be stored in `Descriptor_t` and `DataArray_t` children without the restrictions or implicit meanings imposed on these node types at other node locations.

10.6 Thermal Conductivity Model Structure Definition: `ThermalConductivityModel_t`

`ThermalConductivityModel_t` describes the model for relating the thermal-conductivity coefficient (k) to temperature. The enumerated values for `ThermalConductivityModelType_t` are a subset of the `ModelType_t` enumeration.

```
ThermalConductivityModelType_t := Enumeration(  
    ModelTypeNull,  
    ModelTypeUserDefined,  
    ConstantPrandtl,  
    PowerLaw,  
    SutherlandLaw ) ;  
  
ThermalConductivityModel_t :=  
{  
    List( Descriptor_t Descriptor1 ... DescriptorN ) ;           (o)  
  
    ThermalConductivityModelType_t ThermalConductivityModelType ;   (r)  
  
    List( DataArray_t<DataType, 1, 1> DataArray1 ... DataArrayN ) ;   (o)  
  
    DataClass_t DataClass ;                                           (o)  
  
    DimensionalUnits_t DimensionalUnits ;                             (o)  
  
    List( UserDefinedData_t UserDefinedData1 ... UserDefinedDataN ) ; (o)  
} ;
```

Notes

1. Default names for the `Descriptor_t` and `DataArray_t` `UserDefinedData_t` lists are as shown; users may choose other legitimate names. Legitimate names must be unique within a given instance of `ThermalConductivityModel_t` and shall not include the names `DataClass` or `DimensionalUnits`.
2. `ThermalConductivityModelType` is the only required element.

The thermal-conductivity models parallel the molecular viscosity models. `ConstantPrandtl` states that the Prandtl number ($Pr = \mu c_p/k$) is constant and equal to some reference value. `PowerLaw` relates k to temperature via a power-law relation,

$$k = k_{\text{ref}} \left(\frac{T}{T_{\text{ref}}} \right)^n.$$

`SutherlandLaw` states the Sutherland's Law for thermal conductivity,

$$k = k_{\text{ref}} \left(\frac{T}{T_{\text{ref}}} \right)^{3/2} \frac{T_{\text{ref}} + T_s}{T + T_s},$$

where k_{ref} is the reference thermal conductivity, T_{ref} is the reference temperature, and T_s is the Sutherland's law constant. For air⁴, the Prandtl number is $Pr = 0.72$, the power-law exponent is $n = 0.81$, Sutherland's law constant (T_s) is 194.4 K, the reference temperature (T_{ref}) is 273.15 K, and the reference thermal conductivity (k_{ref}) is 2.414×10^{-2} kg-m/(s³-K). Data-name identifiers for thermal conductivity models are listed in [Table 12](#).

Table 12: Data-Name Identifiers for Thermal Conductivity Models

ThermalConductivityModelType	Data-Name Identifier	Description	Units
<code>ConstantPrandtl</code>	<code>Prandtl</code>	Prandtl number (Pr)	-
<code>PowerLaw</code>	<code>PowerLawExponent</code>	Power-law exponent (n)	-
<code>SutherlandLaw</code>	<code>SutherlandLawConstant</code>	Sutherland's Law constant (T_s)	Θ
<i>All</i>	<code>TemperatureReference</code>	Reference temperature (T_{ref})	Θ
<i>All</i>	<code>ThermalConductivityReference</code>	Reference thermal conductivity (k_{ref})	$\text{ML}/(\text{T}^3\Theta)$

If it is desired to specify any of these identifiers in a CGNS database, they should be defined as `DataArrays` under `ThermalConductivityModel_t`.

`DataClass` defines the default for the class of data contained in the thermal conductivity model. For any data that is dimensional, `DimensionalUnits` may be used to describe the system of dimensional units employed. If present, these two entities take precedence over all corresponding entities at higher levels of the hierarchy. These precedence rules are further discussed in [Section 6.4](#).

The `UserDefinedData_t` data structure allows arbitrary user-defined data to be stored in `Descriptor_t` and `DataArray_t` children without the restrictions or implicit meanings imposed on these node types at other node locations.

⁴White, F. M., *Viscous Fluid Flow*, McGraw-Hill, 1974, p. 32-33

10.7 Turbulence Structure Definitions

This section presents structure definitions for describing the form of closure used in the Reynolds-averaged (or Favre-averaged) Navier-Stokes equations for determining the Reynolds stress terms. Here “turbulence closure” refers to eddy viscosity or other approximations for the Reynolds stress terms, and “turbulence model” refers to the actual algebraic or turbulence-transport equation models used. To an extent these are independent choices (e.g., using either an eddy viscosity closure or an algebraic Reynolds-stress closure with a two-equation model).

10.7.1 Turbulence Closure Structure Definition: `TurbulenceClosure_t`

`TurbulenceClosure_t` describes the turbulence closure for the Reynolds stress terms of the Navier-Stokes equations. The enumerated values for `TurbulenceClosureType_t` are a subset of the `ModelType_t` enumeration.

```
TurbulenceClosureType_t := Enumeration(  
    ModelTypeNull,  
    ModelTypeUserDefined,  
    EddyViscosity,  
    ReynoldsStress,  
    ReynoldsStressAlgebraic ) ;  
  
TurbulenceClosure_t :=  
{  
    List( Descriptor_t Descriptor1 ... DescriptorN ) ;           (o)  
  
    TurbulenceClosureType_t TurbulenceClosureType ;           (r)  
  
    List( DataArray_t<DataType, 1, 1> DataArray1 ... DataArrayN ) ;   (o)  
  
    DataClass_t DataClass ;                                         (o)  
  
    DimensionalUnits_t DimensionalUnits ;                           (o)  
  
    List( UserDefinedData_t UserDefinedData1 ... UserDefinedDataN ) ;   (o)  
} ;
```

Notes

1. Default names for the `Descriptor_t`, `DataArray_t`, and `UserDefinedData_t` lists are as shown; users may choose other legitimate names. Legitimate names must be unique within a given instance of `TurbulenceClosure_t` and shall not include the names `DataClass` or `DimensionalUnits`.
2. `TurbulenceClosureType` is the only required element.

The different types of turbulent closure are as follows: `EddyViscosity` is the Boussinesq eddy-viscosity closure, where the Reynolds stresses are approximated as the product of an eddy viscosity (ν_t) and the mean strain tensor. Using indicial notation, the relation is,

$$-\overline{u'_i u'_j} = \nu_t \left(\frac{\partial u_i}{\partial x_j} + \frac{\partial u_j}{\partial x_i} \right),$$

where $-\overline{u'_i u'_j}$ are the Reynolds stresses; the notation is further discussed in [Appendix A.2](#). `ReynoldsStress` is no approximation of the Reynolds stresses. `ReynoldsStressAlgebraic` is an algebraic approximation for the Reynolds stresses based on some intermediate transport quantities.

Associated with the turbulent closure is a list of constants, where each constant is described by a separate `DataArray_t` entity. Constants associated with the eddy-viscosity closure are listed in [Table 13](#).

Table 13: Data-Name Identifiers for Turbulence Closure

Data-Name Identifier	Description	Units
<code>PrandtlTurbulent</code>	Turbulent Prandtl number ($\rho\nu_t c_p/k_t$)	-

If it is desired to specify any of these identifiers in a CGNS database, they should be defined as `DataArrays` under `TurbulenceClosure_t`.

`DataClass` defines the default for the class of data contained in the turbulence closure. For any data that is dimensional, `DimensionalUnits` may be used to describe the system of dimensional units employed. If present, these two entities take precedence over all corresponding entities at higher levels of the hierarchy. These precedence rules are further discussed in [Section 6.4](#).

The `UserDefinedData_t` data structure allows arbitrary user-defined data to be stored in `Descriptor_t` and `DataArray_t` children without the restrictions or implicit meanings imposed on these node types at other node locations.

10.7.2 Turbulence Model Structure Definition: `TurbulenceModel_t`

`TurbulenceModel_t` describes the equation set used to model the turbulence quantities. The enumerated values for `TurbulenceModelType_t` are a subset of the `ModelType_t` enumeration.

```
TurbulenceModelType_t := Enumeration(
  ModelTypeNull,
  ModelTypeUserDefined,
  Algebraic_BaldwinLomax,
  Algebraic_CebeciSmith,
  HalfEquation_JohnsonKing,
  OneEquation_BaldwinBarth,
  OneEquation_SpalartAllmaras,
```

```
TwoEquation_JonesLaunder,  
TwoEquation_MenterSST,  
TwoEquation_Wilcox ) ;  
  
TurbulenceModel_t< int CellDimension > :=  
{  
List( Descriptor_t Descriptor1 ... DescriptorN ) ;           (o)  
  
TurbulenceModelType_t TurbulenceModelType ;                 (r)  
  
List( DataArray_t<DataType, 1, 1> DataArray1 ... DataArrayN ) ; (o)  
  
int[CellDimension*(CellDimension + 1)/2] DiffusionModel ;   (o)  
  
DataClass_t DataClass ;                                     (o)  
  
DimensionalUnits_t DimensionalUnits ;                       (o)  
  
List( UserDefinedData_t UserDefinedData1 ... UserDefinedDataN ) ; (o)  
} ;
```

Notes

1. Default names for the `Descriptor_t` and `DataArray_t` `UserDefinedData_t` lists are as shown; users may choose other legitimate names. Legitimate names must be unique within a given instance of `TurbulenceModel_t` and shall not include the names `DiffusionModel`, `DataClass`, or `DimensionalUnits`.
2. `TurbulenceModelType` is the only required element.
3. The length of the `DiffusionModel` array is as follows: in 1-D it is `int[1]`; in 2-D it is `int[3]`; and in 3-D it is `int[6]`. For unstructured zones, `DiffusionModel` is not supported, and should not be used.

`TurbulenceModel_t` requires a single structure parameter, `CellDimension`. It is used to define the length of the array `DiffusionModel`. `DiffusionModel` describes the viscous diffusion terms included in the turbulent transport model equations; the encoding of `DiffusionModel` is described in [Section 10.2](#).

The `TurbulenceModelType` names currently listed correspond to the following particular references.

<code>Algebraic_BaldwinLomax</code>	Baldwin, B. S., and Lomax, H. (1978) "Thin Layer Approximations and Algebraic Model for Separated Turbulent Flows," AIAA Paper 78-257.
<code>Algebraic_CebeciSmith</code>	Cebeci, T., and Smith, A. M. O. (1974) <i>Analysis of Turbulent Boundary Layers</i> , Academic Press, New York.

<code>HalfEquation_JohnsonKing</code>	Johnson, D., and King, L. (1985) “A Mathematically Simple Turbulence Closure Model for Attached and Separated Turbulent Boundary Layers,” <i>AIAA Journal</i> , Vol. 23, No. 11, pp. 1684–1692.
<code>OneEquation_BaldwinBarth</code>	Baldwin, B., and Barth, T. (1990) “A One-Equation Turbulent Transport Model for High Reynolds Number Wall-Bounded Flows,” NASA TM-102847.
<code>OneEquation_SpalartAllmaras</code>	Spalart, P. R., and Allmaras, S. R. (1994) “A One-Equation Turbulence Model for Aerodynamic Flows,” <i>La Recherche Aeronautique</i> , Vol. 1, pp. 5–21.
<code>TwoEquation_JonesLaunder</code>	Jones, W., and Launder, B. (1972) “The Prediction of Laminarization with a Two-Equation Model of Turbulence,” <i>International Journal of Heat and Mass Transfer</i> , Vol. 15, pp. 301–314.
<code>TwoEquation_MenterSST</code>	Menter, F. R. (1994) “Two-Equation Eddy-Viscosity Turbulence Models for Engineering Application,” <i>AIAA Journal</i> , Vol. 32, No. 8, pp. 1598–1605.
<code>TwoEquation_Wilcox</code>	Wilcox, D. C. (1994) <i>Turbulence Modeling for CFD</i> , First Edition, DCW Industries, La Canada, California.

There is no formal mechanism for accounting for subsequent changes to these models. (For example, Wilcox later published 1998 and 2006 versions of his $k-\omega$ model). If it is a mere change to constant(s), then this could be described by retaining the same `TurbulenceModelType` name and listing each constant using a separate `DataArray_t` entry. If the change is more involved, then it is recommended to employ `TurbulenceModelType = UserDefined` with a child `Descriptor_t` node giving details about it.

Associated with each choice of turbulence model may be a list of constants, where each constant is described by a separate `DataArray_t` entity. If used, the Data-Name Identifier of each constant should include the turbulence model name, as well as the constant name (e.g., `TurbulentSACb1`, `TurbulentSSTCmu`, `TurbulentKESigmaK`, etc.). However, no attempt is made here to formalize the names for all possible turbulence models.

`DataClass` defines the default for the class of data contained in the turbulence model equation set. For any data that is dimensional, `DimensionalUnits` may be used to describe the system of dimensional units employed. If present, these two entities take precedence over all corresponding entities at higher levels of the hierarchy. These precedence rules are further discussed in [Section 6.4](#).

The `UserDefinedData_t` data structure allows arbitrary user-defined data to be stored in `Descriptor_t` and `DataArray_t` children without the restrictions or implicit meanings imposed on these node types at other node locations.

Example 10-A: Spalart-Allmaras Turbulence Model

Description for the eddy-viscosity closure and Spalart-Allmaras turbulence model, including associated constants.

```
TurbulenceClosure_t TurbulenceClosure =
  {{
    TurbulenceClosureType_t TurbulenceClosureType = EddyViscosity ;

    DataArray_t<real, 1, 1> PrandtlTurbulent = {{ 0.90 }} ;
  }} ;

TurbulenceModel_t TurbulenceModel =
  {{
    TurbulenceModelType_t TurbulenceModelType = OneEquation_SpalartAllmaras ;

    DataArray_t<real, 1, 1> TurbulentSACb1 = {{ 0.1355 }} ;
    DataArray_t<real, 1, 1> TurbulentSACb2 = {{ 0.622 }} ;
    DataArray_t<real, 1, 1> TurbulentSASigma = {{ 2/3 }} ;
    DataArray_t<real, 1, 1> TurbulentSAKappa = {{ 0.41 }} ;
    DataArray_t<real, 1, 1> TurbulentSACw1 = {{ 3.2391 }} ;
    DataArray_t<real, 1, 1> TurbulentSACw2 = {{ 0.3 }} ;
    DataArray_t<real, 1, 1> TurbulentSACw3 = {{ 2 }} ;
    DataArray_t<real, 1, 1> TurbulentSACv1 = {{ 7.1 }} ;
    DataArray_t<real, 1, 1> TurbulentSACt1 = {{ 1 }} ;
    DataArray_t<real, 1, 1> TurbulentSACt2 = {{ 2 }} ;
    DataArray_t<real, 1, 1> TurbulentSACt3 = {{ 1.2 }} ;
    DataArray_t<real, 1, 1> TurbulentSACt4 = {{ 0.5 }} ;
  }} ;
```

Note that each `DataArray_t` entity is abbreviated.

10.8 Thermal Relaxation Model Structure Definition: ThermalRelaxationModelType_t

`ThermalRelaxationModel_t` describes the equation set used to model thermal relaxation quantities. The enumerated values for `ThermalRelaxationModelType_t` are a subset of the `ModelType_t` enumeration.

```
ThermalRelaxationModelType_t := Enumeration(
  ModelTypeNull,
  ModelTypeUserDefined,
  Frozen,
  ThermalEquilib,
  ThermalNonequilib ) ;
```

```

ThermalRelaxationModel_t :=
{
  List( Descriptor_t Descriptor1 ... DescriptorN ) ;           (o)

  ThermalRelaxationModelType_t ThermalRelaxationModelType ; (r)

  List( DataArray_t<DataType, 1, 1> DataArray1 ... DataArrayN ) ; (o)

  DataClass_t DataClass ;                                     (o)

  DimensionalUnits_t DimensionalUnits ;                     (o)

  List( UserDefinedData_t UserDefinedData1 ... UserDefinedDataN ) ; (o)
} ;

```

Notes

1. Default names for the `Descriptor_t`, `DataArray_t`, and `UserDefinedData_t` lists are as shown; users may choose other legitimate names. Legitimate names must be unique within a given instance of `ThermalRelaxationModel_t` and shall not include the names `DataClass` or `DimensionalUnits`.
2. `ThermalRelaxationModelType` is the only required element.

`ThermalRelaxationModelType_t` is an enumeration type describing the type of thermal relaxation model.

`DataArray_t` data structures may be used to store data associated with the thermal relaxation model. `DataClass` defines the default for the class of data being used. For any data that is dimensional, `DimensionalUnits` may be used to describe the system of dimensional units employed. If present, these two entities take precedence over all corresponding entities at higher levels of the hierarchy. These precedence rules are further discussed in [Section 6.4](#).

Additional information, if needed, may be stored using `Descriptor_t` data structures.

The `UserDefinedData_t` data structure allows arbitrary user-defined data to be stored in `Descriptor_t` and `DataArray_t` children without the restrictions or implicit meanings imposed on these node types at other node locations.

10.9 Chemical Kinetics Structure Definition: `ChemicalKineticsModel_t`

`ChemicalKineticsModel_t` describes the equation set used to model chemical kinetics quantities. The enumerated values for `ChemicalKineticsModelType_t` are a subset of the `ModelType_t` enumeration.

```

ChemicalKineticsModelType_t := Enumeration(
  ModelTypeNull,

```

```
ModelTypeUserDefined,  
Frozen,  
ChemicalEquilibCurveFit,  
ChemicalEquilibMinimization,  
ChemicalNonequilib ) ;  
  
ChemicalKineticsModel_t :=  
{  
List( Descriptor_t Descriptor1 ... DescriptorN ) ;           (o)  
  
ChemicalKineticsModelType_t ChemicalKineticsModelType ;   (r)  
  
List( DataArray_t<DataType, 1, 1> DataArray1 ... DataArrayN ) ; (o)  
  
DataClass_t DataClass ;                                     (o)  
  
DimensionalUnits_t DimensionalUnits ;                       (o)  
  
List( UserDefinedData_t UserDefinedData1 ... UserDefinedDataN ) ; (o)  
} ;
```

Notes

1. Default names for the `Descriptor_t`, `DataArray_t`, and `UserDefinedData_t` lists are as shown; users may choose other legitimate names. Legitimate names must be unique within a given instance of `ChemicalKineticsModel_t` and shall not include the names `DataClass` or `DimensionalUnits`.
2. `ChemicalKineticsModelType` is the only required element.

`ChemicalKineticsModelType_t` is an enumeration type describing the type of chemical kinetics model.

`DataArray_t` data structures may be used to store data associated with the chemical kinetics model. Recommended data-name identifiers are listed in [Table 14](#).

Table 14: Data-Name Identifiers for Chemical Kinetics Models

Data-Name Identifier	Description	Units
<code>MolecularWeightSymbol</code>	Molecular weight for species <i>Symbol</i>	-
<code>HeatOfFormationSymbol</code>	Heat of formation per unit mass for species <i>Symbol</i>	L^2/T^2
<code>FuelAirRatio</code>	Fuel/air mass ratio	-
<code>ReferenceTemperatureHOF</code>	Reference temperature for the heat of formation	Θ

The dimensional units are defined as follows: **L** is length, **T** is time and Θ is temperature. These are further described in [Appendix A](#).

The variable string *Symbol* in the above data-name identifiers represents the chemical symbol for the desired species. For example, **H** represents hydrogen atoms, **O** represents oxygen atoms, **H2** represents hydrogen molecules, **H2O** represents water molecules, and **C3H5O3(NO2)3** represents nitroglycerin molecules. Any symbols from the periodic table of the elements can be used. For charged molecules or particles, the word “plus” or “minus” should be spelled out in lower case. For example, a **CNO+** molecule should be denoted as **CNOplus**.

Other commonly used mixtures that are usually not referred to by their chemical symbols, are defined in [Table 15](#). Individual users may define new names, but these may not be recognized by other CGNS applications. For consistency, additional names should be proposed as SIDS extensions.

Table 15: Defined Names (Symbols) for Commonly Used Mixtures

Symbol	Mixture
Air	Generic air model
eminus	Electrons
Fuel	Generic fuel model
FuelAir	Generic fuel/air mixture
JP5	JP5 jet fuel
JP7	JP7 jet fuel
JP10	JP10 jet fuel
Product	Generic fuel/air product of combustion
RP1	RP1 rocket fuel

DataClass defines the default for the class of data being used. For any data that is dimensional, **DimensionalUnits** may be used to describe the system of dimensional units employed. If present, these two entities take precedence over all corresponding entities at higher levels of the hierarchy, following the standard precedence rules.

Additional information, if needed, may be stored using **Descriptor_t** data structures. For example, if CHEMKIN is used, it is recommended that a **Descriptor_t** data structure be used to indicate this. Reaction equations could also be specified using **Descriptor_t** data structures.

The **UserDefinedData_t** data structure allows arbitrary user-defined data to be stored in **Descriptor_t** and **DataArray_t** children without the restrictions or implicit meanings imposed on these node types at other node locations.

10.10 Electromagnetics Structure Definitions

This section presents structure definitions for describing the electric field, magnetic field, and conductivity models used for electromagnetic flows.

10.10.1 Electromagnetics Electric Field Model Structure Definition: EMElectricFieldModel_t

EMElectricFieldModel_t describes the electric field model used for electromagnetic flows. The enumerated values for EMElectricFieldModelType_t are a subset of the ModelType_t enumeration.

```
EMElectricFieldModelType_t := Enumeration(  
    ModelTypeNull,  
    ModelTypeUserDefined,  
    Constant,  
    Frozen,  
    Interpolated,  
    Voltage ) ;  
  
EMElectricFieldModel_t :=  
    {  
    List( Descriptor_t Descriptor1 ... DescriptorN ) ;           (o)  
  
    EMElectricFieldModelType_t EMElectricFieldModelType ;    (r)  
  
    List( DataArray_t<DataType, 1, 1> DataArray1 ... DataArrayN ) ; (o)  
  
    DataClass_t DataClass ;                                   (o)  
  
    DimensionalUnits_t DimensionalUnits ;                   (o)  
  
    List( UserDefinedData_t UserDefinedData1 ... UserDefinedDataN ) ; (o)  
    } ;
```

Notes

1. Default names for the Descriptor_t, DataArray_t, and UserDefinedData_t lists are as shown; users may choose other legitimate names. Legitimate names must be unique within a given instance of EMElectricFieldModel_t and shall not include the names DataClass or DimensionalUnits.
2. EMElectricFieldModelType is the only required element.

EMElectricFieldModelType_t is an enumeration type describing the type of electric field model. DataArray_t data structures may be used to store data associated with the electric field model. Recommended data-name identifiers are listed in [Table 16](#).

DataClass defines the default for the class of data contained in the electric field model. For any data that is dimensional, DimensionalUnits may be used to describe the system of dimensional units employed. If present, these two entities take precedence over all corresponding entities at higher levels of the hierarchy, following the standard precedence rules.

The `UserDefinedData_t` data structure allows arbitrary user-defined data to be stored in `Descriptor_t` and `DataArray_t` children without the restrictions or implicit meanings imposed on these node types at other node locations.

10.10.2 Electromagnetics Magnetic Field Model Structure Definition: `EMMagneticFieldModel_t`

`EMMagneticFieldModel_t` describes the magnetic field model used for electromagnetic flows. The enumerated values for `EMMagneticFieldModelType_t` are a subset of the `ModelType_t` enumeration.

```
EMMagneticFieldModelType_t := Enumeration(
  ModelTypeNull,
  ModelTypeUserDefined,
  Constant,
  Frozen,
  Interpolated ) ;

EMMagneticFieldModel_t :=
{
  List( Descriptor_t Descriptor1 ... DescriptorN ) ;           (o)

  EMMagneticFieldModelType_t EMMagneticFieldModelType ;     (r)

  List( DataArray_t<DataType, 1, 1> DataArray1 ... DataArrayN ) ; (o)

  DataClass_t DataClass ;                                     (o)

  DimensionalUnits_t DimensionalUnits ;                       (o)

  List( UserDefinedData_t UserDefinedData1 ... UserDefinedDataN ) ; (o)
} ;
```

Notes

1. Default names for the `Descriptor_t`, `DataArray_t`, and `UserDefinedData_t` lists are as shown; users may choose other legitimate names. Legitimate names must be unique within a given instance of `EMMagneticFieldModel_t` and shall not include the names `DataClass` or `DimensionalUnits`.
2. `EMMagneticFieldModelType` is the only required element.

`EMMagneticFieldModelType_t` is an enumeration type describing the type of magnetic field model. `DataArray_t` data structures may be used to store data associated with the magnetic field model. Recommended data-name identifiers are listed in [Table 16](#).

`DataClass` defines the default for the class of data contained in the electric field model. For any data that is dimensional, `DimensionalUnits` may be used to describe the system of dimensional units employed. If present, these two entities take precedence over all corresponding entities at higher levels of the hierarchy, following the standard precedence rules.

The `UserDefinedData_t` data structure allows arbitrary user-defined data to be stored in `Descriptor_t` and `DataArray_t` children without the restrictions or implicit meanings imposed on these node types at other node locations.

10.10.3 Electromagnetics Conductivity Model Structure Definition: `EMConductivityModel_t`

`EMConductivityModel_t` describes the conductivity model used for electromagnetic flows. The enumerated values for `EMConductivityModelType_t` are a subset of the `ModelType_t` enumeration.

```
EMConductivityModelType_t := Enumeration(  
    ModelTypeNull,  
    ModelTypeUserDefined,  
    Constant,  
    Frozen,  
    Equilibrium_LinRessler,  
    Chemistry_LinRessler ) ;  
  
EMConductivityModel_t :=  
{  
    List( Descriptor_t Descriptor1 ... DescriptorN ) ;           (o)  
  
    EMConductivityModelType_t EMConductivityModelType ;      (r)  
  
    List( DataArray_t<DataType, 1, 1> DataArray1 ... DataArrayN ) ; (o)  
  
    DataClass_t DataClass ;                                     (o)  
  
    DimensionalUnits_t DimensionalUnits ;                     (o)  
  
    List( UserDefinedData_t UserDefinedData1 ... UserDefinedDataN ) ; (o)  
} ;
```

Notes

1. Default names for the `Descriptor_t`, `DataArray_t`, and `UserDefinedData_t` lists are as shown; users may choose other legitimate names. Legitimate names must be unique within a given instance of `EMConductivityModel_t` and shall not include the names `DataClass` or `DimensionalUnits`.
2. `EMConductivityModelType` is the only required element.

EMConductivityModelType_t is an enumeration type describing the type of conductivity model. DataArray_t data structures may be used to store data associated with the conductivity model. Recommended data-name identifiers are listed in Table 16.

Table 16: Data-Name Identifiers for Electromagnetics Models

Data-Name Identifier	Description	Units
Voltage	Voltage	ML^2/TI
ElectricFieldX	x -component of electric field vector	ML/TI
ElectricFieldY	y -component of electric field vector	ML/TI
ElectricFieldZ	z -component of electric field vector	ML/TI
MagneticFieldX	x -component of magnetic field vector	I/L
MagneticFieldY	y -component of magnetic field vector	I/L
MagneticFieldZ	z -component of magnetic field vector	I/L
CurrentDensityX	x -component of current density vector	I/L^2
CurrentDensityY	y -component of current density vector	I/L^2
CurrentDensityZ	z -component of current density vector	I/L^2
ElectricConductivity	Electrical conductivity	$\text{ML}/\text{T}^3\text{I}^2$
LorentzForceX	x -component of Lorentz force vector	ML/T^2
LorentzForceY	y -component of Lorentz force vector	ML/T^2
LorentzForceZ	z -component of Lorentz force vector	ML/T^2
JouleHeating	Joule heating	ML^2/T^2

The dimensional units are defined as follows: **M** is mass, **L** is length, **T** is time, and **I** is electric current. These are further described in Appendix A.

DataClass defines the default for the class of data contained in the conductivity model. For any data that is dimensional, DimensionalUnits may be used to describe the system of dimensional units employed. If present, these two entities take precedence over all corresponding entities at higher levels of the hierarchy, following the standard precedence rules.

The UserDefinedData_t data structure allows arbitrary user-defined data to be stored in Descriptor_t and DataArray_t children without the restrictions or implicit meanings imposed on these node types at other node locations.

10.11 Flow Equation Examples

This section presents two examples of flow-equation sets. The first is an inviscid case and the second is a turbulent case with a one-equation turbulence model.

Example 10-B: 3-D Compressible Euler

3-D compressible Euler with a perfect gas assumption for a monatomic gas:

```
FlowEquationSet_t<3> EulerEquations =
```

```
{ {
int EquationDimension = 3 ;

GoverningEquations_t<3> GoverningEquations =
  { {
    GoverningEquationsType_t GoverningEquationsType = Euler ;
  } } ;

GasModel_t GasModel =
  { {
    GasModelType_t GasModelType = CaloricallyPerfect ;

    DataArray_t<real, 1, 1> SpecificHeatRatio =
      { {
        Data(real, 1, 1) = 1.667 ;

        DataClass_t DataClass = NondimensionalParameter ;
      } } ;
  } } ;
} } ;
```

Example 10-C: 3-D Compressible Navier-Stokes

3-D compressible Navier-Stokes for a structured grid, with the S-A turbulence model, a perfect gas assumption, Sutherland's law for the molecular viscosity, a constant Prandtl-number assumption, and inclusion of the full Navier-Stokes diffusion terms; all models assume air:

```
FlowEquationSet_t<3> NSEquations =
  { {
    int EquationDimension = 3 ;

    GoverningEquations_t<3> GoverningEquations =
      { {
        GoverningEquationsType_t GoverningEquationsType = NSTurbulent ;

        int[6] DiffusionModel = [1,1,1,1,1,1] ;
      } } ;

    GasModel_t GasModel =
      { {
        GasModelType_t GasModelType = CaloricallyPerfect ;

        DataArray_t<real, 1, 1> SpecificHeatRatio = { { 1.4 } } ;
      } } ;
  } } ;
```

```

ViscosityModel_t ViscosityModel =
  {{
    ViscosityModelType_t ViscosityModelType = SutherlandLaw ;

    DataArray_t<real, 1, 1> SutherlandLawConstant =
      {{
        Data(real, 1, 1) = 110.6 }} ;

    DataClass_t DataClass = Dimensional ;
    DimensionalUnits_t DimensionalUnits = {{ TemperatureUnits = Kelvin }} ;
  }} ;

ThermalConductivityModel_t ThermalConductivityModel =
  {{
    ThermalConductivityModelType_t ThermalConductivityModelType =
      ConstantPrandtl ;

    DataArray_t<real, 1, 1> Prandtl = {{ 0.72 }} ;
  }} ;

TurbulenceClosure_t<3> TurbulenceClosure =
  {{
    TurbulenceClosureType_t TurbulenceClosureType = EddyViscosity ;

    DataArray_t<real, 1, 1> PrandtlTurbulent = {{ 0.90 }} ;
  }} ;

TurbulenceModel_t<3> TurbulenceModel =
  {{
    TurbulenceModelType_t TurbulenceModelType = OneEquation_SpalartAllmaras ;

    int[6] DiffusionModel = [1,1,1,1,1,1] ;
  }} ;
}} ;

```

Note that all `DataArray_t` entities are abbreviated except `SutherlandLawConstant`.

11 Time-Dependent Flow

This section describes structure types intended primarily for time-dependent flows. Data structures are presented for storing time-dependent or iterative data, and for recording rigid and arbitrary grid motion. The section concludes with several examples.

11.1 Iterative Data Structure Definitions

In order to keep a record of time dependent or iterative data, the data structures `BaseIterativeData_t` and `ZoneIterativeData_t` are used.

11.1.1 Base Iterative Data Structure Definition: `BaseIterativeData_t`

The `BaseIterativeData_t` data structure is located directly under the `CGNSBase_t` node. It contains information about the number of time steps or iterations being recorded, and the time and/or iteration values at each step. In addition, it may include the list of zones and families for each step of the simulation, if these vary throughout the simulation.

The `BaseIterativeData_t` data structure is defined as follows:

```
BaseIterativeData_t :=
{
  int NumberOfSteps                                     (r)

  DataArray_t<real, 1, NumberOfSteps> TimeValues ;     (o/r)
  DataArray_t<int, 1, NumberOfSteps> IterationValues ; (r/o)

  DataArray_t<int, 1, NumberOfSteps> NumberOfZones ;  (o)
  DataArray_t<int, 1, NumberOfSteps> NumberOfFamilies ; (o)
  DataArray_t<char, 3, [65, MaxNumberOfZones, NumberOfSteps]>
    ZonePointers ;                                     (o)
  DataArray_t<char, 3, [65, MaxNumberOfFamilies, NumberOfSteps]>
    FamilyPointers ;                                   (o)

  List( DataArray_t<> dataArray1 ... dataArrayN ) ;    (o)

  List( Descriptor_t Descriptor1 ... DescriptorN ) ;  (o)

  DataClass_t DataClass ;                             (o)

  DimensionalUnits_t DimensionalUnits ;              (o)

  List( UserDefinedData_t UserDefinedData1 ... UserDefinedDataN ) ; (o)
}
```

Notes

1. Default names for the `DataArray_t`, `Descriptor_t`, and `UserDefinedData_t` lists are as shown; users may choose other legitimate names. Legitimate names must be unique within a given instance of `BaseIterativeData_t` and shall not include the names `DataClass`, `DimensionalUnits`, `FamilyPointers`, `IterationValues`, `NumberOfFamilies`, `NumberOfZones`, `TimeValues`, or `ZonePointers`.
2. `NumberOfSteps` is a required element of the `BaseIterativeData_t` data structure. It holds either the number of time steps or the number of iterations being recorded.
3. Either `TimeValues` or `IterationValues` must be defined. If both are used, there must be a one-to-one correspondence between them.

`TimeValues` and `IterationValues` are data-name identifiers corresponding to the time and iteration values stored in the file. When `IterationValues` are used, the iterative data stored in the database correspond to values at the end of the associated iteration.

The data-name identifiers `NumberOfZones` and `ZonePointers` are only used if different zone data structures apply to different steps of the simulation. (See [Example 11-C](#).)

Similarly, if the geometry varies with time or iteration, then the data-name identifiers `NumberOfFamilies` and `FamilyPointers` are used to record which `Family_t` data structure(s) correspond(s) to which step.

The `DataArray_t` nodes for `ZonePointers` and `FamilyPointers` are defined as three-dimensional arrays. For each recorded step, the names of all zones and families being used for the step may be recorded. Note that the names are limited to 65 characters; this is the maximum size of a name of a zone from another base: 32 chars + '/' + 32 chars. Only one '/' character is allowed, then the first token before the '/' is the CGNSBase name and the second token is the Zone or Family name. If no '/' is found, the name is a Zone or a Family name of the current CGNS Base. The variables `MaxNumberOfZones` and `MaxNumberOfFamilies` represent the maximum number of zones and families that apply to one step. So if `NumberOfSteps` = 5 and `NumberOfZones` = {2,2,3,4,3}, then `MaxNumberOfZones` equals 4.

When `NumberOfZones` and `NumberOfFamilies` vary for different stored time steps, the name `Null` is used in `ZonePointers` and `FamilyPointers` as appropriate for steps in which the `NumberOfZones` or `NumberOfFamilies` is less than the `MaxNumberOfZones` or `MaxNumberOfFamilies`.

Any number of extra `DataArray_t` nodes are allowed. These should be used to record data not covered by this specification.

11.1.2 Zone Iterative Data Structure Definition: `ZoneIterativeData_t`

The `ZoneIterativeData_t` data structure is located under the `Zone_t` node. It may be used to record pointers to zonal data for each recorded step of the simulation, and is defined as follows:

```
ZoneIterativeData_t< int NumberOfSteps > :=  
{  
  DataArray_t<char, 2, [32, NumberOfSteps]> RigidGridMotionPointers ;      (o)
```

```

  DataArray_t<char, 2, [32, NumberOfSteps]> ArbitraryGridMotionPointers ; (o)
  DataArray_t<char, 2, [32, NumberOfSteps]> GridCoordinatesPointers ; (o)
  DataArray_t<char, 2, [32, NumberOfSteps]> FlowSolutionPointers ; (o)
  DataArray_t<char, 2, [32, NumberOfSteps]> ZoneGridConnectivityPointers ;(o)
  DataArray_t<char, 2, [32, NumberOfSteps]> ZoneSubRegionPointers ; (o)

  List( DataArray_t<> DataArray1 ... DataArrayN ) ; (o)

  List( Descriptor_t Descriptor1 ... DescriptorN ) ; (o)

  DataClass_t DataClass ; (o)

  DimensionalUnits_t DimensionalUnits ; (o)

  List( UserDefinedData_t UserDefinedData1 ... UserDefinedDataN ) ; (o)
}

```

Notes

1. Default names for the `DataArray_t`, `Descriptor_t`, and `UserDefinedData_t` lists are as shown; users may choose other legitimate names. Legitimate names must be unique within a given instance of `ZoneIterativeData_t` and shall not include the names `ArbitraryGridMotionPointers`, `DataClass`, `DimensionalUnits`, `FlowSolutionPointers`, `GridCoordinatesPointers`, `RigidGridMotionPointers`, `ZoneGridConnectivityPointers`, or `ZoneSubRegionPointers`.

The data arrays with data-name identifiers `xxxPointers` contain lists of associated data structures for each recorded time value or iteration. These data structures contain data at the associated time value, or at the end of the associated iteration. There is an implied one-to-one correspondence between each pointer (from 1, 2, ..., `NumberOfSteps`) and the associated `TimeValues` and/or `IterationValues` under `BaseIterativeData_t`. They refer by name to data structures within the current zone. The name `Null` is used when a particular time or iteration does not have a corresponding data structure to point to.

Any number of extra `DataArray_t` nodes are allowed. These should be used to record data not covered by this specification.

The `ZoneIterativeData_t` data structure may not exist without the `BaseIterativeData_t` under the `CGNSBase_t` node. However `BaseIterativeData_t` may exist without `ZoneIterativeData_t`.

11.2 Rigid Grid Motion Structure Definition: `RigidGridMotion_t`

Adding rigid grid motion information to the CGNS file enables an application code to determine the mesh location without the need to alter the original mesh definition recorded under `GridCoordinates_t`. A data structure named `RigidGridMotion_t` is used to record the necessary data defining a rigid translation and/or rotation of the grid coordinates.

The rigid grid motion is recorded independently for each zone of the CGNS base. Therefore the `RigidGridMotion_t` data structure is located under the zone data structure (`Zone_t`). There may be zero to several `RigidGridMotion_t` nodes under a `Zone_t` node. The multiple rigid grid motion definitions may be associated with different iterations or time steps in the computation. This association is recorded under the `ZoneIterativeData_t` data structure, described in [Section 11.1.2](#).

```
RigidGridMotion_t :=
{
  List( Descriptor_t Descriptor1 ... DescriptorN ) ;           (o)

  RigidGridMotionType_t RigidGridMotionType ;               (r)

  DataArray_t<real, 2, [PhysicalDimension, 2]> OriginLocation ; (r)
  DataArray_t<real, 1, PhysicalDimension> RigidRotationAngle ; (o/d)
  DataArray_t<real, 1, PhysicalDimension> RigidVelocity ;     (o)
  DataArray_t<real, 1, PhysicalDimension> RigidRotationRate ; (o)

  List( DataArray_t DataArray1 ... DataArrayN ) ;           (o)

  DataClass_t DataClass ;                                   (o)

  DimensionalUnits_t DimensionalUnits ;                     (o)

  List( UserDefinedData_t UserDefinedData1 ... UserDefinedDataN ) ; (o)
} ;
```

Notes

1. Default names for the `Descriptor_t`, `DataArray_t`, and `UserDefinedData_t` lists are as shown; users may choose other legitimate names. Legitimate names must be unique within a given instance of `RigidGridMotion_t` and shall not include the names `DataClass`, `DimensionalUnits`, `OriginLocation`, `RigidGridMotionType`, `RigidRotationAngle`, `RigidRotationRate`, or `RigidVelocity`.
2. `RigidGridMotionType` and `OriginLocation` are the only required elements under `RigidGridMotion_t`. All other elements are optional.

`RigidGridMotionType_t` is an enumeration type that describes the type of rigid grid motion.

```
RigidGridMotionType_t := Enumeration(
  RigidGridMotionTypeNull,
  RigidGridMotionTypeUserDefined,
  ConstantRate,
  VariableRate ) ;
```

Table 17: Data-Name Identifiers for Rigid Grid Motion

Data-Name Identifier	Description	Units
<code>OriginLocation</code>	Physical coordinates of the origin before and after the rigid grid motion	L
<code>RigidRotationAngle</code>	Rotation angles about each axis of the translated coordinate system. If rotating about more than one axis, the rotation is performed first about the x -axis, then the y -axis, then the z -axis. If not specified, <code>RigidRotationAngle</code> is set to zero.	α
<code>RigidVelocity</code>	Grid velocity vector of the origin translation	L/T
<code>RigidRotationRate</code>	Rotation rate vector about the axis of the translated coordinate system	α/T

The characteristics of the grid motion are defined by the data-name identifiers in [Table 17](#).

Any number of additional `DataArray_t` nodes are allowed. These may be used to record data not covered by this specification.

“Rigid grid motion” implies relative motion of grid zones. However, no attempt is made in the `RigidGridMotion_t` data structure to require that the `ZoneGridConnectivity_t` information be updated to be consistent with the new grid locations. Whether the `ZoneGridConnectivity_t` information refers to the original connectivity (of `GridCoordinates`) or the latest connectivity (of the moved or deformed grid) is currently left up to the user.

11.3 Arbitrary Grid Motion Structure Definition: `ArbitraryGridMotion_t`

When a grid is in motion, it is often necessary to account for the position of each grid point as the grid deforms. When all grid points move at the same velocity, the grid keeps its original shape. This particular case of grid motion may be recorded under the `RigidGridMotion_t` data structure described in [Section 11.2](#). On the other hand, if the grid points have different velocity, the grid is deforming. The `ArbitraryGridMotion_t` data structure allows the CGNS file to contain information about arbitrary grid deformations. If not present, the grid is assumed to be rigid.

Note that multiple `GridCoordinates_t` nodes may be stored under a `Zone_t`. This allows the storage of the instantaneous grid locations at different time steps or iterations.

The arbitrary grid motion is recorded independently for each zone of the CGNS base. Therefore the `ArbitraryGridMotion_t` data structure is located under the zone data structure (`Zone_t`). There may be zero to several `ArbitraryGridMotion_t` nodes under a single `Zone_t` node. The multiple arbitrary grid motion definitions may be associated with different iterations or time steps in the computation. This association is recorded under the `ZoneIterativeData_t` data structure, described in [Section 11.1.2](#).

```
ArbitraryGridMotion_t< int IndexDimension, int VertexSize[IndexDimension],
```

```
        int CellSize[IndexDimension] > :=  
{  
ArbitraryGridMotionType_t ArbitraryGridMotionType ;           (r)  
  
List(DataArray_t<real, IndexDimension, DataSize[]>  
    GridVelocityX GridVelocityY ... ) ;                       (o)  
  
List( Descriptor_t Descriptor1 ... DescriptorN ) ;           (o)  
  
GridLocation_t GridLocation ;                                 (o/d)  
  
Rind_t<IndexDimension> Rind ;                                 (o/d)  
  
DataClass_t DataClass ;                                     (o)  
  
DimensionalUnits_t DimensionalUnits ;                       (o)  
  
List( UserDefinedData_t UserDefinedData1 ... UserDefinedDataN ) ; (o)  
}
```

Notes

1. Default names for the `Descriptor_t`, `DataArray_t`, and `UserDefinedData_t` lists are as shown; users may choose other legitimate names. Legitimate names must be unique within a given instance of `ArbitraryGridMotion_t` and shall not include the names `ArbitraryGridMotionType`, `DataClass`, `DimensionalUnits`, `GridLocation`, or `Rind`.
2. The only required element of the `ArbitraryGridMotion_t` data structure is the `ArbitraryGridMotionType`. Thus, even if a deforming grid application does not require the storage of grid velocity data, the `ArbitraryGridMotion_t` node must exist (with `ArbitraryGridMotionType = DeformingGrid`) to indicate that deformed grid points (`GridCoordinates_t`) exist for this zone.
3. `Rind` is an optional field that indicates the number of rind planes (for structured grids) or rind points or elements (for unstructured grids) included in the grid velocity data.
4. The `GridLocation` specifies the location of the velocity data with respect to the grid; if absent, the data is assumed to coincide with grid vertices (i.e., `GridLocation = Vertex`).

`ArbitraryGridMotion_t` requires three structure parameters; `IndexDimension` identifies the dimensionality of the grid-size arrays, and `VertexSize` and `CellSize` are the number of core vertices and cells, respectively, in each index direction. For unstructured zones, `IndexDimension` is always 1.

`ArbitraryGridMotionType_t` is an enumeration type that describes the type of arbitrary grid motion.

```
ArbitraryGridMotionType_t := Enumeration(  

```

```

ArbitraryGridMotionTypeNull,
ArbitraryGridMotionTypeUserDefined,
NonDeformingGrid,
DeformingGrid ) ;

```

The `DataArray_t` nodes are used to store the components of the grid velocity vector. Table 18 lists the data-name identifiers used to record these vectors in Cartesian, cylindrical, and spherical coordinate systems.

Table 18: Data-Name Identifiers for Grid Velocity

Data-Name Identifier	Description	Units
<code>GridVelocityX</code>	x -component of grid velocity	L/T
<code>GridVelocityY</code>	y -component of grid velocity	L/T
<code>GridVelocityZ</code>	z -component of grid velocity	L/T
<code>GridVelocityR</code>	r -component of grid velocity	L/T
<code>GridVelocityTheta</code>	θ -component of grid velocity	α/\mathbf{T}
<code>GridVelocityPhi</code>	ϕ -component of grid velocity	α/\mathbf{T}
<code>GridVelocityXi</code>	ξ -component of grid velocity	L/T
<code>GridVelocityEta</code>	η -component of grid velocity	L/T
<code>GridVelocityZeta</code>	ζ -component of grid velocity	L/T

The field `GridLocation` specifies the location of the grid velocities with respect to the grid; if absent, the grid velocities are assumed to coincide with grid vertices (i.e., `GridLocation = Vertex`). All grid velocities within a given instance of `ArbitraryGridMotion_t` must reside at the same grid location.

`Rind` is an optional field for structured zones that indicates the number of rind planes (for structured grids) or rind points or elements (for unstructured grids) included in the data. Its purpose and function are identical to those described for the `GridCoordinates_t` structure in Section 7.1. Note, however, that the `Rind` in this structure is independent of the `Rind` contained in `GridCoordinates_t` or `FlowSolution_t`. They are not required to contain the same number of rind planes or elements. Also, the location of any rind points is assumed to be consistent with the location of the core data points (e.g., if `GridLocation = CellCenter`, rind points are assumed to be located at fictitious cell centers).

`DataClass` defines the default class for data contained in the `DataArray_t` entities. For dimensional grid velocities, `DimensionalUnits` may be used to describe the system of units employed. If present these two entities take precedence over the corresponding entities at higher levels of the CGNS hierarchy. The rules for determining precedence of entities of this type are discussed in Section 6.4.

Point-by-point grid velocity implies a deformation (or potentially only motion) of the grid points relative to each other. Because the original grid coordinates definition remains unchanged with the

name `GridCoordinates`, any deformed coordinates must be written with a different name (e.g., `MovedGrid#1` or another user-defined name) and are pointed to using `GridCoordinatesPointers` in the data structure `ZoneIterativeData_t`, as described in [Section 11.1.2](#).

The `UserDefinedData_t` data structure allows arbitrary user-defined data to be stored in `Descriptor_t` and `DataArray_t` children without the restrictions or implicit meanings imposed on these node types at other node locations.

Point-by-point grid velocity may also lead to relative motion of grid zones, or movement of grid along abutting interfaces. However, no attempt is made here to require that the `ZoneGridConnectivity_t` information be updated to be consistent with the new grid locations. Whether the `ZoneGridConnectivity_t` information refers to the original connectivity (of `GridCoordinates`) or the latest connectivity (of the moved or deformed grid) is currently left up to the user.

FUNCTION `DataSize[]`:

return value: one-dimensional `int` array of length `IndexDimension`

dependencies: `IndexDimension`, `VertexSize[]`, `CellSize[]`, `GridLocation`, `Rind`

The function `DataSize[]` is the size of the `DataArrays` containing the grid velocity components. It is identical to the function `DataSize[]` defined for `FlowSolution_t` (see [Section 7.7](#)).

11.4 Zone Grid Connectivities

Multiple `ZoneGridConnectivity_t` nodes may be used to specify time-dependent changes in the connectivity information associated with the zone. The time variation is recorded in the `ZoneIterativeData_t` node as `ZoneGridConnectivityPointers`.

11.5 Examples for Time-Dependent Flow

Example 11-A: Rigid Grid Motion

In this example, the whole mesh moves rigidly, so the only time-dependent data are the grid coordinates and flow solutions. However, since the mesh moves rigidly, the grid coordinates need not be recorded at each time step. Instead, a `RigidGridMotion_t` data structure is recorded for each step of the computation.

The number of steps and time values for each step are recorded under `BaseIterativeData_t`.

```
CGNSBase_t {
  BaseIterativeData_t {
    NumberOfSteps = N ;
    TimeValues = time1, time2, ..., timeN ;
  } ;
} ;
```

The multiple rigid grid motion and flow solution data structures are recorded under the zone. `RigidGridMotionPointers` and `FlowSolutionPointers` keep the lists of which `RigidGridMotion_t` and `FlowSolution_t` nodes correspond to each time step.

```

Zone_t Zone {

    --- Time independent data
    GridCoordinates_t GridCoordinates
    ZoneBC_t ZoneBC
    ZoneGridConnectivity_t ZoneGridConnectivity

    --- Time dependent data
    RigidGridMotion_t RigidGridMotion#1
    RigidGridMotion_t RigidGridMotion#2
    ...
    RigidGridMotion_t RigidGridmotion#N

    FlowSolution_t Solution#0
    FlowSolution_t Solution#1
    FlowSolution_t Solution#2
    ...
    FlowSolution_t Solution#N

    ZoneIterativeData_t {
        RigidGridMotionPointers = {"RigidGridMotion#1", "RigidGridMotion#2", ...,
            "RigidGridMotion#N"}
        FlowSolutionPointers = {"Solution#1", "Solution#2, ..., "Solution#N"}
    }
}

```

Note that there may be more solutions under a zone than those pointed to by `FlowSolutionPointers`. In this example, `Solution#0` could correspond to a restart solution.

Example 11-B: Deforming Grid Motion

In this example, velocity vectors are node dependent allowing for mesh deformation. In such a case, it is difficult or even impossible to recompute the mesh at each time step. Therefore the grid coordinates are recorded for each step.

Multiple `GridCoordinates_t` and `FlowSolution_t` data structures are recorded under the zone. In addition, the data structure `ArbitraryGridMotion_t` is recorded for each step. `GridCoordinatesPointers`, `FlowSolutionPointers`, and `ArbitraryGridMotionPointers_t` keep the list of which grid coordinates definition, flow solution, and arbitrary grid motion definition correspond to each time step.

```

Zone_t Zone {

    --- Time independent data
    ZoneBC_t ZoneBC
    ZoneGridConnectivity_t ZoneGridConnectivity

```

```
--- Time dependent data
List ( GridCoordinates_t GridCoordinates MovedGrid#1 MovedGrid#2 ...
      MovedGrid#N )
List ( FlowSolution_t Solution#0 Solution#1 Solution#2 ... Solution#N )
List ( ArbitraryGridMotion_t ArbitraryGridMotion#1
      ArbitraryGridMotion#2 ... ArbitraryGridMotion#N )
ZoneIterativeData_t {
  GridCoordinatesPointers = {"MovedGrid#1", "MovedGrid#2", ...,
                             "MovedGrid#N"}
  FlowSolutionPointers = {"Solution#1", "Solution#2, ..., "Solution#N"}
  ArbitraryGridMotionPointers = {"ArbitraryGridMotion#1",
                                 "ArbitraryGridMotion#2", ..., "ArbitraryGridMotion#N"}
}
}
```

Example 11-C: Adapted Unstructured Mesh

In this example, the mesh size varies at each remeshing, therefore new zones must be created. `ZonePointers` is used to keep a record of the zone definition corresponding to each recorded step. Let's assume that the solution is recorded every 50 iterations, and the grid is adapted every 100 iterations.

The number of steps, iteration values for each step, number of zones for each step, and name of these zones are recorded under `BaseIterativeData_t`.

```
CGNSBase_t {
  BaseIterativeData_t {
    NumberOfSteps = 4
    IterationValues = {50, 100, 150, 200}
    NumberOfZones = {1, 1, 1, 1}
    ZonePointers = {"Zone1", "Zone1", "Zone2", "Zone2"}
  }
}
```

Each zone holds 2 solutions recorded at 50 iterations apart. Therefore the `ZoneIterativeData_t` data structure must be included to keep track of the `FlowSolutionPointers`.

```
Zone_t Zone1 {
  --- Constant data
  GridCoordinates_t GridCoordinates
  Elements_t Elements
  ZoneBC_t ZoneBC

  --- Variable data
```

```

List ( FlowSolution_t InitialSolution Solution50 Solution100 )
ZoneIterativeData_t {
  FlowSolutionPointers = {"Solution50", "Solution100", "Null", "Null"}
}
}

Zone_t Zone2 {

  --- Constant data
  GridCoordinates_t GridCoordinates
  Elements_t Elements
  ZoneBC_t ZoneBC

  --- Variable data
  List ( FlowSolution_t RestartSolution Solution150 Solution200 )
  ZoneIterativeData_t {
    FlowSolutionPointers = {"Null", "Null", "Solution150", "Solution200"}
  }
}

```

Notes

1. If the solution was recorded every 100 iterations instead of every 50 iterations, then each zone would have only one `FlowSolution_t` node and the data structure `ZoneIterativeData_t` would not be required.
2. Note that `FlowSolutionPointers` is always an array of size `NumberOfSteps` even if some of the steps are defined in another zone.

Example 11-D: Combination of Grid Motion and Time-Accuracy

The following is an example demonstrating the use of the rigid grid motion, arbitrary grid motion, and time-accurate data nodes in CGNS. The example is a 3-zone case. Zone 1 is rigidly rotating about the x -axis at a constant rate, with no translation. Zone 2 is a deforming zone. Zone 3 is a fixed zone. This is a time-accurate simulation with two solutions saved at times 15.5 and 31.0, corresponding to iteration numbers 1000 and 2000.

No units are given in this example, but a real case would establish them. Also, a real case would include connectivity, boundary conditions, and possibly other information as well. Each indentation represents a level down (a child) from the parent node.

```

Base (CGNSBase_t)
  SimulationType (SimulationType_t) Data=TimeAccurate
  BaseIterativeData (BaseIterativeData_t) Data=NumberOfSteps=2
    TimeValues (DataArray_t) Data=(15.5, 31.0)
    IterationValues (DataArray_t) Data=(1000, 2000)
  Zone#1 (Zone_t)

```

```
GridCoordinates (GridCoordinates_t)
  CoordinateX (DataArray_t)
  CoordinateY (DataArray_t)
RigidGridMotion#1(RigidGridMotion_t) Data=RigidGridMotionType=ConstantRate
  OriginLocation (DataArray_t) Data=(0,0,0), (0,0,0)
  RigidRotationAngle (DataArray_t) Data=(5., 0., 0.)
RigidGridMotion#2(RigidGridMotion_t) Data=RigidGridMotionType=ConstantRate
  OriginLocation (DataArray_t) Data=(0,0,0), (0,0,0)
  RigidRotationAngle (DataArray_t) Data=(10., 0., 0.)
ZoneIterativeData (ZoneIterativeData_t)
  RigidGridMotionPointers (DataArray_t) Data=(RigidGridMotion#1,
                                             RigidGridMotion#2)
  FlowSolutionPointers (DataArray_t) Data=(Soln#1, Soln#2)
Soln#1 (FlowSolution_t)
  Density (DataArray_t)
  VelocityX (DataArray_t)
Soln#2 (FlowSolution_t)
  Density (DataArray_t)
  VelocityX (DataArray_t)
Zone#2 (Zone_t)
  GridCoordinates (GridCoordinates_t)
    CoordinateX (DataArray_t)
    CoordinateY (DataArray_t)
  MovedGrid#1 (GridCoordinates_t)
    CoordinateX (DataArray_t)
    CoordinateY (DataArray_t)
  MovedGrid#2 (GridCoordinates_t)
    CoordinateX (DataArray_t)
    CoordinateY (DataArray_t)
  ArbitraryGridMotion#1 (ArbitraryGridMotion_t)
    Data=ArbitraryGridMotionType=DeformingGrid
  ArbitraryGridMotion#2 (ArbitraryGridMotion_t)
    Data=ArbitraryGridMotionType=DeformingGrid
  GridVelocityX (DataArray_t)
  GridVelocityY (DataArray_t)
ZoneIterativeData (ZoneIterativeData_t)
  ArbitraryGridMotionPointers (DataArray_t) Data=("ArbitraryGridMotion#1",
                                                  "ArbitraryGridMotion#2")
  GridCoordinatesPointers (DataArray_t) Data=("MovedGrid#1",
                                              "MovedGrid#2")
  FlowSolutionPointers (DataArray_t) Data=("Soln#1", "Soln#2")
Soln#1 (FlowSolution_t)
  Density (DataArray_t)
  VelocityX (DataArray_t)
Soln#2 (FlowSolution_t)
```



```

    Density (DataArray_t)
    VelocityX (DataArray_t)
Zone#3 (Zone_t)
  GridCoordinates (GridCoordinates_t)
    CoordinateX (DataArray_t)
    CoordinateY (DataArray_t)
  ZoneIterativeData (ZoneIterativeData_t)
    FlowSolutionPointers (DataArray_t) Data=("Soln#1", "Soln#2")
  Soln#1 (FlowSolution_t)
    Density (DataArray_t)
    VelocityX (DataArray_t)
  Soln#2 (FlowSolution_t)
    Density (DataArray_t)
    VelocityX (DataArray_t)

```

Notes

1. Under `BaseIterativeData_t`, one can give either `TimeValues`, or `IterationValues`, or both. In the example, both have been given.
2. The nodes `NumberOfZones` and `ZonePointers` are not required under the `BaseIterativeData_t` node in this example because all existing zones are used for each time step.
3. Under `ArbitraryGridMotion`, the `GridVelocity` data is optional. In the example, it was put under one of the nodes but not under the other. Hence, "`ArbitraryGridMotion#1`" in the example has no children nodes, while "`ArbitraryGridMotion#2`" does.
4. The pointers under `ZoneIterativeData_t` point to names of nodes within the same zone. Thus, for example, `Soln#1` refers to the flow solution named `Soln#1` in the same zone, even though there are flow solution nodes in other zones with the same name.
5. The name `GridCoordinates` always refers to the *original* grid. Thus, when a grid is deforming, the deformed values must be put in `GridCoordinates_t` nodes of a different name. In the example, the deformed grids (for `Zone#2`) at the two times of interest were put into "`MovedGrid#1`" and "`MovedGrid#2`".
6. Because the node "`ArbitraryGridMotion#1`" doesn't really add any information in the current example (since it was decided not to store `GridVelocity` data under it), one has the option of not including this node in the CGNS file. If it is removed, then under `Zone#2`'s `ZoneIterativeData`, the `ArbitraryGridMotionPointers` data would be replaced by:

```
Data = (Null, ArbitraryGridMotion#2)
```

12 Miscellaneous Data Structures

This section contains miscellaneous structure types for describing reference states, convergence history, discrete field data, integral or global data, families, and user-defined data.

12.1 Reference State Structure Definition: ReferenceState_t

`ReferenceState_t` describes a reference state, which is a list of geometric or flow-state quantities defined at a common location or condition. Examples of typical reference states associated with CFD calculations are freestream, plenum, stagnation, inlet and exit. Note that providing a `ReferenceState` description is particularly important if items elsewhere in the CGNS database are `NormalizedByUnknownDimensional`.

```
ReferenceState_t :=
{
  Descriptor_t ReferenceStateDescription ;           (o)
  List( Descriptor_t Descriptor1 ... DescriptorN ) ; (o)

  List( DataArray_t<DataType, 1, 1> DataArray1 ... DataArrayN ) ; (o)

  DataClass_t DataClass ;                           (o)

  DimensionalUnits_t DimensionalUnits ;             (o)

  List( UserDefinedData_t UserDefinedData1 ... UserDefinedDataN ) ; (o)
} ;
```

Notes

1. Default names for the `Descriptor_t`, `DataArray_t`, and `UserDefinedData_t` lists are as shown; users may choose other legitimate names. Legitimate names must be unique within a given instance of `ReferenceState_t` and shall not include the names `DataClass`, `DimensionalUnits`, or `ReferenceStateDescription`.

Data-name identifiers associated with `ReferenceState` are shown in [Table 19](#).

In addition, any flowfield quantities (such as `Density`, `Pressure`, etc.) can be included in the `ReferenceState`.

The reference length L (`LengthReference`) may be necessary for `NormalizedByUnknownDimensional` databases, to define the length scale used for nondimensionalizations. It may be the same or different from the `Reynolds_Length` used to define the Reynolds number.

Because of different definitions for angle of attack and angle of yaw, these quantities are not explicitly defined in the SIDS. Instead, the user can unambiguously denote the freestream velocity

Table 19: Data-Name Identifiers for Reference State

Data-Name Identifier	Description	Units
Mach	Mach number, $M = q/c$	-
Mach_Velocity	Velocity scale, q	L/T
Mach_VelocitySound	Speed of sound scale, c	L/T
Reynolds	Reynolds number, $Re = VL_R/\nu$	-
Reynolds_Velocity	Velocity scale, V	L/T
Reynolds_Length	Length scale, L_R	L
Reynolds_ViscosityKinematic	Kinematic viscosity scale, ν	L ² /T
LengthReference	Reference length, L	L

vector direction by giving `VelocityX`, `VelocityY`, and `VelocityZ` in `ReferenceState`, (with the reference state denoting the freestream).

Care should be taken when defining the reference state quantities to ensure consistency. (See the discussion in [Section 5.2.3](#).) For example, if velocity, length, and time are all defined, then the velocity stored should be length/time. If consistency is not followed, different applications could interpret the resulting data in different ways.

`DataClass` defines the default for the class of data contained in the reference state. If any reference state quantities are dimensional, `DimensionalUnits` may be used to describe the system of dimensional units employed. If present, these two entities take precedence over all corresponding entities at higher levels of the hierarchy. These precedence rules are further discussed in [Section 6.4](#).

The `UserDefinedData_t` data structure allows arbitrary user-defined data to be stored in `Descriptor_t` and `DataArray_t` children without the restrictions or implicit meanings imposed on these node types at other node locations.

We recommend using the `ReferenceStateDescription` entity to document the flow conditions. The format of the documentation is currently unregulated.

12.2 Reference State Example

An example is presented in this section of a reference state entity that contains dimensional data. An additional example of a nondimensional reference state is provided in [Appendix B](#).

Example 12-A: Reference State with Dimensional Data

A freestream reference state where all data quantities are dimensional. Standard atmospheric conditions at sea level are assumed for static quantities, and all stagnation variables are obtained using the isentropic relations. The flow velocity is 200 m/s aligned with the x -axis. Dimensional units of kilograms, meters, and seconds are used. The data class and system of units are specified at the `ReferenceState_t` level rather than attaching this information directly to the `DataArray_t` entities for each reference quantity. Data-name identifiers are provided in [Appendix A](#).

```

ReferenceState_t ReferenceState =
  {{
  Descriptor_t ReferenceStateDescription =
    {{
      Data(char, 1, 45) = "Freestream at standard atmospheric conditions" ;
    }} ;

  DataClass_t DataClass = Dimensional ;

  DimensionalUnits_t DimensionalUnits =
    {{
      MassUnits          = Kilogram ;
      LengthUnits        = Meter ;
      TimeUnits           = Second ;
      TemperatureUnits   = Kelvin ;
      AngleUnits          = Radian ;
    }} ;

  DataArray_t<real, 1, 1> VelocityX =
    {{
      Data(real, 1, 1) = 200. ;
    }} ;
  DataArray_t<real, 1, 1> VelocityY      = {{ 0. }} ;
  DataArray_t<real, 1, 1> VelocityZ      = {{ 0. }} ;

  DataArray_t<real, 1, 1> Pressure        = {{ 1.0132E+05 }} ;
  DataArray_t<real, 1, 1> Density         = {{ 1.226 }} ;
  DataArray_t<real, 1, 1> Temperature    = {{ 288.15 }} ;
  DataArray_t<real, 1, 1> VelocitySound   = {{ 340. }} ;
  DataArray_t<real, 1, 1> ViscosityMolecular = {{ 1.780E-05 }} ;

  DataArray_t<real, 1, 1> PressureStagnation = {{ 1.2806E+05 }} ;
  DataArray_t<real, 1, 1> DensityStagnation = {{ 1.449 }} ;
  DataArray_t<real, 1, 1> TemperatureStagnation = {{ 308.09 }} ;
  DataArray_t<real, 1, 1> VelocitySoundStagnation = {{ 351.6 }} ;

  DataArray_t<real, 1, 1> PressureDynamic = {{ 0.2542E+05 }} ;
  }} ;

```

Note that all `DataArray_t` entities except `VelocityX` have been abbreviated.

12.3 Convergence History Structure Definition: `ConvergenceHistory_t`

Flow solver convergence history information is described by the `ConvergenceHistory_t` structure. This structure contains the number of iterations and a list of data arrays containing convergence

information at each iteration.

```
ConvergenceHistory_t :=
{
  Descriptor_t NormDefinitions ;                               (o)
  List( Descriptor_t Descriptor1 ... DescriptorN ) ;         (o)

  int Iterations ;                                           (r)

  List( DataArray_t<DataType, 1, Iterations>
        DataArray1 ... DataArrayN ) ;                       (o)

  DataClass_t DataClass ;                                    (o)

  DimensionalUnits_t DimensionalUnits ;                     (o)

  List( UserDefinedData_t UserDefinedData1 ... UserDefinedDataN ) ; (o)
} ;
```

Notes

1. Default names for the `Descriptor_t`, `DataArray_t`, and `UserDefinedData_t` lists are as shown; users may choose other legitimate names. Legitimate names must be unique within a given instance of `ConvergenceHistory_t` and shall not include the names `DataClass`, `DimensionalUnits`, or `NormDefinitions`.
2. `Iterations` is the only required field for `ConvergenceHistory_t`.

`Iterations` identifies the number of iterations for which convergence information is recorded. This value is also passed into each of the `DataArray_t` entities, defining the length of the data arrays.

`DataClass` defines the default for the class of data contained in the convergence history. If any convergence-history data is dimensional, `DimensionalUnits` may be used to describe the system of dimensional units employed. If present, these two entities take precedence over all corresponding entities at higher levels of the hierarchy. These precedence rules are further discussed in [Section 6.4](#).

The `UserDefinedData_t` data structure allows arbitrary user-defined data to be stored in `Descriptor_t` and `DataArray_t` children without the restrictions or implicit meanings imposed on these node types at other node locations.

Measures used to record convergence vary greatly among current flow-solver implementations. Convergence information typically includes global forces, norms of equation residuals, and norms of solution changes. Attempts to systematically define a set of convergence measures within the CGNS project have been futile. For global parameters, such as forces and moments, [Appendix A](#) lists a set of standardized data-array identifiers. For equations residuals and solution changes, no such standard list exists. It is suggested that data-array identifiers for norms of equations residuals begin with `RSD`, and those for solution changes begin with `CHG`. For example, `RSDMassRMS` could be used for the L_2 -norm (RMS) of mass conservation residuals. It is also strongly recommended that

`NormDefinitions` be utilized to describe the convergence information recorded in the data arrays. The format used to describe the convergence norms in `NormDefinitions` is currently unregulated.

12.4 Discrete Data Structure Definition: `DiscreteData_t`

`DiscreteData_t` provides a description of generic discrete data (i.e., data defined on a computational grid); it is identical to `FlowSolution_t` except for its type name. This structure can be used to store field data, such as fluxes or equation residuals, that is not typically considered part of the flow solution. `DiscreteData_t` contains a list for data arrays, identification of grid location, and a mechanism for identifying rind-point data included in the data arrays. All data contained within this structure must be defined at the same grid location and have the same amount of rind-point data.

```

DiscreteData_t< int CellDimension, int IndexDimension,
                int VertexSize[IndexDimension],
                int CellSize[IndexDimension] > :=
{
List( Descriptor_t Descriptor1 ... DescriptorN ) ;           (o)

GridLocation_t GridLocation ;                               (o/d)

Rind_t<IndexDimension> Rind ;                               (o/d)

IndexRange_t<IndexDimension> PointRange ;                 (o)
IndexArray_t<IndexDimension, ListLength[], int> PointList ; (o)

List( DataArray_t<DataType, IndexDimension, DataSize[]>
      DataArray1 ... DataArrayN ) ;                       (o)

DataClass_t DataClass ;                                    (o)

DimensionalUnits_t DimensionalUnits ;                     (o)

List( UserDefinedData_t UserDefinedData1 ... UserDefinedDataN ) ; (o)
} ;

```

Notes

1. Default names for the `Descriptor_t`, `DataArray_t`, and `UserDefinedData_t` lists are as shown; users may choose other legitimate names. Legitimate names must be unique within a given instance of `DiscreteData_t` and shall not include the names `DataClass`, `DimensionalUnits`, `GridLocation`, `PointRange`, `PointList`, or `Rind`.
2. There are no required fields for `DiscreteData_t`. `GridLocation` has a default of `Vertex` if absent. `Rind` also has a default if absent; the default is equivalent to having an instance of `Rind` whose `RindPlanes` array contains all zeros (see [Section 4.8](#)).

3. Both of the fields `PointRange` and `PointList` are optional. Only one of these two fields may be specified.
4. The structure parameter `DataType` must be consistent with the data stored in the `DataArray_t` entities (see [Section 5.1](#)).
5. For unstructured zones `GridLocation` options are limited to `Vertex` or `CellCenter`, unless one of `PointRange` or `PointList` is present.
6. Indexing of data within the `DataArray_t` structures, must be consistent with the associated numbering of vertices or elements.

`DiscreteData_t` requires four structure parameters: `CellDimension` identifies the dimensionality of cells or elements, `IndexDimension` identifies the dimensionality of the grid size arrays, and `VertexSize` and `CellSize` are the number of core vertices and cells, respectively, in each index direction. For unstructured zones, `IndexDimension` is always 1.

The arrays of discrete data are stored in the list of `DataArray_t` entities. The field `GridLocation` specifies the location of the data with respect to the grid; if absent, the data is assumed to coincide with grid vertices (i.e., `GridLocation = Vertex`). All data within a given instance of `DiscreteData_t` must reside at the same grid location.

For structured grids, the value of `GridLocation` alone specifies the location and indexing of the discrete data. Vertices are explicitly indexed. Cell centers and face centers are indexed using the minimum of the connecting vertex indices, as described in the section Structured Grid Notation and Indexing Conventions ([Section 3.2](#)).

For unstructured grids, the value of `GridLocation` alone specifies location and indexing of discrete data only for vertex and cell-centered data. The reason for this is that element-based grid connectivity provided in the `Elements_t` data structures explicitly indexes only vertices and cells. For data stored at alternate grid locations (e.g., edges), additional connectivity information is needed. This is provided by the optional fields `PointRange` and `PointList`; these refer to vertices, edges, faces or cell centers, depending on the values of `CellDimension` and `GridLocation`. [Table 20](#) shows these relations.

Table 20: GridLocation Usage with Discrete Data

CellDimension	GridLocation			
	Vertex	EdgeCenter	*FaceCenter	CellCenter
1	vertices	—	—	cells (line elements)
2	vertices	edges	—	cells (area elements)
3	vertices	edges	faces	cells (volume elements)

In the table, `*FaceCenter` stands for the possible types: `FaceCenter`, `IFaceCenter`, `JFaceCenter` or `KFaceCenter`.

Although intended for edge or face-based discrete data for unstructured grids, the fields `PointRange/List` may also be used to (redundantly) index vertex and cell-centered data. In all cases, indexing of discrete data corresponds to the element numbering as defined in the `Elements_t` data structures.

`Rind` is an optional field that indicates the number of rind planes (for structured grids) or rind points or elements (for unstructured grids) included in the data. Its purpose and function are identical to

those described in [Section 7.1](#). Note, however, that the `Rind` in this structure is independent of the `Rind` contained in `GridCoordinates_t`. They are not required to contain the same number of rind planes or elements. Also, the location of any flow-solution rind points is assumed to be consistent with the location of the core flow solution points (e.g., if `GridLocation = CellCenter`, rind points are assumed to be located at fictitious cell centers).

`DataClass` defines the default class for data contained in the `DataArray_t` entities. For dimensional data, `DimensionalUnits` may be used to describe the system of units employed. If present these two entities take precedence over the corresponding entities at higher levels of the CGNS hierarchy. The rules for determining precedence of entities of this type are discussed in [Section 6.4](#).

The `UserDefinedData_t` data structure allows arbitrary user-defined data to be stored in `Descriptor_t` and `DataArray_t` children without the restrictions or implicit meanings imposed on these node types at other node locations.

FUNCTION `ListLength[]`:

return value: `int`

dependencies: `PointRange`, `PointList`

`DiscreteData_t` requires the structure function `ListLength`, which is used to specify the number of entities (e.g. vertices) corresponding to a given `PointRange` or `PointList`. If `PointRange` is specified, then `ListLength` is obtained from the number of points (inclusive) between the beginning and ending indices of `PointRange`. If `PointList` is specified, then `ListLength` is the number of indices in the list of points. In this situation, `ListLength` becomes a user input along with the indices of the list `PointList`. By “user” we mean the application code that is generating the CGNS database.

FUNCTION `DataSize[]`:

return value: one-dimensional `int` array of length `IndexDimension`

dependencies: `IndexDimension`, `VertexSize[]`, `CellSize[]`, `GridLocation`, `Rind`, `ListLength`

The function `DataSize[]` is the size of discrete-data arrays. It is identical to the function `DataSize[]` defined for `FlowSolution_t` (see [Section 7.7](#)).

12.5 Integral Data Structure Definition: `IntegralData_t`

`IntegralData_t` provides a description of generic global or integral data that may be associated with a particular zone or an entire database. In contrast to `DiscreteData_t`, integral data is not associated with any specific field location.

```
IntegralData_t :=
{
  List( Descriptor_t Descriptor1 ... DescriptorN ) ;           (o)
```

```
List( dataArray_t<DataType, 1, 1> dataArray1 ... dataArrayN ) ;      (o)
DataClass_t DataClass ;                                           (o)
DimensionalUnits_t DimensionalUnits ;                             (o)
List( UserDefinedData_t UserDefinedData1 ... UserDefinedDataN ) ; (o)
} ;
```

Notes

1. Default names for the `Descriptor_t`, `DataArray_t`, and `UserDefinedData_t` lists are as shown; users may choose other legitimate names. Legitimate names must be unique within a given instance of `DiscreteData_t` and shall not include the names `DataClass` or `DimensionalUnits`.
2. There are no required fields for `IntegralData_t`.
3. The structure parameter `DataType` must be consistent with the data stored in the `DataArray_t` entities (see [Section 5.1](#)).

`DataClass` defines the default class for data contained in the `DataArray_t` entities. For dimensional data, `DimensionalUnits` may be used to describe the system of units employed. If present these two entities take precedence over the corresponding entities at higher levels of the CGNS hierarchy. The rules for determining precedence of entities of this type are discussed in [Section 6.4](#).

The `UserDefinedData_t` data structure allows arbitrary user-defined data to be stored in `Descriptor_t` and `DataArray_t` children without the restrictions or implicit meanings imposed on these node types at other node locations.

12.6 Family Data Structure Definition: `Family_t`

Geometric associations need to be set through one layer of indirection. That is, rather than setting the geometry data for each mesh entity (nodes, edges, and faces), they are associated to intermediate objects. The intermediate objects are in turn linked to nodal regions of the computational mesh. We define a CFD *family* as this intermediate object. This layer of indirection is necessary since there is rarely a 1-to-1 connection between mesh regions and geometric entities.

The `Family_t` data structure holds the CFD family data. Each mesh surface is linked to the geometric entities of the CAD databases by a name attribute. This attribute corresponds to a family of CAD geometric entities on which the mesh face is projected. Each one of these geometric entities is described in a CAD file and is not redefined within the CGNS file. A `Family_t` data structure may be included in the `CGNSBase_t` structure for each CFD family of the model.

The `Family_t` structure contains all information pertinent to a CFD family. This information includes the name attribute or family name, the boundary conditions applicable to these mesh regions, and the referencing to the CAD databases.

```

Family_t :=
{
  List( Descriptor_t Descriptor1 ... DescriptorN ) ;           (o)

  FamilyBC_t FamilyBC ;                                       (o)

  List( GeometryReference_t GeometryReference1 ... GeometryReferenceN ) ; (o)

  RotatingCoordinates_t RotatingCoordinates ;               (o)

  List( FamilyName_t FamilyName1 ... FamilyNameN ) ;         (o)

  List( UserDefinedData_t UserDefinedData1 ... UserDefinedDataN ) ; (o)

  int Ordinal ;                                             (o)
} ;

```

Notes

1. All data structures contained in `Family_t` are optional.
2. Default names for the `Descriptor_t`, `GeometryReference_t`, and `UserDefinedData_t` lists are as shown; users may choose other legitimate names. Legitimate names must be unique at this level and must not include the names `FamilyBC`, `Ordinal`, or `RotatingCoordinates`.
3. The CAD referencing data are written in the `GeometryReference_t` data structures. They identify the CAD systems and databases where the geometric definition of the family is stored.
4. The boundary condition type pertaining to a family is contained in the data structure `FamilyBC_t`. If this boundary condition type is to be used, the `BCType` specified under `BC_t` must be `FamilySpecified`.
5. For the purpose of defining zone properties, families are extended to a volume of cells. In such case, the `GeometryReference_t` structures are not used.
6. The mesh is linked to the family by attributing a family name to a BC patch or a zone in the data structure `BC_t` or `Zone_t`, respectively.
7. A hierarchy of families is possible through the list of `FamilyName_t` nodes. These nodes contain both a user defined node name and a family name. The node name `FamilyParent` may be used to specify the family name for the parent of the current `Family_t` node.
8. `Ordinal` is defined in the SIDS as a user-defined integer with no restrictions on the values that it can contain. It may be used here to attribute a number to the family.

Rotation of the CFD family may be defined using the `RotatingCoordinates_t` data structure.

The `UserDefinedData_t` data structure allows arbitrary user-defined data to be stored in `Descriptor_t` and `DataArray_t` children without the restrictions or implicit meanings imposed on these node types at other node locations.

12.7 Geometry Reference Structure Definition: GeometryReference_t

The standard interface data structure identifies the CAD systems used to generate the geometry, the CAD files where the geometry is stored, and the geometric entities corresponding to the family. The `GeometryReference_t` structures contain all the information necessary to associate a CFD family to the CAD databases. For each `GeometryReference_t` structure, the CAD format is recorded in `GeometryFormat`, and the CAD file in `GeometryFile`. The geometry entity or entities within this CAD file that correspond to the family are recorded under the `GeometryEntity_t` nodes.

```
GeometryReference_t :=
  {
    List( Descriptor_t Descriptor1 ... DescriptorN ) ;           (o)

    GeometryFormat_t GeometryFormat ;                          (r)

    GeometryFile_t GeometryFile ;                              (r)

    List (GeometryEntity_t GeometryEntity1 ... GeometryEntityN) ; (o/d)

    List( UserDefinedData_t UserDefinedData1 ... UserDefinedDataN ) ; (o)
  } ;
```

The `GeometryFormat` is an enumeration type that identifies the CAD system used to generate the geometry.

```
GeometryFormat_t := Enumeration(
  GeometryFormatNull,
  GeometryFormatUserDefined,
  NASA-IGES,
  SDRC,
  Unigraphics,
  ProEngineer,
  ICEM-CFD ) ;
```

Notes

1. Default names for the `Descriptor_t`, `GeometryEntity_t`, and `UserDefinedData_t` lists are as shown; users may choose other legitimate names. Legitimate names must be unique at this level and must not include the names `GeometryFile` or `GeometryFormat`.
2. By default, there is only one `GeometryEntity` and its name is the family name.
3. There is no limit to the number of CAD files or CAD systems referenced in a CGNS file. Different parts of the same model may be described with different CAD files of different CAD systems.
4. Other CAD geometry formats may be added to this list as needed.

12.8 Family Boundary Condition Structure Definition: FamilyBC_t

One of the main advantages of the concept of a layer of indirection (called a family here) is that the mesh density and the geometric entities may be modified without altering the association between nodes and intermediate objects, or between intermediate objects and geometric entities. This is very beneficial when handling boundary conditions and properties. Instead of setting boundary conditions directly on mesh entities, or on CAD entities, they may be associated to the intermediate objects. Since these intermediate objects are stable in the sense that they are not subject to mesh or geometric variations, the boundary conditions do not need to be redefined each time the model is modified. Using the concept of indirection, the boundary conditions and property settings are made independent of operations such as geometric changes, modification of mesh topology (i.e., splitting into zones), mesh refinement and coarsening, etc.

The `FamilyBC_t` data structure contains the boundary condition type. It is envisioned that it will be extended to hold both material and volume properties as well.

```
FamilyBC_t :=
{
  BCType_t BCType;                                     (r)

  List( FamilyBCDataSet_t<ListLength>; BCDataSet1 ... BCDataSetN ) ;   (o)
} ;
```

Notes

1. Default names for the `FamilyBCDataSet_t` list are as shown; users may choose other legitimate names. Legitimate names must be unique within a given instance of `FamilyBC_t` and shall not include the name `BCType`.

`BCType` specifies the boundary-condition type, which gives general information on the boundary-condition equations to be enforced. Boundary conditions are to be applied at the locations specified by the `BC_t` structure(s) associated with the CFD family.

The `FamilyBC_t` structure provides for a list of boundary-condition data sets. In general, the proper `FamilyBCDataSet_t` instance to impose on the CFD family is determined by the `BCType` association table (Table 9 on p. 159). The mechanics of determining the proper data set to impose is described in Section 9.8.

For a few boundary conditions, such as a symmetry plane or polar singularity, the value of `BCType` completely describes the equations to impose, and no instances of `FamilyBCDataSet_t` are needed. For “simple” boundary conditions, where a single set of Dirichlet and/or Neumann data is applied, a single `FamilyBCDataSet_t` will likely appear (although this is not a requirement). For “compound” boundary conditions, where the equations to impose are dependent on local flow conditions, several instances of `FamilyBCDataSet_t` will likely appear; the procedure for choosing the proper data set is more complex as described in Section 9.8.

12.9 Family Boundary Condition Data Set Structure Definition: FamilyBCDataSet_t

FamilyBCDataSet_t contains Dirichlet and Neumann data for a single set of boundary-condition equations. Its intended use is for simple boundary-condition types, where the equations imposed do not depend on local flow conditions.

```
FamilyBCDataSet_t :=
{
  List( Descriptor_t Descriptor1 ... DescriptorN ) ;           (o)

  BCTypeSimple_t BCTypeSimple ;                               (r)

  BCData_t<1> DirichletData ;                                  (o)
  BCData_t<1> NeumannData ;                                   (o)

  ReferenceState_t ReferenceState ;                           (o)

  DataClass_t DataClass ;                                     (o)

  DimensionalUnits_t DimensionalUnits ;                       (o)

  List( UserDefinedData_t UserDefinedData1 ... UserDefinedDataN ) ; (o)
} ;
```

Notes

1. Default names for the `Descriptor_t` and `UserDefinedData_t` lists are as shown; users may choose other legitimate names. Legitimate names must be unique within a given instance of `FamilyBCDataSet_t` and shall not include the names `BCTypeSimple`, `DataClass`, `DimensionalUnits`, `DirichletData`, `NeumannData` or `ReferenceState`.
2. `BCTypeSimple` is the only required field. All other fields are optional and the `Descriptor_t` list may be empty.

`BCTypeSimple` specifies the boundary-condition type, which gives general information on the boundary-condition equations to be enforced. `BCTypeSimple_t` is defined in [Section 9.7](#) along with the meanings of all the `BCTypeSimple` values. `BCTypeSimple` is also used for matching boundary condition data sets as discussed in [Section 9.8](#).

Boundary-condition data is separated by equation type into Dirichlet and Neumann conditions. Dirichlet boundary conditions impose the value of the given variables, whereas Neumann boundary conditions impose the normal derivative of the given variables. The mechanics of specifying Dirichlet and Neumann data for boundary conditions is covered in [Section 9.9](#).

The substructures `DirichletData` and `NeumannData` contain boundary-condition data defined as globally constant over the family.

Reference quantities applicable to the set of boundary-condition data are contained in the `ReferenceState` structure. `DataClass` defines the default for the class of data contained in the boundary-condition data. If the boundary conditions contain dimensional data, `DimensionalUnits` may be used to describe the system of dimensional units employed. If present, these three entities take precedence over all corresponding entities at higher levels of the hierarchy. These precedence rules are further discussed in [Section 6.4](#).

The `UserDefinedData_t` data structure allows arbitrary user-defined data to be stored in `Descriptor_t` and `DataArray_t` children without the restrictions or implicit meanings imposed on these node types at other node locations.

Note that `FamilyBCDataSet_t` is similar to the data structure `BCDataSet_t` ([Section 9.4](#)). The primary difference is that `FamilyBCDataSet_t` only allows for globally constant Dirichlet and Neumann data.

12.10 User-Defined Data Structure Definition: `UserDefinedData_t`

Since the needs of all CGNS users cannot be anticipated, `UserDefinedData_t` provides a means of storing arbitrary user-defined data in `Descriptor_t` and `DataArray_t` children without the restrictions or implicit meanings imposed on these node types at other node locations.

```

UserDefinedData_t :=
{
  List( Descriptor_t Descriptor1 ... DescriptorN ) ;           (o)

  GridLocation_t GridLocation ;                               (o/d)

  IndexRange_t<IndexDimension> PointRange ;                 (o)
  IndexArray_t<IndexDimension, ListLength, int> PointList ; (o)

  List( DataArray_t<> DataArray1 ... DataArrayN ) ;         (o)

  DataClass_t DataClass ;                                    (o)

  DimensionalUnits_t DimensionalUnits ;                     (o)

  FamilyName_t FamilyName ;                                  (o)

  List( AdditionalFamilyName_t AddFamilyName1 ... AddFamilyNameN ) ; (o)

  List( UserDefinedData_t UserDefinedData1 ... UserDefinedDataN ) ; (o)

  int Ordinal ;                                             (o)
} ;

```

Notes

1. Default names for the `Descriptor_t`, `DataArray_t`, and `UserDefinedData_t` lists are as shown; users may choose other legitimate names. Legitimate names must be unique within a given instance of `UserDefinedData_t` and shall not include the names `DataClass`, `DimensionalUnits`, `FamilyName`, `GridLocation`, `Ordinal`, `PointList`, or `PointRange`.
2. `GridLocation` may be set to `Vertex`, `IFaceCenter`, `JFaceCenter`, `KFaceCenter`, `FaceCenter`, `CellCenter`, or `EdgeCenter`. If `GridLocation` is absent, then its default value is `Vertex`. When `GridLocation` is set to `Vertex`, then `PointList` or `PointRange` refer to node indices, for both structured and unstructured grids. When `GridLocation` is set to `FaceCenter`, then `PointList` or `PointRange` refer to face elements.
3. `GridLocation`, `PointRange`, and `PointList` may only be used when `UserDefinedData_t` is located below a `Zone_t` structure in the database hierarchy.
4. Only one of `PointRange` and `PointList` may be specified.
5. Both `FamilyName` and `AdditionalFamilyName` should refer to a `CGNSBase_t` level `Family_t`, in the parent base or in another sibling base (see [Section 6.2.1](#)).

12.11 Gravity Data Structure Definition: `Gravity_t`

The `Gravity_t` data structure may be used to define the gravitational vector.

```
Gravity_t :=  
  {  
    List( Descriptor_t Descriptor1 ... DescriptorN ) ;           (o)  
  
    DataArray_t<real, 1, PhysicalDimension> GravityVector ;    (r)  
  
    DataClass_t DataClass ;                                     (o)  
  
    DimensionalUnits_t DimensionalUnits ;                     (o)  
  
    List( UserDefinedData_t UserDefinedData1 ... UserDefinedDataN ) ; (o)  
  } ;
```

Notes

1. Default names for the `Descriptor_t` and `UserDefinedData_t` lists are as shown; users may choose other legitimate names. Legitimate names must be unique within a given instance of `Gravity_t` and shall not include the names `DataClass`, `DimensionalUnits`, or `GravityVector`.

The only required field under the `Gravity_t` data structure is `GravityVector`, which contains the components of the gravity vector in the coordinate system being used.

`DataClass` defines the default class for data contained in the `DataArray_t` entity. For dimensional data, `DimensionalUnits` may be used to describe the system of units employed. If present, these

two entities take precedence over the corresponding entities at higher levels of the CGNS hierarchy, following the standard precedence rules.

The `UserDefinedData_t` data structure allows arbitrary user-defined data to be stored in `Descriptor_t` and `DataArray_t` children without the restrictions or implicit meanings imposed on these node types at other node locations.

13 Bibliography

Poirier, D. M. A., Allmaras, S. R., McCarthy, D. R., Smith, M. F., Enomoto, F. Y., "The CGNS System," AIAA-98-3007, June 1998.

Poirier, D. M. A., Bush, R. H., Cosner, R. R., Rumsey, C. L., McCarthy, D. R., "Advances in the CGNS Database Standard for Aerodynamics and CFD," AIAA-2000-0681, January 2000.

Legensky, S. M., Edwards, D. E., Bush, R. H., Poirier, D. M. A., Rumsey, C. L., Cosner, R. R., Towne, C. E., "CFD General Notation System (CGNS): Status and Future Directions," AIAA-2002-0752, January 2002.

Hauser, T., "Parallel I/O for the CGNS System," AIAA-2004-1088, January 2004.

Poinot, M., Rumsey, C. L., Mani, M., "Impact of CGNS on CFD Workflow," AIAA-2004-2142, June-July 2004.

Iepan, H., Guibault, F., Vallet, M.-G., Magnan, R., "CGNS-Based Data Model for Turbine Blade Optimization," AIAA-2005-0334, January 2005.

Poinot, M., Montreuil, E., Henaux, E., "Checking CFD Interfaces in a Multi-Disciplinary Workflow with an XML/CGNS Compiler," AIAA-2005-1155, January 2005.

Pakalapati, P. D., Hauser, T., "Benchmarking Parallel I/O Performance for Computational Fluid Dynamics Applications," AIAA-2005-1381, January 2005.

Hauser, T., "Benchmarking the CGNS I/O Performance," AIAA-2008-0479, January 2008.

Rumsey, C. L., Wedan, B., Hauser, T., Poinot, M., "Recent Updates to the CFD General Notation System (CGNS)," AIAA-2012-1264, January 2012.

Appendix A Conventions for Data-Name Identifiers

Identifiers or names can be attached to `DataArray_t` entities to identify and describe the quantity being stored. To facilitate communication between different application codes, we propose to establish a set of standardized data-name identifiers with fairly precise definitions. For any identifier in this set, the associated data should be unambiguously understood. In essence, this section proposes standardized terminology for labeling CFD-related data, including grid coordinates, flow solution, turbulence model quantities, nondimensional governing parameters, boundary condition quantities, and forces and moments.

We use the convention that all standardized identifiers denote scalar quantities; this is consistent with the intended use of the `DataArray_t` structure type to describe an array of scalars. For quantities that are vectors, such as velocity, their components are listed.

Included with the lists of standard data-name identifiers are the fundamental units of dimensions associated with that quantity. The following notation is used for the fundamental units: **M** is mass, **L** is length, **T** is time, **Θ** is temperature, **α** is angle, and **I** is electric current. These fundamental units are directly associated with the elements of the `DimensionalExponents_t` structure. For example, a quantity that has dimensions **ML/T** corresponds to `MassExponent = +1`, `LengthExponent = +1`, and `TimeExponent = -1`.

Unless otherwise noted, all quantities in the following sections denote floating-point data types, and the appropriate `DataType` structure parameter for `DataArray_t` is `real`.

A.1 Coordinate Systems

Coordinate systems for identifying physical location are shown in [Table A.1](#).

Table A.1: Coordinate Systems

System	3-D	2-D
Cartesian	(x, y, z)	(x, y) or (x, z) or (y, z)
Cylindrical	(r, θ, z)	(r, θ)
Spherical	(r, θ, ϕ)	
Auxiliary	(ξ, η, ζ)	(ξ, η) or (ξ, ζ) or (η, ζ)

Associated with these coordinate systems are the following unit vector conventions:

x -direction	\hat{e}_x	r -direction	\hat{e}_r	ξ -direction	\hat{e}_ξ
y -direction	\hat{e}_y	θ -direction	\hat{e}_θ	η -direction	\hat{e}_η
z -direction	\hat{e}_z	ϕ -direction	\hat{e}_ϕ	ζ -direction	\hat{e}_ζ

Note that \hat{e}_r , \hat{e}_θ and \hat{e}_ϕ are functions of position.

We envision that one of the “standard” coordinate systems (Cartesian, cylindrical or spherical) will be used within a zone (or perhaps the entire database) to define grid coordinates and other related

data. The auxiliary coordinates will be used for special quantities, including forces and moments, which may not be defined in the same coordinate system as the rest of the data. When auxiliary coordinates are used, a transformation must also be provided to uniquely define them. For example, the transform from Cartesian to orthogonal auxiliary coordinates is,

$$\begin{pmatrix} \hat{e}_\xi \\ \hat{e}_\eta \\ \hat{e}_\zeta \end{pmatrix} = \mathbf{T} \begin{pmatrix} \hat{e}_x \\ \hat{e}_y \\ \hat{e}_z \end{pmatrix},$$

where \mathbf{T} is an orthonormal matrix (2×2 in 2-D and 3×3 in 3-D).

In addition, normal and tangential coordinates are often used to define boundary conditions and data related to surfaces. The normal coordinate is identified as n with the unit vector \hat{e}_n .

The data-name identifiers defined for coordinate systems are listed in [Table A.2](#). All represent real `DataTypes`, except for `ElementConnectivity` and `ParentData`, which are integer.

Table A.2: Data-Name Identifiers for Coordinate Systems

Data-Name Identifier	Description	Units
<code>CoordinateX</code>	x	L
<code>CoordinateY</code>	y	L
<code>CoordinateZ</code>	z	L
<code>CoordinateR</code>	r	L
<code>CoordinateTheta</code>	θ	α
<code>CoordinatePhi</code>	ϕ	α
<code>CoordinateNormal</code>	Coordinate in direction of \hat{e}_n	L
<code>CoordinateTangential</code>	Tangential coordinate (2-D only)	L
<code>CoordinateXi</code>	ξ	L
<code>CoordinateEta</code>	η	L
<code>CoordinateZeta</code>	ζ	L
<code>CoordinateTransform</code>	Transformation matrix (\mathbf{T})	-
<code>InterpolantsDonor</code>	Interpolation factors	-
<code>ElementConnectivity</code>	Nodes making up an element	-
<code>ParentData</code>	Element parent identification	-

A.2 Flowfield Solution

This section describes data-name identifiers for typical Navier-Stokes solution variables. The list is obviously incomplete, but should suffice for initial implementation of the CGNS system. The

variables listed in this section are dimensional or raw quantities; nondimensional parameters and coefficients based on these variables are discussed in [Section A.4](#).

We use fairly universal notation for state variables. Static quantities are measured with the fluid at speed: static density (ρ), static pressure (p), static temperature (T), static internal energy per unit mass (e), static enthalpy per unit mass (h), entropy (s), and static speed of sound (c). We also approximate the true entropy by the function $\tilde{s} = p/\rho^\gamma$ (this assumes an ideal gas). The velocity is $\vec{q} = u\hat{e}_x + v\hat{e}_y + w\hat{e}_z$, with magnitude $q = \sqrt{\vec{q}\cdot\vec{q}}$. Stagnation quantities are obtained by bringing the fluid isentropically to rest; these are identified by a subscript “0”. The term “total” is also used to refer to stagnation quantities.

Conservation variables are density, momentum ($\rho\vec{q} = \rho u\hat{e}_x + \rho v\hat{e}_y + \rho w\hat{e}_z$), and stagnation energy per unit volume (ρe_0).

For rotating coordinate systems, u , v , and w are the x , y , and z components of the velocity vector in the inertial frame; $\vec{\omega}$ is the rotation rate vector; \vec{R} is a vector from the center of rotation to the point of interest; and $\vec{w}_r = \vec{\omega} \times \vec{R}$ is the rotational velocity vector of the rotating frame of reference, with components w_{rx} , w_{ry} , and w_{rz} .

Molecular diffusion and heat transfer introduce the molecular viscosity (μ), kinematic viscosity (ν) and thermal conductivity coefficient (k). These are obtained from the state variables through auxiliary correlations. For a perfect gas, μ and k are functions of static temperature only.

The Navier-Stokes equations involve the strain tensor ($\bar{\bar{S}}$) and the shear-stress tensor ($\bar{\bar{\tau}}$). Using indicial notation, the 3-D Cartesian components of the strain tensor are,

$$\bar{\bar{S}}_{i,j} = \left(\frac{\partial u_i}{\partial x_j} + \frac{\partial u_j}{\partial x_i} \right),$$

and the stress tensor is,

$$\bar{\bar{\tau}}_{i,j} = \mu \left(\frac{\partial u_i}{\partial x_j} + \frac{\partial u_j}{\partial x_i} \right) + \lambda \frac{\partial u_k}{\partial x_k},$$

where $(x_1, x_2, x_3) = (x, y, z)$ and $(u_1, u_2, u_3) = (u, v, w)$. The bulk viscosity is usually approximated as $\lambda = -2/3\mu$.

Reynolds averaging of the Navier-Stokes equations introduce Reynolds stresses ($-\rho\overline{u'v'}$, etc.) and turbulent heat flux terms ($-\rho\overline{u'e'}$, etc.), where primed quantities are instantaneous fluctuations and the bar is an averaging operator. These quantities are obtained from auxiliary turbulence closure models. Reynolds-stress models formulate transport equations for the Reynolds stresses directly; whereas, eddy-viscosity models correlate the Reynolds stresses with the mean strain rate,

$$-\overline{u'v'} = \nu_t \left(\frac{\partial u}{\partial y} + \frac{\partial v}{\partial x} \right),$$

where ν_t is the kinematic eddy viscosity. The eddy viscosity is either correlated to mean flow quantities by algebraic models or by auxiliary transport models. An example two-equation turbulence transport model is the k - ϵ model, where transport equations are formulated for the turbulent kinetic energy ($k = \frac{1}{2}(\overline{u'u'} + \overline{v'v'} + \overline{w'w'})$) and turbulent dissipation (ϵ).

Skin friction evaluated at a surface is the dot product of the shear stress tensor with the surface normal:

$$\vec{\tau} = \bar{\bar{\tau}} \cdot \hat{n},$$

Note that skin friction is a vector.

The data-name identifiers defined for flow solution quantities are listed in [Table A.3](#).

Note that for some vector quantities, like momentum, the table only explicitly lists data-name identifiers for the x , y , and z components, and for the magnitude. It should be understood, however, that for any vector quantity with a standardized data name “**Vector**”, the following standardized data names are also defined:

VectorX	x -component of vector
VectorY	y -component of vector
VectorZ	z -component of vector
VectorR	Radial component of vector
VectorTheta	θ -component of vector
VectorPhi	ϕ -component of vector
VectorMagnitude	Magnitude of vector
VectorNormal	Normal component of vector
VectorTangential	Tangential component of vector (2-D only)

Also note that some data-name identifiers used with multi-species flows include the variable string *Symbol*, which represents either the chemical symbol for a species, or a defined name for a mixture. See [Section 10.9](#) for examples, and [Table 15](#) on p. 187 for a list of defined names.

Table A.3: Data-Name Identifiers for Flow Solution Quantities

Data-Name Identifier	Description	Units
Potential	Potential: $\nabla\phi = \vec{q}$	\mathbf{L}^2/\mathbf{T}
StreamFunction	Stream function (2-D): $\nabla \times \psi = \vec{q}$	\mathbf{L}^2/\mathbf{T}
Density	Static density (ρ)	\mathbf{M}/\mathbf{L}^3
Pressure	Static pressure (p)	$\mathbf{M}/(\mathbf{L}\mathbf{T}^2)$
Temperature	Static temperature (T)	Θ
EnergyInternal	Static internal energy per unit mass (e)	$\mathbf{L}^2/\mathbf{T}^2$
Enthalpy	Static enthalpy per unit mass (h)	$\mathbf{L}^2/\mathbf{T}^2$
Entropy	Entropy (s)	$\mathbf{M}\mathbf{L}^2/(\mathbf{T}^2\Theta)$
EntropyApprox	Approximate entropy ($\tilde{s} = p/\rho^\gamma$)	$\mathbf{L}^{3\gamma-1}/(\mathbf{M}^{\gamma-1}\mathbf{T}^2)$
DensityStagnation	Stagnation density (ρ_0)	\mathbf{M}/\mathbf{L}^3
PressureStagnation	Stagnation pressure (p_0)	$\mathbf{M}/(\mathbf{L}\mathbf{T}^2)$
TemperatureStagnation	Stagnation temperature (T_0)	Θ
EnergyStagnation	Stagnation energy per unit mass (e_0)	$\mathbf{L}^2/\mathbf{T}^2$

Continued on next page

Table A.3: Data-Name Identifiers for Flow Solution Quantities (*Continued*)

Data-Name Identifier	Description	Units
EnthalpyStagnation	Stagnation enthalpy per unit mass (h_0)	$\mathbf{L}^2/\mathbf{T}^2$
EnergyStagnationDensity	Stagnation energy per unit volume (ρe_0)	$\mathbf{M}/(\mathbf{L}\mathbf{T}^2)$
VelocityX	x -component of velocity ($u = \vec{q} \cdot \hat{e}_x$)	\mathbf{L}/\mathbf{T}
VelocityY	y -component of velocity ($v = \vec{q} \cdot \hat{e}_y$)	\mathbf{L}/\mathbf{T}
VelocityZ	z -component of velocity ($w = \vec{q} \cdot \hat{e}_z$)	\mathbf{L}/\mathbf{T}
VelocityR	Radial velocity component ($\vec{q} \cdot \hat{e}_r$)	\mathbf{L}/\mathbf{T}
VelocityTheta	Velocity component in θ direction ($\vec{q} \cdot \hat{e}_\theta$)	\mathbf{L}/\mathbf{T}
VelocityPhi	Velocity component in ϕ direction ($\vec{q} \cdot \hat{e}_\phi$)	\mathbf{L}/\mathbf{T}
VelocityMagnitude	Velocity magnitude ($q = \sqrt{\vec{q} \cdot \vec{q}}$)	\mathbf{L}/\mathbf{T}
VelocityNormal	Normal velocity component ($\vec{q} \cdot \hat{n}$)	\mathbf{L}/\mathbf{T}
VelocityTangential	Tangential velocity component (2-D)	\mathbf{L}/\mathbf{T}
VelocitySound	Static speed of sound	\mathbf{L}/\mathbf{T}
VelocitySoundStagnation	Stagnation speed of sound	\mathbf{L}/\mathbf{T}
MomentumX	x -component of momentum (ρu)	$\mathbf{M}/(\mathbf{L}^2\mathbf{T})$
MomentumY	y -component of momentum (ρv)	$\mathbf{M}/(\mathbf{L}^2\mathbf{T})$
MomentumZ	z -component of momentum (ρw)	$\mathbf{M}/(\mathbf{L}^2\mathbf{T})$
MomentumMagnitude	Magnitude of momentum (ρq)	$\mathbf{M}/(\mathbf{L}^2\mathbf{T})$
RotatingVelocityX	x -component of velocity, relative to rotating frame ($u_{rx} = u - w_{rx}$)	\mathbf{L}/\mathbf{T}
RotatingVelocityY	y -component of velocity, relative to rotating frame ($u_{ry} = v - w_{ry}$)	\mathbf{L}/\mathbf{T}
RotatingVelocityZ	z -component of velocity, relative to rotating frame ($u_{rz} = w - w_{rz}$)	\mathbf{L}/\mathbf{T}
RotatingMomentumX	x -component of momentum, relative to rotating frame (ρu_{rx})	$\mathbf{M}/(\mathbf{L}^2\mathbf{T})$
RotatingMomentumY	y -component of momentum, relative to rotating frame (ρu_{ry})	$\mathbf{M}/(\mathbf{L}^2\mathbf{T})$
RotatingMomentumZ	z -component of momentum, relative to rotating frame (ρu_{rz})	$\mathbf{M}/(\mathbf{L}^2\mathbf{T})$
RotatingVelocityMagnitude	Velocity magnitude in rotating frame ($q_r = \sqrt{u_{rx}^2 + u_{ry}^2 + u_{rz}^2}$)	\mathbf{L}/\mathbf{T}

Continued on next page

Table A.3: Data-Name Identifiers for Flow Solution Quantities (*Continued*)

Data-Name Identifier	Description	Units
RotatingPressureStagnation	Stagnation pressure in rotating frame	$\mathbf{M}/(\mathbf{LT}^2)$
RotatingEnergyStagnation	Stagnation energy per unit mass in rotating frame $((e_0)_r)$	$\mathbf{L}^2/\mathbf{T}^2$
RotatingEnergyStagnationDensity	Stagnation energy per unit volume in rotating frame $(\rho(e_0)_r)$	$\mathbf{M}/(\mathbf{LT}^2)$
RotatingEnthalpyStagnation	Stagnation enthalpy per unit mass in rotating frame, rothalpy	$\mathbf{L}^2/\mathbf{T}^2$
EnergyKinetic	$(u^2 + v^2 + w^2)/2 = q^2/2$	$\mathbf{L}^2/\mathbf{T}^2$
PressureDynamic	$\rho q^2/2$	$\mathbf{M}/(\mathbf{LT}^2)$
SoundIntensityDB	Sound intensity level in decibels, $10 \log_{10}(I/I_{\text{ref}}) = 20 \log_{10}(p/p_{\text{ref}})$, where I is the sound power per unit area, $I_{\text{ref}} = 10^{-12}$ watts/m ² is the reference sound power per unit area, p is the pressure wave amplitude, and $p_{\text{ref}} = 2 \times 10^{-5}$ N/m ² is the reference pressure.	-
SoundIntensity	Sound intensity (i.e., sound power per unit area, I)	\mathbf{M}/\mathbf{T}^3
VorticityX	$\omega_x = \partial w/\partial y - \partial v/\partial z = \vec{\omega} \cdot \hat{e}_x$	\mathbf{T}^{-1}
VorticityY	$\omega_y = \partial u/\partial z - \partial w/\partial x = \vec{\omega} \cdot \hat{e}_y$	\mathbf{T}^{-1}
VorticityZ	$\omega_z = \partial v/\partial x - \partial u/\partial y = \vec{\omega} \cdot \hat{e}_z$	\mathbf{T}^{-1}
VorticityMagnitude	$\omega = \sqrt{\vec{\omega} \cdot \vec{\omega}}$	\mathbf{T}^{-1}
SkinFrictionX	x -component of skin friction $(\vec{\tau} \cdot \hat{e}_x)$	$\mathbf{M}/(\mathbf{LT}^2)$
SkinFrictionY	y -component of skin friction $(\vec{\tau} \cdot \hat{e}_y)$	$\mathbf{M}/(\mathbf{LT}^2)$
SkinFrictionZ	z -component of skin friction $(\vec{\tau} \cdot \hat{e}_z)$	$\mathbf{M}/(\mathbf{LT}^2)$
SkinFrictionMagnitude	Skin friction magnitude $(\sqrt{\vec{\tau} \cdot \vec{\tau}})$	$\mathbf{M}/(\mathbf{LT}^2)$
VelocityAngleX	Velocity angle $(\arccos(u/q) \in [0, 180^\circ])$	α
VelocityAngleY	$\arccos(v/q)$	α
VelocityAngleZ	$\arccos(w/q)$	α
VelocityUnitVectorX	x -component of velocity unit vector $(\vec{q} \cdot \hat{e}_x/q)$	-

Continued on next page

Table A.3: Data-Name Identifiers for Flow Solution Quantities (*Continued*)

Data-Name Identifier	Description	Units
VelocityUnitVectorY	y -component of velocity unit vector ($\vec{q} \cdot \hat{e}_y / q$)	-
VelocityUnitVectorZ	z -component of velocity unit vector ($\vec{q} \cdot \hat{e}_z / q$)	-
MassFlow	Mass flow normal to a plane ($\rho \vec{q} \cdot \hat{n}$)	$\mathbf{M}/(\mathbf{L}^2\mathbf{T})$
ViscosityKinematic	Kinematic viscosity ($\nu = \mu/\rho$)	\mathbf{L}^2/\mathbf{T}
ViscosityMolecular	Molecular viscosity (μ)	$\mathbf{M}/(\mathbf{LT})$
ViscosityEddyKinematic	Kinematic eddy viscosity (ν_t)	\mathbf{L}^2/\mathbf{T}
ViscosityEddy	Eddy viscosity (μ_t)	$\mathbf{M}/(\mathbf{LT})$
ThermalConductivity	Thermal conductivity coefficient (k)	$\mathbf{ML}/(\mathbf{T}^3\Theta)$
PowerLawExponent	Power-law exponent (n) in molecular viscosity or thermal conductivity model	-
SutherlandLawConstant	Sutherland's Law constant (T_s) in molecular viscosity or thermal conductivity model	Θ
TemperatureReference	Reference temperature (T_{ref}) in molecular viscosity or thermal conductivity model	Θ
ViscosityMolecularReference	Reference viscosity (μ_{ref}) in molecular viscosity model	$\mathbf{M}/(\mathbf{LT})$
ThermalConductivityReference	Reference thermal conductivity (k_{ref}) in thermal conductivity model	$\mathbf{ML}/(\mathbf{T}^3\Theta)$
IdealGasConstant	Ideal gas constant ($R = c_p - c_v$)	$\mathbf{L}^2/(\mathbf{T}^2\Theta)$
SpecificHeatPressure	Specific heat at constant pressure (c_p)	$\mathbf{L}^2/(\mathbf{T}^2\Theta)$
SpecificHeatVolume	Specific heat at constant volume (c_v)	$\mathbf{L}^2/(\mathbf{T}^2\Theta)$
ReynoldsStressXX	Reynolds stress $-\overline{\rho u' u'}$	$\mathbf{M}/(\mathbf{LT}^2)$
ReynoldsStressXY	Reynolds stress $-\overline{\rho u' v'}$	$\mathbf{M}/(\mathbf{LT}^2)$
ReynoldsStressXZ	Reynolds stress $-\overline{\rho u' w'}$	$\mathbf{M}/(\mathbf{LT}^2)$
ReynoldsStressYY	Reynolds stress $-\overline{\rho v' v'}$	$\mathbf{M}/(\mathbf{LT}^2)$
ReynoldsStressYZ	Reynolds stress $-\overline{\rho v' w'}$	$\mathbf{M}/(\mathbf{LT}^2)$
ReynoldsStressZZ	Reynolds stress $-\overline{\rho w' w'}$	$\mathbf{M}/(\mathbf{LT}^2)$

Continued on next page

Table A.3: Data-Name Identifiers for Flow Solution Quantities (*Continued*)

Data-Name Identifier	Description	Units
MolecularWeight $Symbol$	Molecular weight for species $Symbol$	-
HeatOfFormation $Symbol$	Heat of formation per unit mass for species $Symbol$	L^2/T^2
FuelAirRatio	Fuel/air mass ratio	-
ReferenceTemperatureHOF	Reference temperature for the heat of formation	Θ
MassFraction $Symbol$	Mass of species $Symbol$, divided by total mass	-
LaminarViscosity $Symbol$	Laminar viscosity of species $Symbol$	$M/(LT)$
ThermalConductivity $Symbol$	Thermal conductivity of species $Symbol$	$ML/(T^3\Theta)$
EnthalpyEnergyRatio	The ratio $\beta = h/e = \int_{T_{ref}}^T c_p dT / \int_{T_{ref}}^T c_v dT$	-
CompressibilityFactor	The gas constant of the mixture divided by the freestream gas constant, $Z = R/R_\infty$	-
VibrationalElectronEnergy	Vibrational-electronic excitation energy per unit mass	L^2/T^2
HeatOfFormation	Heat of formation per unit mass for the entire mixture, $H = \sum_{i=1}^n Y_i H_i$, where n is the number of species, Y_i is the mass fraction of species i , and H_i is the heat of formation for species i at the reference temperature ReferenceTemperatureHOF. This requires that ReferenceTemperatureHOF be specified using the ChemicalKineticsModel data structure.	L^2/T^2
VibrationalElectronTemperature	Vibrational electron temperature	Θ
SpeciesDensity $Symbol$	Density of species $Symbol$	M/L^3
MoleFraction $Symbol$	Number of moles of species $Symbol$ divided by the total number of moles for all species	-
Voltage	Voltage	ML^2/TI
ElectricFieldX	x -component of electric field vector	ML/TI
ElectricFieldY	y -component of electric field vector	ML/TI

Continued on next page

Table A.3: Data-Name Identifiers for Flow Solution Quantities (*Continued*)

Data-Name Identifier	Description	Units
ElectricFieldZ	z -component of electric field vector	$\mathbf{ML}/\mathbf{T}\mathbf{I}$
MagneticFieldX	x -component of magnetic field vector	\mathbf{I}/\mathbf{L}
MagneticFieldY	y -component of magnetic field vector	\mathbf{I}/\mathbf{L}
MagneticFieldZ	z -component of magnetic field vector	\mathbf{I}/\mathbf{L}
CurrentDensityX	x -component of current density vector	\mathbf{I}/\mathbf{L}^2
CurrentDensityY	y -component of current density vector	\mathbf{I}/\mathbf{L}^2
CurrentDensityZ	z -component of current density vector	\mathbf{I}/\mathbf{L}^2
ElectricConductivity	Electrical conductivity	$\mathbf{ML}/\mathbf{T}^3\mathbf{I}^2$
LorentzForceX	x -component of Lorentz force vector	\mathbf{ML}/\mathbf{T}^2
LorentzForceY	y -component of Lorentz force vector	\mathbf{ML}/\mathbf{T}^2
LorentzForceZ	z -component of Lorentz force vector	\mathbf{ML}/\mathbf{T}^2
JouleHeating	Joule heating	$\mathbf{ML}^2/\mathbf{T}^2$
LengthReference	Reference length L	\mathbf{L}

A.3 Turbulence Model Solution

This section lists data-name identifiers for typical Reynolds-averaged Navier-Stokes turbulence model variables. Turbulence model solution quantities and model constants present a particularly difficult nomenclature problem—to be precise we need to identify both the variable and the model (and version) that it comes from. The list in Table A.4 falls short in this respect.

Table A.4: Data-Name Identifiers for Typical Turbulence Models

Data-Name Identifier	Description	Units
TurbulentDistance	Distance to nearest wall	L
TurbulentEnergyKinetic	$k = \frac{1}{2}(\overline{u'u'} + \overline{v'v'} + \overline{w'w'})$	L²/T²
TurbulentDissipation	ϵ	L²/T³
TurbulentDissipationRate	$\epsilon/k = \omega$	T⁻¹
TurbulentBBReynolds	Baldwin-Barth one-equation model R_T	-
TurbulentSANuTilde	Spalart-Allmaras one-equation model $\tilde{\nu}$	L²/T

A.4 Nondimensional Parameters

CFD codes are rich in nondimensional governing parameters, such as Mach number and Reynolds number, and nondimensional flowfield coefficients, such as pressure coefficient. The problem with these parameters is that the definitions and conditions at which they are evaluated can vary from code to code. Reynolds number is particularly notorious in this respect.

These parameters have posed a difficult dilemma for us. Either we impose a rigid definition for each and force all database users to abide by it, or we develop some methodology for describing the particular definition that the user is employing. The first limits applicability and flexibility, and the second adds complexity. We have opted for the second approach, but we include only enough information about the definition of each parameter to allow for conversion operations. For example, the Reynolds number includes velocity, length, and kinematic viscosity scales in its definition (i.e., $Re = VL_R/\nu$). The database description of Reynolds number includes these different scales. By providing these “definition components”, any code that reads Reynolds number from the database can transform its value to an appropriate internal definition. These definition components are identified by appending a “_” to the data-name identifier of the parameter.

Definitions for nondimensional flowfield coefficients follow: the pressure coefficient is defined as,

$$c_p = \frac{p - p_{\text{ref}}}{\frac{1}{2}\rho_{\text{ref}}q_{\text{ref}}^2},$$

where $\frac{1}{2}\rho_{\text{ref}}q_{\text{ref}}^2$ is the dynamic pressure evaluated at some reference condition, and p_{ref} is some

reference pressure. The skin friction coefficient is,

$$\vec{c}_f = \frac{\vec{\tau}}{\frac{1}{2}\rho_{\text{ref}}q_{\text{ref}}^2},$$

where $\vec{\tau}$ is the shear stress or skin friction vector. Usually, $\vec{\tau}$ is evaluated at the wall surface.

The data-name identifiers defined for nondimensional governing parameters and flowfield coefficients are listed in Table A.5.

Table A.5: Data-Name Identifiers for Nondimensional Parameters

Data-Name Identifier	Description	Units
Mach	Mach number: $M = q/c$	-
Mach_Velocity	Velocity scale (q)	L/T
Mach_VelocitySound	Speed of sound scale (c)	L/T
RotatingMach	Mach number relative to rotating frame: $M_r = q_r/c$	-
Reynolds	Reynolds number: $Re = VL_R/\nu$	-
Reynolds_Velocity	Velocity scale (V)	L/T
Reynolds_Length	Length scale (L_R)	L
Reynolds_ViscosityKinematic	Kinematic viscosity scale (ν)	L²/T
Prandtl	Prandtl number: $Pr = \mu c_p/k$	-
Prandtl_ThermalConductivity	Thermal conductivity scale (k)	ML/(T³Θ)
Prandtl_ViscosityMolecular	Molecular viscosity scale (μ)	M/(LT)
Prandtl_SpecificHeatPressure	Specific heat scale (c_p)	L²/(T²Θ)
PrandtlTurbulent	Turbulent Prandtl number, $\rho\nu_t c_p/k_t$	-
SpecificHeatRatio	Specific heat ratio: $\gamma = c_p/c_v$	-
SpecificHeatRatio_Pressure	Specific heat at constant pressure (c_p)	L²/(T²Θ)
SpecificHeatRatio_Volume	Specific heat at constant volume (c_v)	L²/(T²Θ)
CoefPressure	c_p	-
CoefSkinFrictionX	$\vec{c}_f \cdot \hat{e}_x$	-
CoefSkinFrictionY	$\vec{c}_f \cdot \hat{e}_y$	-
CoefSkinFrictionZ	$\vec{c}_f \cdot \hat{e}_z$	-
Coef_PressureDynamic	$\rho_{\text{ref}}q_{\text{ref}}^2/2$	M/(LT²)
Coef_PressureReference	p_{ref}	M/(LT²)

A.5 Characteristics and Riemann Invariants Based on 1-D Flow

Boundary condition specification for inflow/outflow or farfield boundaries often involves Riemann invariants or characteristics of the linearized inviscid flow equations. For an ideal compressible gas, these are typically defined as follows: Riemann invariants for an isentropic 1-D flow are,

$$\left[\frac{\partial}{\partial t} + (u \pm c) \frac{\partial}{\partial x} \right] \left(u \pm \frac{2}{\gamma - 1} c \right) = 0.$$

Characteristic variables for the 3-D Euler equations linearized about a constant mean flow are,

$$\left[\frac{\partial}{\partial t} + \bar{\Lambda}_n \frac{\partial}{\partial x} \right] W'_n(x, t) = 0, \quad n = 1, 2, \dots, 5,$$

where the characteristics and corresponding characteristic variables are shown in [Table A.6](#). Barred

Table A.6: Characteristic Variables

Characteristic	$\bar{\Lambda}_n$	W'_n
Entropy	\bar{u}	$p' - \rho' / \bar{c}^2$
Vorticity	\bar{u}	v'
Vorticity	\bar{u}	w'
Acoustic	$\bar{u} \pm \bar{c}$	$p' \pm u' / (\bar{\rho} \bar{c})$

quantities are evaluated at the mean flow, and primed quantities are linearized perturbations. The only non-zero mean-flow velocity component is \bar{u} . The data-name identifiers defined for Riemann invariants and characteristic variables are listed in [Table A.7](#).

Table A.7: Data-Name Identifiers for Characteristics and Riemann Invariants

Data-Name Identifier	Description	Units
RiemannInvariantPlus	$u + 2c/(\gamma - 1)$	L/T
RiemannInvariantMinus	$u - 2c/(\gamma - 1)$	L/T
CharacteristicEntropy	$p' - \rho' / \bar{c}^2$	M/(LT²)
CharacteristicVorticity1	v'	L/T
CharacteristicVorticity2	w'	L/T
CharacteristicAcousticPlus	$p' + u' / (\bar{\rho} \bar{c})$	M/(LT²)
CharacteristicAcousticMinus	$p' - u' / (\bar{\rho} \bar{c})$	M/(LT²)

A.6 Forces and Moments

Conventions for data-name identifiers for forces and moments are defined in this section. Ideally, forces and moments should be attached to geometric components or less ideally to surface grids.

Currently, the standard mechanism for storing forces and moments is generally through the `ConvergenceHistory_t` node described in [Section 12.3](#), either attached to the entire configuration (under `CGNSBase_t`, [Section 6.2](#)) or attached to a zone (under `Zone_t`, [Section 6.3](#)).

Given a differential force \vec{f} (i.e., a force per unit area), the force integrated over a surface is,

$$\vec{F} = F_x \hat{e}_x + F_y \hat{e}_y + F_z \hat{e}_z = \int \vec{f} dA,$$

where \hat{e}_x , \hat{e}_y and \hat{e}_z are the unit vectors in the x , y and z directions, respectively. The moment about a point \vec{r}_0 integrated over a surface is,

$$\vec{M} = M_x \hat{e}_x + M_y \hat{e}_y + M_z \hat{e}_z = \int (\vec{r} - \vec{r}_0) \times \vec{f} dA.$$

Lift and drag components of the integrated force are,

$$L = \vec{F} \cdot \hat{L} \quad D = \vec{F} \cdot \hat{D}$$

where \hat{L} and \hat{D} are the unit vectors in the positive lift and drag directions, respectively.

Lift, drag and moment are often computed in auxiliary coordinate frames (e.g., wind axes or stability axes). We introduce the convention that lift, drag and moment are computed in the (ξ, η, ζ) coordinate system. Positive drag is assumed parallel to the ξ -direction (i.e., $\hat{D} = \hat{e}_\xi$); and positive lift is assumed parallel to the η -direction (i.e., $\hat{L} = \hat{e}_\eta$). Thus, forces and moments defined in this auxiliary coordinate system are,

$$L = \vec{F} \cdot \hat{e}_\eta \quad D = \vec{F} \cdot \hat{e}_\xi$$

$$\vec{M} = M_\xi \hat{e}_\xi + M_\eta \hat{e}_\eta + M_\zeta \hat{e}_\zeta = \int (\vec{r} - \vec{r}_0) \times \vec{f} dA.$$

Lift, drag and moment coefficients in 3-D are defined as,

$$C_L = \frac{L}{\frac{1}{2} \rho_{\text{ref}} q_{\text{ref}}^2 S_{\text{ref}}} \quad C_D = \frac{D}{\frac{1}{2} \rho_{\text{ref}} q_{\text{ref}}^2 S_{\text{ref}}} \quad \vec{C}_M = \frac{\vec{M}}{\frac{1}{2} \rho_{\text{ref}} q_{\text{ref}}^2 c_{\text{ref}} S_{\text{ref}}},$$

where $\frac{1}{2} \rho_{\text{ref}} q_{\text{ref}}^2$ is a reference dynamic pressure, S_{ref} is a reference area, and c_{ref} is a reference length. For a wing, S_{ref} is typically the wing area and c_{ref} is the mean aerodynamic chord. In 2-D, the sectional force coefficients are,

$$c_l = \frac{L'}{\frac{1}{2} \rho_{\text{ref}} q_{\text{ref}}^2 c_{\text{ref}}} \quad c_d = \frac{D'}{\frac{1}{2} \rho_{\text{ref}} q_{\text{ref}}^2 c_{\text{ref}}} \quad \vec{c}_m = \frac{\vec{M}'}{\frac{1}{2} \rho_{\text{ref}} q_{\text{ref}}^2 c_{\text{ref}}^2},$$

where the forces are integrated along a contour (e.g., an airfoil cross-section) rather than a surface.

The data-name identifiers and definitions provided for forces and moments and their associated coefficients are listed in [Table A.8](#). For coefficients, the dynamic pressure and length scales used in the normalization are provided.

Table A.8: Data-Name Identifiers for Forces and Moments

Data-Name Identifier	Description	Units
ForceX	$F_x = \vec{F} \cdot \hat{e}_x$	ML/T ²
ForceY	$F_y = \vec{F} \cdot \hat{e}_y$	ML/T ²
ForceZ	$F_z = \vec{F} \cdot \hat{e}_z$	ML/T ²
ForceR	$F_r = \vec{F} \cdot \hat{e}_r$	ML/T ²
ForceTheta	$F_\theta = \vec{F} \cdot \hat{e}_\theta$	ML/T ²
ForcePhi	$F_\phi = \vec{F} \cdot \hat{e}_\phi$	ML/T ²
Lift	L or L'	ML/T ²
Drag	D or D'	ML/T ²
MomentX	$M_x = \vec{M} \cdot \hat{e}_x$	ML ² /T ²
MomentY	$M_y = \vec{M} \cdot \hat{e}_y$	ML ² /T ²
MomentZ	$M_z = \vec{M} \cdot \hat{e}_z$	ML ² /T ²
MomentR	$M_r = \vec{M} \cdot \hat{e}_r$	ML ² /T ²
MomentTheta	$M_\theta = \vec{M} \cdot \hat{e}_\theta$	ML ² /T ²
MomentPhi	$M_\phi = \vec{M} \cdot \hat{e}_\phi$	ML ² /T ²
MomentXi	$M_\xi = \vec{M} \cdot \hat{e}_\xi$	ML ² /T ²
MomentEta	$M_\eta = \vec{M} \cdot \hat{e}_\eta$	ML ² /T ²
MomentZeta	$M_\zeta = \vec{M} \cdot \hat{e}_\zeta$	ML ² /T ²
Moment_CenterX	$x_0 = \vec{r}_0 \cdot \hat{e}_x$	L
Moment_CenterY	$y_0 = \vec{r}_0 \cdot \hat{e}_y$	L
Moment_CenterZ	$z_0 = \vec{r}_0 \cdot \hat{e}_z$	L
CoefLift	C_L or c_l	-
CoefDrag	C_D or c_d	-
CoefMomentX	$\vec{C}_M \cdot \hat{e}_x$ or $\vec{c}_m \cdot \hat{e}_x$	-
CoefMomentY	$\vec{C}_M \cdot \hat{e}_y$ or $\vec{c}_m \cdot \hat{e}_y$	-
CoefMomentZ	$\vec{C}_M \cdot \hat{e}_z$ or $\vec{c}_m \cdot \hat{e}_z$	-
CoefMomentR	$\vec{C}_M \cdot \hat{e}_r$ or $\vec{c}_m \cdot \hat{e}_r$	-
CoefMomentTheta	$\vec{C}_M \cdot \hat{e}_\theta$ or $\vec{c}_m \cdot \hat{e}_\theta$	-
CoefMomentPhi	$\vec{C}_M \cdot \hat{e}_\phi$ or $\vec{c}_m \cdot \hat{e}_\phi$	-
CoefMomentXi	$\vec{C}_M \cdot \hat{e}_\xi$ or $\vec{c}_m \cdot \hat{e}_\xi$	-
CoefMomentEta	$\vec{C}_M \cdot \hat{e}_\eta$ or $\vec{c}_m \cdot \hat{e}_\eta$	-
CoefMomentZeta	$\vec{C}_M \cdot \hat{e}_\zeta$ or $\vec{c}_m \cdot \hat{e}_\zeta$	-
Coef_PressureDynamic	$1/2\rho_{\text{ref}}q_{\text{ref}}^2$	M/(LT ²)
Coef_Area	S_{ref}	L ²
Coef_Length	c_{ref}	L

A.7 Time-Dependent Flow

Data-name identifiers related to time-dependent flow include those associated with the storage of grid coordinates and flow solutions as a function of time level or iteration (see Table A.9). Also included are identifiers for storing information defining both rigid and arbitrary (i.e., deforming) grid motion.

Table A.9: Data-Name Identifiers for Time-Dependent Flow

Data-Name Identifier	Data Type	Description	Units
TimeValues	real	Time values	T
IterationValues	int	Iteration values	-
NumberOfZones	int	Number of zones used for each recorded step	-
NumberOfFamilies	int	Number of families used for each recorded step	-
ZonePointers	char	Names of zones used for each recorded step	-
FamilyPointers	char	Names of families used for each recorded step	-
RigidGridMotionPointers	char	Names of <code>RigidGridMotion</code> structures used for each recorded step for a zone	-
ArbitraryGridMotionPointers	char	Names of <code>ArbitraryGridMotion</code> structures used for each recorded step for a zone	-
GridCoordinatesPointers	char	Names of <code>GridCoordinates</code> structures used for each recorded step for a zone	-
FlowSolutionPointers	char	Names of <code>FlowSolution</code> structures used for each recorded step for a zone	-
OriginLocation	real	Physical coordinates of the origin before and after a rigid grid motion	L
RigidRotationAngle	real	Rotation angles about each axis of the translated coordinate system for rigid grid motion	α
RigidVelocity	real	Grid velocity vector of the origin translation for rigid grid motion	L/T
RigidRotationRate	real	Rotation rate vector about the axis of the translated coordinate system for rigid grid motion	α/T
GridVelocityX	real	x -component of grid velocity	L/T
GridVelocityY	real	y -component of grid velocity	L/T

Continued on next page

Table A.9: Data-Name Identifiers for Time-Dependent Flow (*Continued*)

Data-Name Identifier	Data Type	Description	Units
GridVelocityZ	real	z -component of grid velocity	L/T
GridVelocityR	real	r -component of grid velocity	L/T
GridVelocityTheta	real	θ -component of grid velocity	α/\mathbf{T}
GridVelocityPhi	real	ϕ -component of grid velocity	α/\mathbf{T}
GridVelocityXi	real	ξ -component of grid velocity	L/T
GridVelocityEta	real	η -component of grid velocity	L/T
GridVelocityZeta	real	ζ -component of grid velocity	L/T

Appendix B Structured Two-Zone Flat Plate Example

This section describes a complete database for a sample test case. The test case is compressible turbulent flow past a flat plate at zero incidence. The domain is divided into two zones as shown in [Figure B.1](#). The interface between the two zones is 1-to-1.

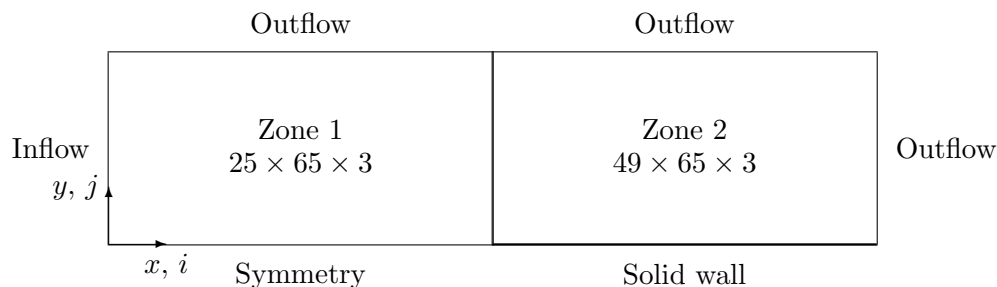

Figure B.1: Two-Zone Flat Plate Test Case

The database description includes the following:

- range of indices within each zone
- grid coordinates of vertices
- flowfield solution at cell centers including a row of ghost-cells along each boundary; the flowfield includes the conservation variables and a turbulent transport variable
- multizone interface connectivity information
- boundary condition information
- reference state
- description of the compressible Navier-Stokes equations including one-equation turbulence model

Each of these items is described in separate sections to make the information more readable. The same database is presented in each section, but only that information needed for the particular focus is included. The overall layout of the database is presented in [Section B.1](#).

All data for this test case is nondimensional and is normalized consistently by the following (dimensional) quantities: plate length L , freestream static density ρ_∞ , freestream static speed of sound c_∞ , and freestream static temperature T_∞ . The fact that the database is completely nondimensional is reflected in the value of the globally set data class.

B.1 Overall Layout

This section describes the overall layout of the database. Included are the cell dimension and physical dimension of the grid, the globally set data class, the global reference state and flow-equations description, and data pertaining to each zone. Each zone contains the grid size, grid

coordinates, flow solution, multizone interfaces and boundary conditions. All entities given by `{{*}}` are expanded in subsequent sections. Note that because this example contains structured zones, `IndexDimension = CellDimension = 3` in each zone.

```
CGNSBase_t TwoZoneCase =
  {{
  int CellDimension = 3 ;
  int PhysicalDimension = 3 ;

  DataClass_t DataClass = NormalizedByUnknownDimensional ;

  ReferenceState_t ReferenceState = {{*}} ;

  FlowEquationSet_t<3> FlowEquationSet = {{*}} ;

  ! CellDimension = 3, PhysicalDimension = 3
  Zone_t<3,3> Zone1 =
    {{
    int VertexSize = [25,65,3] ;
    int CellSize   = [24,64,2] ;
    int VertexSizeBoundary = [0,0,0];

    ZoneType_t ZoneType = Structured;

    ! IndexDimension = 3
    GridCoordinates_t<3,VertexSize> GridCoordinates = {{*}} ;

    FlowSolution_t<3,VertexSize,CellSize> FlowSolution = {{*}} ;

    ZoneGridConnectivity_t<3,3> ZoneGridConnectivity = {{*}} ;

    ZoneBC_t<3,3> ZoneBC = {{*}} ;
    }} ;          ! end Zone1

  ! CellDimension = 3, PhysicalDimension = 3
  Zone_t<3,3> Zone2 =
    {{
    int VertexSize = [49,65,3] ;
    int CellSize   = [48,64,2] ;
    int VertexSizeBoundary = [0,0,0];

    ZoneType_t ZoneType = Structured;

    ! IndexDimension = 3
    GridCoordinates_t<3,VertexSize> GridCoordinates = {{*}} ;
```

```

FlowSolution_t<3,VertexSize,CellSize> FlowSolution = {{*}} ;

ZoneGridConnectivity_t<3,3> ZoneGridConnectivity = {{*}} ;

ZoneBC_t<3,3> ZoneBC = {{*}} ;
}} ;          ! end Zone2
}} ;          ! end TwoZoneCase

```

B.2 Grid Coordinates

This section describes the grid-coordinate entities for each zone. Since the coordinates are all nondimensional, the individual `DataArray_t` entities do not include a data-class qualifier; instead, this information is derived from the globally set data class. The grid-coordinate entities for zone 2 are abbreviated.

```

CGNSBase_t TwoZoneCase =
  {{
  int CellDimension = 3 ;
  int PhysicalDimension = 3 ;

  DataClass_t DataClass = NormalizedByUnknownDimensional ;

  ! CellDimension = 3, PhysicalDimension = 3
  Zone_t<3,3> Zone1 =
    {{
    int VertexSize = [25,65,3] ;
    int CellSize   = [24,64,2] ;
    int VertexSizeBoundary = [0,0,0];

    ZoneType_t ZoneType = Structured;

    ! IndexDimension = 3
    ! VertexSize = [25,65,3]
    GridCoordinates_t<3, [25,65,3]> GridCoordinates =
      {{
      DataArray_t<real, 3, [25,65,3]> CoordinateX =
        {{
          Data(real, 3, [25,65,3]) = ((x(i,j,k), i=1,25), j=1,65), k=1,3) ;
        }} ;

      DataArray_t<real, 3, [25,65,3]> CoordinateY =
        {{
          Data(real, 3, [25,65,3]) = ((y(i,j,k), i=1,25), j=1,65), k=1,3) ;
        }} ;

```

```
DataArray_t<real, 3, [25,65,3]> CoordinateZ =
  {{
    Data(real, 3, [25,65,3]) = ((z(i,j,k), i=1,25), j=1,65), k=1,3) ;
  }} ;
}} ;      ! end Zone1/GridCoordinates
}} ;      ! end Zone1

! CellDimension = 3, PhysicalDimension = 3
Zone_t<3,3> Zone2 =
  {{
    int VertexSize = [49,65,3] ;
    int CellSize   = [48,64,2] ;
    int VertexSizeBoundary = [0,0,0];

    ZoneType_t ZoneType = Structured;

    ! IndexDimension = 3
    ! VertexSize = [49,65,3]
    GridCoordinates_t<3, [49,65,3]> GridCoordinates =
      {{
        DataArray_t<real, 3, [49,65,3]> CoordinateX = {{*}} ;
        DataArray_t<real, 3, [49,65,3]> CoordinateY = {{*}} ;
        DataArray_t<real, 3, [49,65,3]> CoordinateZ = {{*}} ;
      }} ;      ! end Zone2/GridCoordinates
    }} ;      ! end Zone2
  }} ;      ! end TwoZoneCase
```

B.3 Flowfield Solution

This section provides a description of the flowfield solution including the conservation variables and the Spalart-Allmaras turbulent-transport quantity ($\tilde{\nu}$). The flowfield solution is given at cell centers with a single row of ghost-cell values along each boundary.

As with the case for grid coordinates, the flow solution is nondimensional, and this fact is derived from the globally set data class. The normalizations for each flow variable are,

$$\rho'_{ijk} = \frac{\rho_{ijk}}{\rho_{\infty}}, \quad (\rho u)'_{ijk} = \frac{(\rho u)_{ijk}}{\rho_{\infty} c_{\infty}}, \quad (\rho e_0)'_{ijk} = \frac{(\rho e_0)_{ijk}}{\rho_{\infty} c_{\infty}^2}, \quad \tilde{\nu}'_{ijk} = \frac{\tilde{\nu}_{ijk}}{c_{\infty} L},$$

where primed quantities are nondimensional and all others are dimensional.

Only the `Density` entity for zone 1 is fully described in the following. The momentum, energy and turbulence solution are abbreviated. The entire flow-solution data for zone 2 is also abbreviated.

```
CGNSBase_t TwoZoneCase =
  {{
```



```

int CellDimension = 3 ;
int PhysicalDimension = 3 ;

DataClass_t DataClass = NormalizedByUnknownDimensional ;

! CellDimension = 3, PhysicalDimension = 3
Zone_t<3,3> Zone1 =
  {{
  int VertexSize = [25,65,3] ;
  int CellSize   = [24,64,2] ;
  int VertexSizeBoundary = [0,0,0];

  ZoneType_t ZoneType = Structured;

  ! IndexDimension = 3
  ! VertexSize = [25,65,3]
  ! CellSize   = [24,64,2]
  FlowSolution_t<3, [25,65,3], [24,64,2]> FlowSolution =
    {{
    GridLocation_t GridLocation = CellCenter ;

    ! IndexDimension = 3
    Rind_t<3> Rind =
      {{
      int[6] RindPlanes = [1,1,1,1,1,1] ;
      }} ;

    ! IndexDimension = 3
    ! DataSize = CellSize + [2,2,2] = [26,66,4]
    DataArray_t<real, 3, [26,66,4]> Density =
      {{
      Data(real, 3, [26,66,4]) = (((rho(i,j,k), i=0,25), j=0,65), k=0,3) ;
      }} ;

    DataArray_t<real, 3, [26,66,4]> MomentumX = {{*}} ;
    DataArray_t<real, 3, [26,66,4]> MomentumY = {{*}} ;
    DataArray_t<real, 3, [26,66,4]> MomentumZ = {{*}} ;
    DataArray_t<real, 3, [26,66,4]> EnergyStagnationDensity = {{*}} ;
    DataArray_t<real, 3, [26,66,4]> TurbulentSANutilde = {{*}} ;
    }} ;      ! end Zone1/FlowSolution
  }} ;      ! end Zone1

Zone_t<3,3> Zone2 = {{*}} ;
}} ;      ! end TwoZoneCase

```

B.4 Interface Connectivity

This section describes the interface connectivity between zones 1 and 2; it also includes the k -plane periodicity for each zone (which is essentially an interface connectivity of a zone onto itself). Each interface entity is repeated with the receiver and donor-zone roles reversed; this includes the periodic k -plane interfaces. Since each interface is a complete zone face, the `GridConnectivity1to1_t` entities are named after the face.

Because of the orientation of the zones, the index transformation matrices (`Transform`) for all interfaces are diagonal. This means that each matrix is its own inverse, and the value of `Transform` is the same for every pair of interface entities.

```
CGNSBase_t TwoZoneCase =
  {{
  int CellDimension = 3 ;
  int PhysicalDimension = 3 ;

  ! ----- ZONE 1 Interfaces -----

  ! CellDimension = 3, PhysicalDimension = 3
  Zone_t<3,3> Zone1 =
    {{
    int VertexSize = [25,65,3] ;
    int CellSize   = [24,64,2] ;
    int VertexSizeBoundary = [0,0,0];

    ZoneType_t ZoneType = Structured;

    ! IndexDimension = 3, CellDimension = 3
    ZoneGridConnectivity_t<3,3> ZoneGridConnectivity =
      {{

      ! IndexDimension = 3
      GridConnectivity1to1_t<3> IMax =                ! ZONE 1 IMax
      {{
      int[3] Transform = [1,2,3] ;
      IndexRange_t<3> PointRange =
        {{
        int[3] Begin = [25,1 ,1] ;
        int[3] End   = [25,65,3] ;
        }} ;
      IndexRange_t<3> PointRangeDonor =
        {{
        int[3] Begin = [1,1 ,1] ;
        int[3] End   = [1,65,3] ;
```

```

    }} ;
    Identifier(Zone_t) ZoneDonorName = Zone2 ;
}} ;

GridConnectivity1to1_t<3> KMin =                ! ZONE 1 KMin
  {{
  int[3] Transform = [1,2,-3] ;
  IndexRange_t<3> PointRange =
    {{
    int[3] Begin = [1 ,1 ,1] ;
    int[3] End   = [25,65,1] ;
    }} ;
  IndexRange_t<3> PointRangeDonor =
    {{
    int[3] Begin = [1 ,1 ,3] ;
    int[3] End   = [25,65,3] ;
    }} ;
  Identifier(Zone_t) ZoneDonorName = Zone1 ;
}} ;

GridConnectivity1to1_t<3> KMax =                ! ZONE 1 KMax
  {{
  int[3] Transform = [1,2,-3] ;
  IndexRange_t<3> PointRange =
    {{
    int[3] Begin = [1 ,1 ,3] ;
    int[3] End   = [25,65,3] ;
    }} ;
  IndexRange_t<3> PointRangeDonor =
    {{
    int[3] Begin = [1 ,1 ,1] ;
    int[3] End   = [25,65,1] ;
    }} ;
  Identifier(Zone_t) ZoneDonorName = Zone1 ;
}} ;
}} ;      ! end Zone1/ZoneGridConnectivity
}} ;      ! end Zone1

! ----- ZONE 2 Interfaces -----

! CellDimension = 3, PhysicalDimension = 3
Zone_t<3,3> Zone2 =
  {{
  int VertexSize = [49,65,3] ;

```

```
int CellSize    = [48,64,2] ;
int VertexSizeBoundary = [0,0,0];

ZoneType_t ZoneType = Structured;

! IndexDimension = 3, CellDimension = 3
ZoneGridConnectivity_t<3,3> ZoneGridConnectivity =
  {{

! IndexDimension = 3
GridConnectivity1to1_t<3> IMin =                ! ZONE 2 IMin
  {{
  int[3] Transform = [1,2,3] ;
  IndexRange_t<3> PointRange =
    {{
      int[3] Begin = [1,1 ,1] ;
      int[3] End   = [1,65,3] ;
    }} ;
  IndexRange_t<3> PointRangeDonor =
    {{
      int[3] Begin = [25,1 ,1] ;
      int[3] End   = [25,65,3] ;
    }} ;
  Identifier(Zone_t) ZoneDonorName = Zone1 ;
  }} ;

GridConnectivity1to1_t<3> KMin =                ! ZONE 2 KMin
  {{
  int[3] Transform = [1,2,-3] ;
  IndexRange_t<3> PointRange =
    {{
      int[3] Begin = [1 ,1 ,1] ;
      int[3] End   = [49,65,1] ;
    }} ;
  IndexRange_t<3> PointRangeDonor =
    {{
      int[3] Begin = [1 ,1 ,3] ;
      int[3] End   = [49,65,3] ;
    }} ;
  Identifier(Zone_t) ZoneDonorName = Zone2 ;
  }} ;

GridConnectivity1to1_t<3> KMax =                ! ZONE 2 KMax
  {{
  int[3] Transform = [1,2,-3] ;
```

```

IndexRange_t<3> PointRange =
  {{
    int[3] Begin = [1 ,1 ,3] ;
    int[3] End   = [49,65,3] ;
  }} ;
IndexRange_t<3> PointRangeDonor =
  {{
    int[3] Begin = [1 ,1 ,1] ;
    int[3] End   = [49,65,1] ;
  }} ;
Identifier(Zone_t) ZoneDonorName = Zone2 ;
}} ;
}} ;      ! end Zone2/ZoneGridConnectivity
}} ;      ! end Zone2
}} ;      ! end TwoZoneCase

```

B.5 Boundary Conditions

Boundary conditions for the flat plate case are described in this section. The minimal information necessary is included in each boundary condition; this includes the boundary-condition type and BC-patch specification. The lone exception is the viscous wall, which is isothermal and has an imposed temperature profile (given by the array `temperatureprofile()`). For all other boundary conditions a flow solver is free to impose appropriate BC-data since none is provided in the following. The imposed BC-data for all cases should be evaluated at the globally set reference state, since no other reference states have been specified.

No boundary condition descriptions are provided for the multizone interface or for the k -plane periodicity in each zone. All relevant information is provided for these interfaces in the `GridConnectivity1to1_t` entities of the previous section.

The practice of naming `BC_t` entities after the face is followed.

```

CGNSBase_t TwoZoneCase =
  {{
    int CellDimension = 3 ;
    int PhysicalDimension = 3 ;

    DataClass_t DataClass = NormalizedByUnknownDimensional ;

    ! ----- ZONE 1 BC's -----

    ! CellDimension = 3, PhysicalDimension = 3
    Zone_t<3,3> Zone1 =
      {{
        int VertexSize = [25,65,3] ;
        int CellSize   = [24,64,2] ;
      }}

```

```
int VertexSizeBoundary = [0,0,0];

ZoneType_t ZoneType = Structured;

! IndexDimension = 3, PhysicalDimension = 3
ZoneBC_t<3,3> ZoneBC =
  {{

! IndexDimension = 3, PhysicalDimension = 3
BC_t<3,3> IMin = ! ZONE 1 IMin
  {{
  BCType_t BCType = BCInflowSubsonic ;
  IndexRange_t<3> PointRange =
    {{
      int[3] Begin = [1,1 ,1] ;
      int[3] End   = [1,65,3] ;
    }} ;
  }} ;

BC_t<3,3> JMin = ! ZONE 1 JMin
  {{
  BCType_t BCType = BCSymmetryPlane ;
  IndexRange_t<3> PointRange =
    {{
      int[3] Begin = [1 ,1,1] ;
      int[3] End   = [25,1,3] ;
    }} ;
  }} ;

BC_t<3,3> JMax = ! ZONE 1 JMax
  {{
  BCType_t BCType = BCOutFlowSubsonic ;
  IndexRange_t<3> PointRange =
    {{
      int[3] Begin = [1 ,65,1] ;
      int[3] End   = [25,65,3] ;
    }} ;
  }} ;
  }} ; ! end Zone1/ZoneBC
}} ; ! end Zone1

! ----- ZONE 2 BC's -----

! CellDimension = 3, PhysicalDimension = 3
```

```

Zone_t<3,3> Zone2 =
  {{
  int VertexSize = [49,65,3] ;
  int CellSize   = [48,64,2] ;
  int VertexSizeBoundary = [0,0,0];

  ZoneType_t ZoneType = Structured;

  ! IndexDimension = 3, PhysicalDimension = 3
  ZoneBC_t<3,3> ZoneBC =
    {{

    ! IndexDimension = 3, PhysicalDimension = 3
    BC_t<3,3> IMax =                                     ! ZONE 2 IMax
      {{
      BCType_t BCType = BCOutflowSubsonic ;
      IndexRange_t<3> PointRange =
        {{
        int[3] Begin = [49,1 ,1] ;
        int[3] End   = [49,65,3] ;
        }} ;
      }} ;      ! end Zone2/ZoneBC/IMax

    BC_t<3,3> JMin =                                     ! ZONE 2 JMin
      {{
      BCType_t BCType = BCWallViscous ;
      IndexRange_t<3> PointRange =
        {{
        int[3] Begin = [1 ,1,1] ;
        int[3] End   = [49,1,3] ;
        }} ;

      ! ListLength = 49*3 = 147
      BCDataSet<147> BCDataSet =
        {{
        BCTypeSimple_t BCTypeSimple = BCWallViscousIsothermal ;

        ! Data array length = ListLength = 147
        BCData_t<147> DirichletData =
          {{
          DataArray_t<real, 1, 147> Temperature =
            {{
            Data(real, 1, 147) = (temperatureprofile(n), n=1,147) ;
            }} ;
          }} ;
    }} ;
  
```

```

    }} ;
}} ;    ! end Zone2/ZoneBC/JMin

BC_t<3,3> JMax =                                ! ZONE 2 JMax
  {{
  BCType_t BCType = BCOutFlowSubsonic ;
  IndexRange_t<3> PointRange =
    {{
    int[3] Begin = [1 ,65,1] ;
    int[3] End   = [49,65,3] ;
    }} ;
  }} ;    ! end Zone2/ZoneBC/JMax

}} ;    ! end Zone2/ZoneBC
}} ;    ! end Zone2
}} ;    ! end TwoZoneCase

```

B.6 Global Reference State

This section provides a description of the freestream reference state. As previously stated, all data is nondimensional including all reference state quantities. The dimensional plate length L and freestream scales ρ_∞ , c_∞ and T_∞ are used for normalization.

The freestream Mach number is 0.5 and the Reynolds number is 10^6 based on freestream velocity and kinematic viscosity and the plate length. These are the only nondimensional parameters included in the reference state. The defining scales for each parameter are also included; these defining scales are nondimensional.

Using consistent normalization, the following nondimensional freestream quantities are defined:

$$\begin{array}{lll}
 \rho'_\infty = 1 & (\rho_0)'_\infty = \rho'_\infty \Gamma^{1/(\gamma-1)} & L' = 1 \\
 c'_\infty = 1 & (c_0)'_\infty = c'_\infty \Gamma^{1/2} & u'_\infty = M_\infty = 0.5 \\
 T'_\infty = 1 & (T_0)'_\infty = T'_\infty \Gamma & v'_\infty = 0 \\
 p'_\infty = 1/\gamma & (p_0)'_\infty = p'_\infty \Gamma^{\gamma/(\gamma-1)} & w'_\infty = 0 \\
 e'_\infty = 1/\gamma(\gamma-1) & (e_0)'_\infty = e'_\infty \Gamma & \nu'_\infty = u'_\infty L' / Re = 5 \times 10^{-7} \\
 h'_\infty = 1/(\gamma-1) & (h_0)'_\infty = h'_\infty \Gamma & \tilde{s}'_\infty = p'_\infty / (\rho'_\infty)^\gamma = 1/\gamma
 \end{array}$$

where $\Gamma \equiv 1 + \frac{\gamma-1}{2} M_\infty^2$ based on $M_\infty = 0.5$ and $\gamma = 1.4$.

Except for the nondimensional parameters Mach number and Reynolds number, all `DataArray_t` entities are abbreviated.

```

CGNSBase_t TwoZoneCase =
  {{

  DataClass_t DataClass = NormalizedByUnknownDimensional ;

```



```

ReferenceState_t ReferenceState =
  {{
Descriptor_t ReferenceStateDescription =
  {{
  Data(char, 1, 10) = "Freestream" ;
  }} ;

dataArray_t<real, 1, 1> Mach =
  {{
  Data(real, 1, 1) = 0.5 ;
  DataClass_t DataClass = NondimensionalParameter ;
  }} ;
dataArray_t<real, 1, 1> Mach_Velocity      = {{ 0.5 }} ;
dataArray_t<real, 1, 1> Mach_VelocitySound = {{ 1 }} ;

dataArray_t<real, 1, 1> Reynolds =
  {{
  Data(real, 1, 1) = 1.0e+06 ;
  DataClass_t DataClass = NondimensionalParameter ;
  }} ;
dataArray_t<real, 1, 1> Reynolds_Velocity      = {{ 0.5 }} ;
dataArray_t<real, 1, 1> Reynolds_Length        = {{ 1. }} ;
dataArray_t<real, 1, 1> Reynolds_ViscosityKinematic = {{ 5.0E-07 }} ;

dataArray_t<real, 1, 1> Density                = {{ 1. }} ;
dataArray_t<real, 1, 1> LengthReference        = {{ 1. }} ;
dataArray_t<real, 1, 1> VelocitySound          = {{ 1. }} ;
dataArray_t<real, 1, 1> VelocityX              = {{ 0.5 }} ;
dataArray_t<real, 1, 1> VelocityY              = {{ 0 }} ;
dataArray_t<real, 1, 1> VelocityZ              = {{ 0 }} ;
dataArray_t<real, 1, 1> Pressure                = {{ 0.714286 }} ;
dataArray_t<real, 1, 1> Temperature            = {{ 1. }} ;
dataArray_t<real, 1, 1> EnergyInternal          = {{ 1.785714 }} ;
dataArray_t<real, 1, 1> Enthalpy                = {{ 2.5 }} ;
dataArray_t<real, 1, 1> EntropyApprox          = {{ 0.714286 }} ;

dataArray_t<real, 1, 1> DensityStagnation      = {{ 1.129726 }} ;
dataArray_t<real, 1, 1> PressureStagnation     = {{ 0.847295 }} ;
dataArray_t<real, 1, 1> EnergyStagnation       = {{ 1.875 }} ;
dataArray_t<real, 1, 1> EnthalpyStagnation     = {{ 2.625 }} ;
dataArray_t<real, 1, 1> TemperatureStagnation = {{ 1.05 }} ;
dataArray_t<real, 1, 1> VelocitySoundStagnation = {{ 1.024695 }} ;

dataArray_t<real, 1, 1> ViscosityKinematic     = {{ 5.0E-07 }} ;
  }} ;

```

```
}} ;          ! end TwoZoneCase
```

B.7 Equation Description

This section provides a description of the flow equations used to solve the problem. The flow equation set is turbulent, compressible 3-D Navier-Stokes with the Spalart-Allmaras (S-A) one-equation turbulence model. The thin-layer Navier-Stokes diffusion terms are modeled; only diffusion in the j -coordinate direction is included.

A perfect gas assumption is made with $\gamma = 1.4$; based on the normalization used in this database, the nondimensional scales defining γ are $(c_p)' = 1/(\gamma-1)$ and $(c_v)' = 1/\gamma(\gamma-1)$. The molecular viscosity is obtained from Sutherland's Law. In order to nondimensionalize the viscosity formula, standard atmospheric conditions are assumed (i.e., $T_\infty = 288.15$ K). A constant Prandtl number assumption is made for the thermal conductivity coefficient; $Pr = 0.72$. The defining scales of Pr are evaluated at freestream conditions; the nondimensional thermal conductivity is $k'_\infty = \mu'_\infty(c_p)'/Pr$.

The Navier-Stokes equations are closed with an eddy viscosity assumption using the S-A model. A turbulent Prandtl number of $Pr_t = 0.9$ is prescribed. All parameters not provided are defaulted.

Except for the nondimensional parameters γ and Pr , all `DataArray_t` entities are abbreviated.

```
CGNSBase_t TwoZoneCase =
  {{
  int CellDimension = 3 ;
  int PhysicalDimension = 3 ;

  DataClass_t DataClass = NormalizedByUnknownDimensional ;

  ! CellDimension = 3
  FlowEquationSet_t<3> FlowEquationSet =
    {{
    int EquationDimension = 3

    ! CellDimension = 3 ;
    GoverningEquations_t<3> GoverningEquations =
      {{
      GoverningEquationsType_t GoverningEquationsType = NSTurbulent ;

      int[6] DiffusionModel = [0,1,0,0,0,0] ;
    }} ;

  GasModel_t GasModel =
    {{
    GasModelType_t GasModelType = CaloricallyPerfect ;

    DataArray_t<real, 1, 1> SpecificHeatRatio =
      {{
```

```

    Data(real, 1, 1) = 1.4 ;
    DataClass_t DataClass = NondimensionalParameter ;
  }} ;
  DataArray_t<real, 1, 1> SpecificHeatRatio_Pressure = {{ 2.5 }} ;
  DataArray_t<real, 1, 1> SpecificHeatRatio_Volume   = {{ 1.785714 }} ;
  }} ;

  ViscosityModel_t ViscosityModel =
  {{
    ViscosityModelType_t ViscosityModelType = SutherLandLaw ;

    DataArray_t<real, 1, 1> SutherLandLawConstant      = {{ 0.38383 }} ;
    DataArray_t<real, 1, 1> TemperatureReference       = {{ 1.05491 }} ;
    DataArray_t<real, 1, 1> ViscosityMolecularReference = {{ 5.0E-07 }} ;
  }} ;

  ThermalConductivityModel_t ThermalConductivityModel =
  {{
    ThermalConductivityModelType_t ThermalConductivityModelType =
      ConstantPrandtl ;

    DataArray_t<real, 1, 1> Prandtl =
    {{
      Data(real, 1, 1) = 0.72 ;
      DataClass_t DataClass = NondimensionalParameter ;
    }} ;
    DataArray_t<real, 1, 1> Prandtl_ThermalConductivity = {{ 1.73611E-0.6 }} ;
    DataArray_t<real, 1, 1> Prandtl_ViscosityMolecular   = {{ 5.0E-0.7 }} ;
    DataArray_t<real, 1, 1> Prandtl_SpecificHeatPressure = {{ 2.5 }} ;
  }} ;

  TurbulenceClosure_t TurbulenceClosure =
  {{
    TurbulenceClosureType_t TurbulenceClosureType = EddyViscosity ;

    DataArray<real, 1, 1> PrandtlTurbulent = {{ 0.90 }} ;
  }} ;

  TurbulenceModel_t<3> TurbulenceModel =
  {{
    TurbulenceModelType_t TurbulenceModelType =
      OneEquation_SpalartAllmaras ;

    int[6] DiffusionModel = [0,1,0,0,0,0] ;
  }} ;

```

```
    }} ;      ! end FlowEquationSet  
  }} ;      ! TwoZoneCase
```

Index

AdditionalUnits_t, 62
AngleUnits_t, 62
Area_t, 153
AverageInterface_t, 137
Axisymmetry_t, 103

Base, 79
BC_t, 145
BCData_t, 151
BCDataSet_t, 149
BCProperty_t, 152
BCTYPE_t, 154

CellDimension, 81, 85
CellSize, 85
CGNSBase_t, 79

dataArray_t, 67
DataClass_t, 61, 67
DimensionalExponents_t, 67
DimensionalUnits_t, 67
DataConversion_t, 68
Descriptor_t, 61
DimensionalExponents_t, 63
DimensionalUnits_t, 62
DirichletData, 160

ElectricCurrentUnits_t, 62
ElementRange, 97
Elements_t, 96
ElementSizeBoundary, 97
ElementType_t, 97

FamilyName, 83, 111, 145
FlowSolution_t, 105
Fortran indexing, 94

GridConnectivity_t, 125
GridConnectivity1to1_t, 120
GridConnectivityProperty_t, 123, 136
GridCoordinates_t, 91
GridLocation, 112, 127
GridLocation_t, 64, 107

IndexArray_t, 64
IndexDimension, 64, 81, 85
IndexRange_t, 65
Interpolation, 128

LengthUnits_t, 62
LuminousIntensityUnits_t, 62

MassUnits_t, 62
MKSI, 63

NeumannData, 160

OversetHoles_t, 138

ParentElements, 97
ParentElementsPosition, 97
Periodic_t, 136
PhysicalDimension, 81, 85

Rind_t, 65
RindPlanes, 65, 92, 97
RotatingCoordinates_t, 104

Scope rules, 69, 87
Structured subregion, 114
SubstanceAmountUnits_t, 62
Surface definition, 115

TemperatureUnits_t, 62
TimeUnits_t, 62

Unstructured subregion, 115

VertexSize, 85
VertexSizeBoundary, 85

WallFunctionWallFunction_t, 153

Zone_t, 83
ZoneBC_t, 143
ZoneGridConnectivity_t, 119
ZoneSubRegion_t, 111
ZoneType_t, 83